



SVG

User Manual

version 4



REMOVE AND KEEP THIS
SHEET SOMEWHERE SAFE

Every machine leaves our factory with two levels of password protection. We recommend that you remove this sheet in order to establish your own security.

User Password - unix
System Password - linux

Table of Contents

Section 1 - Introduction	1-1
1.1 Intended Use	1-1
1.2 Release Details	1-1
1.3 Warranty Details	1-1
1.4 Returned Goods Policy.....	1-1
1.5 Movement or Resale of Mold-Masters Products or Systems	1-1
1.6 Copyright	1-2
1.7 Units of Measure and Conversion Factors	1-2
1.8 Trademarks and Patents	1-3
 Section 2 - Global Support	 2-1
2.1 Manufacturing Facilities	2-1
2.2 Regional Offices	2-1
2.3 International Representatives.....	2-2
 Section 3 - Safety.....	 3-1
3.1 Introduction	3-1
3.2 Safety Hazards	3-2
3.3 Operational Hazards.....	3-5
3.4 General Safety Symbols.....	3-7
3.5 Wiring Check	3-8
3.6 Lockout Safety.....	3-9
3.7 Electrical Lockout	3-10
3.7.1 Energy Forms and Lockout Guidelines.....	3-11
3.8 Grounded Earth Connections - SVG	3-12
3.9 Grounded Earth Connections - Compact SVG	3-12
3.10 Disposal.....	3-12
3.11 SVG/Compact SVG Controller User Hazards.....	3-13
3.11.1 Operational Environment	3-14
 Section 4 - Overview	 4-1
4.1 Introduction	4-1
4.1.1 SVG Controller.....	4-1
4.1.2 Compact SVG Controller	4-1
4.2 Screen Layout	4-2
4.2.1 Information.....	4-2
4.2.2 Control	4-2
4.2.3 Navigation.....	4-2
4.3 SVG Main Page – Display Options.....	4-3
4.4 Compact SVG Main Screen – Display Options	4-4
4.5 The User Interface	4-5
4.6 Screensaver	4-5

Section 5 - Setup	5-1
5.1 Setup the Controller.....	5-2
5.2 Create a First Tool	5-3
5.2.1 Configure Zone Types	5-5
5.3 Configure the Tool	5-7
5.4 Configure System Settings	5-7
5.5 Set the Inputs	5-8
5.5.1 Set Screw Input	5-9
5.5.2 Screw Calibration Steps	5-11
5.6 Set Open / Close Triggers	5-12
5.7 Set Gate Open / Close Values.....	5-14
5.8 Other Utility Functions	5-15
5.9 Setup Examples	5-16
5.9.1 Use Time Values Alone.....	5-16
5.9.2 Screw Position Alone	5-16
5.9.3 Use a Combination of Both Time and Position	5-17
 Section 6 - Operation	 6-1
6.1 Main Screen	6-1
6.2 Switch On / Switch Off.....	6-1
6.2.1 SVG Controller.....	6-1
6.2.2 Compact SVG Controller	6-2
6.3 Run and Stop.....	6-2
 Section 7 - Maintenance.....	 7-1
7.1 Replacement Parts	7-1
7.2 Equipment Inspection	7-1
7.3 Fuses.....	7-1
7.3.1 Supplementary Fuse - SVG.....	7-1
7.3.2 Controller Card Fuses - SVG.....	7-2
7.3.3 Controller Card Fuse - Compact SVG	7-2
 Section 8 - Troubleshooting	 8-1
8.1 Fault and Warning Messages	8-1
 Section 9 - Hot Runner Controller Wiring Details.....	 9-1
9.1 Outputs	9-1
9.2 Output Rating	9-1
9.3 External Wiring Connections	9-2
9.3.1 Inputs - North American Version.....	9-2
9.3.2 Inputs - European Version	9-3
9.4 Handshake Inputs (Optional).....	9-3
 Index	 I

List of Tables

Table 1-1 Release Details.....	1-1
Table 1-2 Units of Measure and Conversion Factors	1-2
Table 3-1 Safety Hazards	3-3
Table 3-2 Typical Safety Symbols.....	3-7
Table 3-3 Energy Forms, Energy Sources and General Lockout Guidelines	3-11
Table 5-1 Cards - Setup.....	5-4
Table 5-2 Tool Parameters.....	5-7
Table 5-3 Open and Close Trigger Options	5-8
Table 5-4 Utility Functions	5-15
Table 7-1 Supplementary Fuse.....	7-1
Table 7-2 Controller Card Fuses.....	7-2
Table 7-3 Controller Card Fuse	7-2
Table 8-1 Troubleshooting	8-1
Table 9-1 Connector 1 Inputs	9-2
Table 9-2 Connector 2 Inputs	9-2
Table 9-3 HAN16 Connector Inputs.....	9-3

List of Figures

Figure 3-1 Injection molding machine hazard areas.....	3-2
Figure 3-2 Ground bar in SVG controller	3-12
Figure 4-1 10 zone display	4-3
Figure 4-2 24 zone display	4-3
Figure 4-3 Tabular display	4-3
Figure 4-4 Display with 10 zones	4-4
Figure 4-5 Display with 12 zones	4-4
Figure 4-6 Tabular display	4-4
Figure 5-1 Card detect routine.....	5-3
Figure 5-2 Analog Screw Input now available	5-10
Figure 5-3 Enter open and close values for each gate.....	5-14
Figure 5-4 Preview screen.....	5-14
Figure 6-1 Main screen.....	6-1
Figure 6-2 SVG controller main switch	6-1
Figure 6-3 Compact SVG controller main switch.....	6-2
Figure 7-1 Remove screws.....	7-2
Figure 7-2 Fuse bank - compact SVG controller	7-2
Figure 9-1 AMP04 connector number 1.....	9-2
Figure 9-2 AMP04 connector number 2.....	9-2

Section 1 - Introduction

The purpose of this manual is to assist users in the integrations, operation and maintenance of the SVG [Sequence Valve Gate] and compact SVG controllers. This manual is designed to cover most system common configurations. If you need additional information specific to your system please contact your representative or a *Mold-Masters* office whose location can be found in the “Global Support” section.

1.1 Intended Use

The SVG and compact SVG controllers have been designed as a multi-channel valve gate controller for use in hot runner plastic molding equipment. They can optionally use feedback from position indicators within the gates to confirm successful gate operation, and they are designed to be safe during normal operation. Any other uses would fall outside the engineered intent of this machine which may be a safety hazard and would void any and all warranties.

This manual is written for use by skilled persons who are familiar with injection molding machinery the controls. Operators should be familiar with plastic injection molding machines and the controls of such equipment. Maintenance persons should have sufficient understanding of electrical safety to appreciate the dangers of 3-phase supplies. They should know how to take appropriate measures to avoid any danger from electrical supplies.

1.2 Release Details

Table 1-1 Release Details		
Document Number	Release Date	Version
SVG-UM-EN-00-04	June 2019	04

1.3 Warranty Details

For current warranty information please refer to the documents available from our website: <https://www.milacron.com/mold-masters-warranty/> or contact your *Mold-Masters* representative.

1.4 Returned Goods Policy

Please do not return any parts to *Mold-Masters* without a pre-authorization and a return authorization number supplied by *Mold-Masters*.

Our policy is one of continuous improvement and we reserve the right to alter product specifications at any time without giving notice.

1.5 Movement or Resale of Mold-Masters Products or Systems

This documentation is intended for use in the country of destination for which the product or system was purchased.

Mold-Masters takes no responsibility for documentation of products or systems if they are relocated or resold outside the intended country of destination, as stated on the accompanying invoice and/or waybill.

1.6 Copyright

© 2020 Mold-Masters (2007) Limited. All Rights Reserved. *Mold-Masters®* and the *Mold-Masters* logo are trademarks of Mold-Masters.

1.7 Units of Measure and Conversion Factors



NOTE

The dimensions given in this manual are from original manufacturing drawings.

All values in this manual are in S.I. units or subdivisions of these units. Imperial units are given in parenthesis immediately after the S.I. units.

Table 1-2 Units of Measure and Conversion Factors		
Abbreviation	Unit	Conversion Value
bar	Bar	14.5 psi
in.	Inch	25.4 mm
kg	Kilogram	2.205 lb
kPa	Kilopascal	0.145 psi
gal	Gallon	3.785 l
lb	Pound	0.4536 kg
lbf	Pound force	4.448 N
lbf.in.	Pound force inch	0.113 Nm
l	Litre	0.264 gallon
min	Minute	
mm	Millimeter	0.03937 in.
mΩ	Milli Ohm	
N	Newton	0.2248 lbf
Nm	Newton Meter	8.851 lbf.in.
psi	Pound per square inch	0.069 bar
psi	Pound per square inch	6.895 kPa
rpm	Revolutions per minute	
s	Second	
°	Degree	
°C	Degree Celsius	0.556 (°F -32)
°F	Degree Fahrenheit	1.8 °C +32

1.8 Trademarks and Patents

ACCU-VALVE, DURA, E-MULTI, FLEX-DURA FLEX-SERIES, FUSION-SERIES, HOT EDGE, MASTERPROBE, MASTER-SHOT, MOLD-MASTERS, MELT-DISK, MOLD-MASTERS ACADEMY, MASTER-SERIES, MASTERSOLUTION, MASTERSPEED, MERLIN, MOLD-MASTERS SYSTEM, MPET, STACK-LINK, are the registered trademarks of MOLD-MASTERS (2007) LIMITED.

Information contained herein is, to our best knowledge, true and accurate, but all recommendations or suggestions are made without guarantee. Since the conditions of use are beyond our control, *Mold-Masters* disclaims any liability incurred in connection with the use of our products and information contained herein. No person is authorized to make any statement or recommendation not contained herein, and any such statement or recommendation so made shall not bind *Mold-Masters*. Furthermore, nothing contained herein shall be construed as a recommendation to use any product in conflict with existing patents covering any products or its use, and no license implied or in fact granted herein under the claims of any patents.

No part of this publication may be reproduced or transmitted in any form or by any means, electronic or mechanical, including photocopy, recording, or any information storage and retrieval system without permission in writing from the publisher. All details, standards and specifications may be altered in accordance with technical development without prior notification.

May be manufactured under one or more of the following U.S. Patents:

5792493, 5795599, 5820899, 5843361, 5849343, 5853777, 5935615, 5935616, 5935621, 5942257, 5952016, 5980236, 6009616, 6017209, 6030198, 6030202, 6062841, 6074191, 6077067, 6079972, 6095790, 6099780, 6113381, 6135751, 6162043, 6162044, 6176700, 6196826, 6203310, 6230384, 6270711, 6274075, 6286751, 6302680, 6318990, 6323465, 6348171, 6350401, 6394784, 6398537, 6405785, 6440350, 6454558, 6447283, 6488881, 6561789, 6575731, 6625873, 6638053, 6648622, 6655945, 6675055, 6688875, 6701997, 6739863, 6752618, 6755641, 6761557, 6769901, 6776600, 6780003, 6789745, 6830447, 6835060, 6840758, 6852265, 6860732, 6869276, 6884061, 6887418, 6890473, 6893249, 6921257, 6921259, 6936199, 6945767, 6945768, 6955534, 6962492, 6971869, 6988883, 6992269, 7014455, 7018197, 7022278, 7025585, 7025586, 7029269, 7040378, 7044191, 7044728, 7048532, 7086852, 7105123, 7108502, 7108503, 7115226, 7118703, 7118704, 7122145, 7125242, 7125243, 7128566, 7131832, 7131833, 7131834, 7134868, 7137806, 7137807, 7143496, 7156648, 7160100, 7160101, 7165965, 7168941, 7168943, 7172409, 7172411, 7175419, 7175420, 7179081, 7182591, 7182893, 7189071, 7192268, 7192270, 7198740, 7201335, 7210917, 7223092, 7238019, 7244118, 7252498, 7255555, 7258536, 7270538, 7303720, 7306454, 7306455, 7314367, 7320588, 7320589, 7320590, 7326049, 7344372, 7347684, 7364425, 7364426, 7370417, 7377768, 7381050, 7396226, 7407379, 7407380, 7410353, 7410354, 7413432, 7416402, 7438551, 7462030, 7462031, 7462314, 7465165, 7470122, 7507081, 7510392, 7513771, 7513772, 7517214, 7524183, 7527490, 7544056, 7547208, 7553150, 7559760, 7559762, 7565221, 7581944, 7611349, 7614869, 7614872, 7618253, 7658605, 7658606, 7671304, 7678320, 7686603, 7703188, 7713046, 7722351, 7731489, 7753676, 7766646, 7766647, 7775788, 7780433, 7780434, 7794228, 7802983, 7803306, 7806681, 7824163, 7845936, 7850442, 7874833, 7877163, 7891969, 7918660, 7918663, 7931455, 7963762, 7988445, 7998390, 8062025, 8066506, 8113812, 8142182, 8152513, 8167608, 8202082, 8206145, 8210842, 8241032, 8280544, 8282386, 8308475, 8308476, 8328546, 8353697, 8414285, 8425216, 8449287, 8465688, 8469687, 8475155, 8475158, 8480391, 8568133, 8690563, 8715547, 8753102, 8757998, 8758002, 8845321, 8899964, 8940202, 8985997, 9004906, 9028243, 9073246, 9186830, 9186833, 9227351, 9248593, 9272455, 9327436, D525592, RE38265, RE38396, RE38920, RE39935, RE40478, RE40952, RE41536E, RE41648E+ Pending.

© 2019 MOLD-MASTERS (2007) LIMITED, ALL RIGHTS RESERVED

Section 2 - Global Support

2.1 Manufacturing Facilities

GLOBAL HEADQUARTERS

CANADA

Mold-Masters (2007) Limited
233 Armstrong Avenue
Georgetown, Ontario
Canada L7G 4X5
tel: +1 905 877 0185
fax: +1 905 877 6979
canada@moldmasters.com

SOUTH AMERICAN HEADQUARTERS

BRAZIL

Mold-Masters do Brasil Ltda.
R. James Clerk Maxwel,
280 – Techno Park, Campinas
São Paulo, Brazil, 13069-380
tel: +55 19 3518 4040
brazil@moldmasters.com

UNITED KINGDOM & IRELAND

Mold-Masters (UK) Ltd
Netherwood Road
Rotherwas Ind. Est.
Hereford, HR2 6JU
United Kingdom
tel: +44 1432 265768
fax: +44 1432 263782
uk@moldmasters.com

EUROPEAN HEADQUARTERS

GERMANY / SWITZERLAND

Mold-Masters Europa GmbH
Postfach/P.O. Box 19 01 45
76503 Baden-Baden, Germany
Neumattring 1
76532 Baden-Baden, Germany
tel: +49 7221 50990
fax: +49 7221 53093
germany@moldmasters.com

INDIA

Mold-Masters Technologies
Private Limited
247, Alagesan Road,
Shiv Building, Saibaba Colony,
Coimbatore T. N.
India 641 011
tel: +91 422 423 4888
fax: +91 422 423 4800
india@moldmasters.com

USA

Mold-Masters Injectioneering LLC
29111 Stephenson Highway
Madison Heights, MI 48071, USA
tel: +1 800 450 2270 (USA only)
tel: +1 (248) 544-5710
fax: +1 (248) 544-5712
usa@moldmasters.com

ASIAN HEADQUARTERS

CHINA/HONG KONG/TAIWAN

Mold-Masters (KunShan) Co, Ltd
Zhao Tian Rd
Lu Jia Town, KunShan City
Jiang Su Province
People's Republic of China
tel: +86 512 86162882
fax: +86 512-86162883
china@moldmasters.com

JAPAN

Mold-Masters K.K.
1-4-17 Kurikidai, Asaoku
Kawasaki, Kanagawa
Japan, 215-0032
tel: +81 44 986 2101
fax: +81 44 986 3145
japan@moldmasters.com

2.2 Regional Offices

AUSTRIA / East and South East Europe

Mold-Masters Handelsges.m.b.H.
Pyhrnstrasse 16
A-4553 Schlierbach
Austria
tel: +43 7582 51877
fax: +43 7582 51877 18
austria@moldmasters.com

ITALY

Mold-Masters Italia
Via Germania, 23
35010 Vigonza (PD)
Italy
tel: +39 049/5019955
fax: +39 049/5019951
italy@moldmasters.com

CZECH REPUBLIC

Mold-Masters Europa GmbH
Hlavni 823
75654 Zubri
Czech Republic
tel: +420 571 619 017
fax: +420 571 619 018
czech@moldmasters.com

KOREA

Mold-Masters Korea Ltd.
E dong, 2nd floor, 2625-6,
Jeongwang-dong, Siheung
City, Gyeonggi-do, 15117,
South Korea
Tel: +82-31-431-4756
korea@moldmasters.com

FRANCE

Mold-Masters France
ZI la Marinière,
2 Rue Bernard Palissy
91070 Bondoufle, France
tel: +33 (0) 1 78 05 40 20
fax: +33 (0) 1 78 05 40 30
france@moldmasters.com

MEXICO

Milacron Mexico Plastics Services
S.A. de C.V.
Circuito El Marques norte #55
Parque Industrial El Marques
El Marques, Queretaro C.P. 76246
Mexico
tel: +52 442 713 5661 (sales)
tel: +52 442 713 5664 (service)
mexico@moldmasters.com

Regional Offices - continued

POLAND

Mold-Masters Europa GmbH
Skr. Pocztowa 59
00-908 Warszawa
Poland
tel: +48 (0) 66 91 80 888
fax: +48 (0) 66 91 80 208
poland@moldmasters.com

SINGAPORE*

Mold-Masters Singapore PTE. Ltd.
No 48 Toh Guan Road East
#06-140 Enterprise Hub
Singapore 608586
Republic of Singapore
tel: +65 6261 7793
fax: +65 6261 8378
singapore@moldmasters.com
*Coverage includes Southeast
Asia, Australia, and New Zealand

SPAIN

Ferromatik Milacron /
Mold Masters Europa GmbH
C/. Enric Morera, 7
Polig. Ind. Foinvasa
08110 Montcada i Reixac
Barcelona, Spain
tel: +34 93 575 41 29
fax: +34 93 575 34 19
spain@moldmasters.com

TURKEY

Mold-Masters Europa GmbH
Merkezi Almanya Türkiye
İstanbul Şubesi
Alanaldı Caddesi Bahçelerarası
Sokak No: 31/1
34736 İçerenköy-Ataşehir
İstanbul, Turkey
tel: +90 216 577 32 44
fax: +90 216 577 32 45
turkey@moldmasters.com

2.3 International Representatives

ARGENTINA

Sollwert S.R.L.
tel: +54 11 4786 5978
e: sollwert@fibertel.com.ar

DENMARK*

Englmayer A/S
tel: +45 46 733847
e: support@englmayer.dk
*Coverage includes Norway and
Sweden.

BELARUS

HP Promcomplex
tel: +375 29
683-48-99 e:
info@mold.by

BULGARIA

Mold-Trade OOD
tel: +359 82 821 054
e: contact@mold-trade.com

ISRAEL

ASAF Industries
tel: +972 3 5581290
e: sales@asaf.com

FINLAND

Oy Scalar Ltd.
tel: +358 10 387 2955
e: info@scalar.fi

GREECE

Ionian Chemicals S.A.
tel: +30 210 6836918-9
e: m.pavlou@ionianchemicals.com

RUSSIA

System LLC
tel: +7 (495) 199-14-51
e: moldmasters@system.com.ru

PORTUGAL

Gecim LDA
tel: +351 244 575600
e: gecim@gemic.pt

ROMANIA

Tehnic Mold Trade SRL
tel: +4 021 230 60 51
e: contact@matritehightech.ro

SLOVENIA

RD Picta Tehnologije d.o.o.
tel: +386 59 969 117
e: info@picta.si

Section 3 - Safety

3.1 Introduction

Please be aware that the safety information provided by *Mold-Masters* does not absolve the integrator and employer from understanding and following international and local standards for safety of machinery. It is the responsibility of the end integrator to integrate the final system, provide necessary e-stop connections, safety interlocks and guarding, to choose the appropriate electrical cable for the region of use and to ensure compliance with all relevant standards.

It is the responsibility of the employer to:

- Properly train and instruct its personnel in the safe operation of equipment, including the use of all the safety devices.
- Provide its personnel with all necessary protective clothing, including such items as a face shield and heat resistant gloves.
- Ensure the original and continuing competence of personnel caring for, setting up, inspecting and maintaining injection molding equipment.
- Establish and follow a program of periodic and regular inspections of injection molding equipment to ensure it is in safe operating condition and proper adjustment.
- Ensure that no modifications, repairs or rebuild of portions are made to the equipment that reduces the level of safety existing at time of manufacture or remanufacture.

3.2 Safety Hazards



WARNING

Also refer to all machine manuals and local regulations and codes for safety information.

The following safety hazards are most commonly associated with injection molding equipment. See European Standard EN201 or American Standard ANSI/SPI B151.1.

Refer to the illustration of hazard areas below when reading the Safety Hazards Table 3-1 on page 3-3.

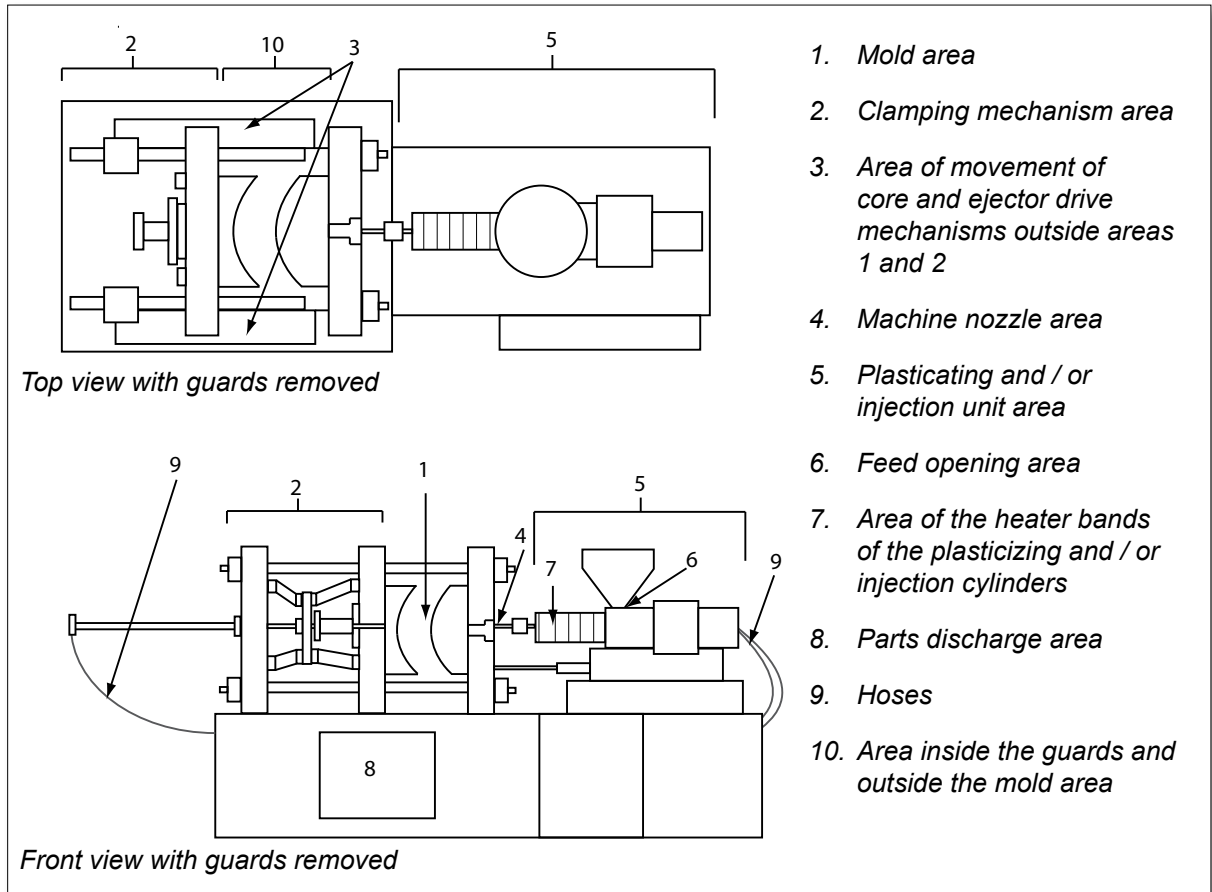

Figure 3-1 Injection molding machine hazard areas

Safety Hazards - continued

Table 3-1 Safety Hazards	
Hazard Area	Potential Hazards
<p>Mold Area Area between the platens. See Figure 3-1 area 1</p>	<p>Mechanical Hazards Crushing and / or shearing and / or impact hazards caused by:</p> <ul style="list-style-type: none"> • Movement of the platen. • Movements of the injection barrel(s) into the mold area. • Movements of cores and ejectors and their drive mechanisms. • Tie bar motion. <p>Thermal Hazards Burns and / or scalds due to operating temperature of:</p> <ul style="list-style-type: none"> • The mold heating elements. • Material released from/through the mold.
<p>Clamping Mechanism Area See Figure 3-1 area 2</p>	<p>Mechanical Hazards Crushing and / or shearing and / or impact hazards caused by:</p> <ul style="list-style-type: none"> • Movement of the platen. • Movement of the drive mechanism of the platen. • Movement of the core and ejector drive mechanism.
<p>Movement of Drive Mechanisms Outside the Mold Area and Outside the Clamping Mechanism Area See Figure 3-1 area 3</p>	<p>Mechanical Hazards Mechanical hazards of crushing, shearing and / or impact caused by the movements of:</p> <ul style="list-style-type: none"> • Core and ejector drive mechanisms.
<p>Nozzle Area The nozzle area is the area between the barrel and the sprue bushing. See Figure 3-1 area 4</p>	<p>Mechanical Hazards Crushing, shearing hazards and / or impact hazards caused by:</p> <ul style="list-style-type: none"> • Forward movement of the plasticizing and / or injection unit including nozzle. • Movements of parts of the power-operated nozzle shutoff and their drives. • Over pressurization in the nozzle. <p>Thermal Hazards Burns and or scalds due to operating temperature of:</p> <ul style="list-style-type: none"> • The nozzle. • Material discharging from the nozzle.
<p>Plasticizing and / or Injection Unit Area Area from the adapter / barrel head / end cap to the extruder motor above the sled including the carriage cylinders. See Figure 3-1 area 5</p>	<p>Mechanical Hazards Crushing, shearing and / or drawn-into hazards caused by:</p> <ul style="list-style-type: none"> • Unintentional gravity movements e.g. for machines with plasticizing and / or injection unit positioned above the mold area. • The movements of the screw and / or the injection plunger in the cylinder accessible through the feed opening. • Movement of the carriage unit. <p>Thermal Hazards Burns and / or scalds due to operating temperature of:</p> <ul style="list-style-type: none"> • The plasticizing and / or injection unit. • The heating elements e.g. heater bands. • The material and / or vapors discharging from the vent opening, feed throat or hopper. <p>Mechanical and / or Thermal Hazard</p> <ul style="list-style-type: none"> • Hazards due to reduction in mechanical strength of the plasticizing and / or injection cylinder due to overheating.
<p>Feed Opening See Figure 3-1 area 6</p>	<p>Pinching and crushing between injection screw movement and housing.</p>

Safety Hazards - continued

Table 3-1 Safety Hazards	
Hazard Area	Potential Hazards
Area of the Heater Bands of the Plasticizing and / or Injection Cylinders See Figure 3-1 area 7	Burns and / or scalds due to operating temperature of: <ul style="list-style-type: none"> • The plasticizing and / or injection unit. • The heating elements e.g. heater bands. • The material and / or vapors discharging from the vent opening, feed throat or hopper.
Parts Discharge Area See Figure 3-1 area 8	Mechanical Hazards Accessible Through the Discharge Area Crushing, shearing and / or impact hazards caused by: <ul style="list-style-type: none"> • Closing movement of the platen. • Movements of cores and ejectors and their drive mechanisms. Thermal Hazards Accessible through the discharge area Burns and or scalds due to operating temperature of: <ul style="list-style-type: none"> • The mold. • Heating elements of the mold. • Material released from / through the mold.
Hoses See Figure 3-1 area 9	<ul style="list-style-type: none"> • Whipping action caused by hose assembly failure. • Possible release of fluid under pressure that can cause injury. • Thermal hazards associated with hot fluid.
Area Inside the Guards and Outside the Mold Area See Figure 3-1 area 10	Crushing and / or shearing and / or impact hazards caused by: <ul style="list-style-type: none"> • Movement of the platen. • Movement of the drive mechanism of the platen. • Movement of the core and ejector drive mechanism. • Clamp opening movement.
Electrical Hazards	<ul style="list-style-type: none"> • Electrical or electromagnetic disturbance generated by the motor control unit. • Electrical or electromagnetic disturbance that can cause failures in the machine control systems and adjacent machine controls. • Electrical or electromagnetic disturbance generated by the motor control unit.
Hydraulic Accumulators	High pressure discharge.
Power Operated Gate	Crush or impact hazards caused by the movement of the power operated gates.
Vapors and Gases	Certain processing conditions and / or resins can cause hazardous fumes or vapors.



3.3 Operational Hazards

WARNINGS

- Refer to all machine manuals and local regulations and codes for safety information.
- The equipment supplied is subjected to high injection pressures and high temperatures. Ensure that extreme caution is observed in the operation and maintenance of the injection molding machines.
- Only fully trained personnel should operate or maintain equipment.
- Do not operate the equipment with unconfined long hair, loose clothing or jewelry, including name badges, neckties, etc. These may get caught in the equipment and can cause death or serious injury.
- Never disable or bypass a safety device.
- Ensure that the protective guards are placed around the nozzle to prevent the material from splashing or drooling.
- A burn hazard exists from material during routine purging. Wear heat-resistant personal protective equipment (PPE) to prevent burns from contact with hot surfaces or splatter of hot material and gases.
- Material purged from machine may be extremely hot. Ensure protective guards are in place around the nozzle to prevent material from splashing. Use proper personal protective equipment.
- All operators should wear personal protective equipment, such as face shields and use heat resistant gloves when working around the feed inlet, purging the machine or cleaning the gates of the mold.
- Remove purged material from the machine immediately.
- Decomposing or burning material could result in noxious gases being emitted from the purged material, feed inlet or mold.
- Ensure proper ventilation and exhaust systems are in place to help prevent inhalation of harmful gases and vapors.
- Consult manufacturer's Material Safety Data Sheets (MSDS).
- Hoses fitted to the mold will contain high or low temperature fluids or air under high pressure. The operator must shut down and lockout these systems as well as relieving any pressure before performing any work with these hoses. Regularly inspect and replace all flexible hoses and restraints.
- Water and / or hydraulics on the mold may be in close proximity to electrical connections and equipment. Water leakage may cause an electrical short circuit. Hydraulic fluid leakage may cause a fire hazard. Always keep water and / or hydraulic hoses and fittings in good condition to avoid leaks.
- Never perform any work on the mold machine unless the hydraulic pump has been stopped.
- Check frequently for possible oil leaks / water leaks. Stop the machine and make repairs.



Operational Hazards - continued**WARNING**

- Make sure that the cables are connected to the correct motors. Cables and motors are clearly labeled. Reversing the cables can result in unexpected and uncontrolled motion causing a safety risk or damage to the machine.
- A crushing hazard exists between the nozzle and mold melt inlet during carriage forward motion.
- A possible shearing hazard exists between the edge of the injection guard and the injection housing during injection.
- The open feed port could present a hazard to a finger or a hand inserted during operation of the machine.
- The electric servo motors could overheat presenting a hot surface which could cause burns to someone touching it.
- The barrel, barrel head, nozzle, heater bands and mold components are hot surfaces which could result in burns.
- Keep flammable liquids or dust away from the hot surfaces as they could ignite.
- Follow good housekeeping procedures and keep floors clean to prevent slips, trips and falls due to spilled material on the work floor.
- Apply engineering controls or hearing conservation programs as necessary to control noise.
- When doing any work on the machine that requires moving and lifting the machine, ensure that lifting equipment (eyebolts, fork lift truck, cranes, etc.) will have sufficient capacity to handle mold, auxiliary injection unit or Hot Runner weight.
- Connect all lifting devices and support the machine using a crane of adequate capacity before commencing work. Failure to support the machine can result in severe injury or death.
- Mold cable from the controller to the mold must be removed before servicing the mold.

3.4 General Safety Symbols

Table 3-2 Typical Safety Symbols	
Symbol	General Description
	General – Warning Indicates an immediate or potentially hazardous situation, which if not avoided, could result in a serious injury or death, and / or damage to equipment.
	Warning – Barrel Cover Grounding Strap Lockout / tagout procedures must be followed before removing the barrel cover. Barrel cover can become energized upon removal of grounding straps and contact can result in death or serious injury. Grounding straps must be reconnected before reconnecting power to machine.
	Warning – Crushing and / or Impact Points Contact with moving parts can cause serious crushing injury. Always keep guards in place.
	Warning – Crush Hazard Closing Mold
	Warning – Hazardous Voltage Contact with hazardous voltages will cause death or serious injury. Turn off power and review electrical schematics before servicing equipment. May contain more than one live circuit. Test all circuits before handling to make sure circuits have been de-energized.
	Warning – High Pressure Overheated fluids may cause severe burns. Discharge pressure before disconnecting water lines.
	Warning – High Pressure Accumulator Sudden release of high pressure gas or oil can cause death or serious injury. Discharge all gas and hydraulic pressure before disconnecting or disassembling accumulator.
	Warning – Hot Surfaces Contact with exposed hot surfaces will cause serious burn injury. Wear protective gloves when working near these areas.
	Mandatory – Lockout / Tagout Ensure that all energies are properly locked out, and remain locked out until the service work is completed. Servicing equipment without disabling all internal and external power sources can cause death or serious injury. De-energize all internal and external power sources (electrical, hydraulic, pneumatic, kinetic, potential, and thermal).
	Warning – Molten Material Splashing Hazard Molten material or high pressure gas can cause death or severe burns. Wear personal protective equipment while servicing the feed throat, nozzle, mold areas and when purging the injection unit.
	Warning – Read Manual Before Operation Personnel should read and understand all instructions in the manuals before working on equipment. Only properly trained personnel should operate the equipment.
	Warning – Slip, Trip or Fall Hazard Do not climb on equipment surfaces. Serious slip, trip, or fall injuries can result from personnel climbing on equipment surfaces.

General Safety Symbols - continued

Table 3-2 Typical Safety Symbols	
Symbol	General Description
	Caution Failure to follow instructions may damage equipment.
	Important Indicates additional information or used as a reminder.

3.5 Wiring Check



CAUTION

System Mains Supply Wiring:

- Before connecting the system to a power supply, it is important to check that the wiring between the system and the power supply has been done correctly.
- Particular attention must be given to the current rating of the power supply. For example, if a controller is rated at 63A, then the power supply must also be rated at 63A.
- Check that the phases of power supply are wired correctly.

Controller to Mold Wiring:

- For separate power and thermocouple connections, ensure that the power cables are never connected to the thermocouple connectors and vice-versa.
- For mixed power and thermocouple connections, ensure that the power and thermocouple connections have not been wired incorrectly.

Communications Interface and Control Sequence:

- It is the customer's responsibility to verify functionality of any custom machine interface at safe speeds, prior to operating equipment in the production environment at full speed in automatic mode.
- It is the customer's responsibility to verify all required motion sequences are correct, prior to operating equipment in the production environment at full speed in automatic mode.
- Switching the machinery into Auto mode without having verified the control interlocks and motion sequence are correct, may cause damage to machinery and / or equipment.

Failure to do wiring or connections properly will result in equipment failure.



3.6 Lockout Safety

WARNING

DO NOT enter the cabinet without first ISOLATING the supplies.

High voltage and amperage cables are connected to the controller and the mold. There is also a high voltage cable connection between the servo motor and the controller. Electrical power must be shut off and lockout / tagout procedures followed prior to installing or removing any cables.

Use lockout / tagout to prevent operation during maintenance.

All maintenance should be performed by properly trained personnel based on local laws and regulation. Electrical products may not be grounded when removed from the assembled or normal operating condition.

Ensure proper grounding of all electrical components before performing any maintenance to avoid potential risk of electrical shock.

Often power sources are inadvertently turned on or valves are opened mistakenly before maintenance work is completed, resulting in serious injuries and fatalities. Therefore, it is important to ensure that all energies are properly locked out and that they remain locked out until the work is completed.

If a lockout is not performed, uncontrolled energies could cause:

- Electrocutation from contact with live circuits
- Cuts, bruises, crushing, amputations or death, resulting from entanglement with belts, chains, conveyors, rollers, shafts, impellers
- Burns from contact with hot parts, materials or equipment such as furnaces
- Fires and explosions
- Chemical exposures from gases or liquids released from pipelines



3.7 Electrical Lockout

WARNING - READ MANUAL

Refer to all machine manuals and local regulations and codes.

NOTE

In some instances, there may be more than one power source feeding equipment and steps must be taken to ensure that all sources are effectively locked out.

Employers must provide an effective lockout / tagout program.

1. Shut down machine using normal operational shutdown procedure and controls. This should be done by, or in consultation with the machine operator.
2. After ensuring that the machinery has been completely shut down, and all controls in the “off” position, open the main disconnect switch located in the field.
3. Using your own personal padlock, or one assigned by your supervisor, lock the disconnect switch in the off position. Do not lock only the box. Remove the key and retain. Complete a lockout tag and affix to the disconnect switch. Each person working on the equipment must follow this step. The lock of the person doing the work or in charge must be installed first, remain throughout and be removed last. Test the main disconnect switch and make sure it cannot be moved to the “on” position.
4. Try to start the machine using the normal operation controls and point of operation switches to make sure that the power has been disconnected.
5. Other sources of energy that could create a hazard while working on the equipment must also be de-energized and appropriately “locked-out”. This can include gravity, compressed air, hydraulics, steam and other pressurized or hazardous liquids and gases. See Table 3-3.
6. When the work is completed, prior to removing the last lock, make sure the operational controls are in the “off” position so that the main disconnect switching is done under “no load”. Ensure all blocks, tools and other foreign materials are removed from machine. Also ensure that all personnel that may be affected are informed that the lock(s) will be removed.
7. Remove lock and tag, and close the main disconnect switch if permission has been given.
8. When the work has not been completed on the first shift, the next operator should install a personal lock and tag before the first operator removes the original lock and tag. If the next operator is delayed, a lock and tag could be installed by the next supervisor. Lockout procedures should indicate how the transfer is to be conducted.
9. It is important that, for their personal protection, each worker and/or foreperson working in or on a machine places his/her own safety lock on the disconnect switch. Use tags to spotlight work in progress and give details of work being done. Only when the work is completed and the work permit signed off, may each worker remove his/her lock. The last lock to be removed should be that of the person supervising the lockout and this responsibility should not be delegated.

© Industrial Accident Prevention Association, 2008.

3.7.1 Energy Forms and Lockout Guidelines

Table 3-3 Energy Forms, Energy Sources and General Lockout Guidelines		
Energy Form	Energy Source	Lockout Guidelines
Electrical Energy	<ul style="list-style-type: none"> • Power transmission lines • Machine power cords • Motors • Solenoids • Capacitors (stored electrical energy) 	<ul style="list-style-type: none"> • Turn off power at machine first (i.e., at point of operation switch), and then at the main disconnect switch for the machine. • Lock and tag the main disconnect switch. • Fully discharge all capacitive systems (e.g., cycle machine to drain power from capacitors) according to the manufacturer's instructions.
Hydraulic Energy	<ul style="list-style-type: none"> • Hydraulic systems (e.g., hydraulic presses, rams, cylinders, hammers) 	<ul style="list-style-type: none"> • Shut off, lock (with chains, built-in lockout devices, or lockout attachments) and tag valves. • Bleed off and blank lines as necessary.
Pneumatic Energy	<ul style="list-style-type: none"> • Pneumatic systems (e.g., lines, pressure reservoirs, accumulators, air surge tanks, rams, cylinders) 	<ul style="list-style-type: none"> • Shut off, lock (with chains, built-in lockout devices, or lockout attachments) and tag valves. • Bleed off excess air. • If pressure cannot be relieved, block any possible movement of machinery.
Kinetic Energy (Energy of a moving object or materials. Moving object may be powered or coasting)	<ul style="list-style-type: none"> • Blades • Flywheels • Materials in supply lines 	<ul style="list-style-type: none"> • Stop and block machine parts (e.g. stop flywheels and ensure that they do not recycle). • Review entire cycle of mechanical motion, ensure that all motions are stopped. • Block material from moving into area of work. • Blank as necessary.
Potential Energy (Stored energy that an object has the potential to release due to its position)	<ul style="list-style-type: none"> • Springs (e.g., in air brake cylinders) • Actuators • Counterweights • Raised loads • Top or movable part of a press or lifting device 	<ul style="list-style-type: none"> • If possible, lower all suspended parts and loads to the lowest (rest) position. • Block parts that might be moved by gravity. • Release or block spring energy.
Thermal Energy	<ul style="list-style-type: none"> • Supply lines • Storage tanks and vessels 	<ul style="list-style-type: none"> • Shut off, lock (with chains, built-in lockout devices, or lockout attachments) and tag valves. • Bleed off excess liquids or gases. • Blank lines as necessary.

3.8 Grounded Earth Connections - SVG

The SVG controller has a ground bar. See Figure 3-2.

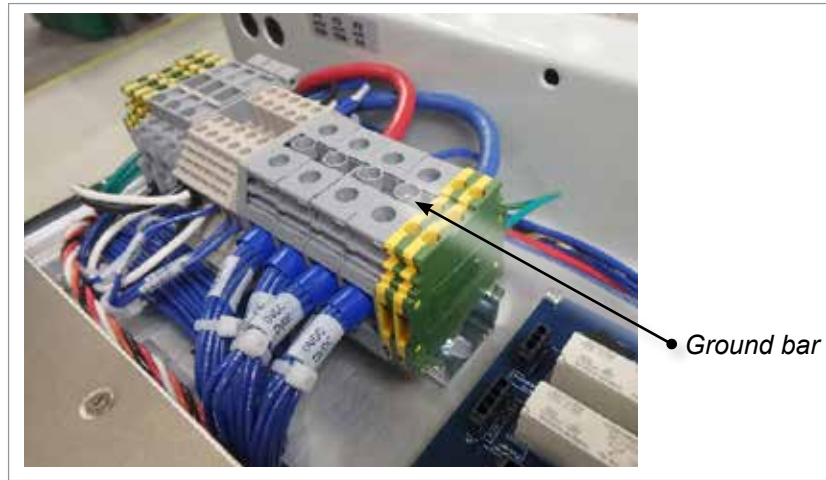

Figure 3-2 Ground bar in SVG controller

3.9 Grounded Earth Connections - Compact SVG

The grounded earth connection for the compact SVG is found behind the side panel, sealed with four screws.

3.10 Disposal



WARNING

Milacron *Mold-Masters* declines any responsibility for personal injury or personal damage arising from reuse of the individual components, if these parts are used other than for the original and proper intended purpose.

1. Hot runner and system components must be disconnected from the power supply fully and properly before disposal, including electricity, hydraulics, pneumatics and cooling.
2. Ensure that the system to be disposed of is free from fluids. In the case of hydraulic needle valve systems, drain the oil from the lines and cylinders and dispose it in an environmentally responsible manner.
3. The electrical components are to be dismantled, separating them accordingly as environmentally-friendly waste or disposed as hazardous waste if necessary.
4. Remove the wiring. The electronic components are to be disposed in accordance with the national electric scrap ordinance.
5. The metal parts are to be returned for metal recycling (waste metal and scrap trade). The instructions of the corresponding waste disposal company are to be observed in this case.

Recycling of the materials occupies a forefront position during the disposal process.



3.11 SVG/Compact SVG Controller User Hazards

WARNING - ELECTRIC SHOCK HAZARD

It is crucial to comply with these warnings to minimize any personal danger.

- Ensure that all energies are properly locked out in the controller and mold machine before installation of the controller into the system.
- DO NOT enter the cabinet without first ISOLATING the supplies. There are unguarded terminals inside the cabinet which may have a dangerous potential across them. Where a three-phase supply is used, this potential may be up to 600VAC.
- Voltage and amperage cables are connected to the controller and the mold. Electric power must be shut off and lockout / tagout procedures followed prior to installing or removing any cables.
- Integration should be done by properly trained personnel based on local codes and regulations. Electrical products may not be grounded when removed from the assembled or normal operating condition.
- Do not mix electrical power cables with thermocouple extension cables. They are not designed to carry the power load or list accurate temperature readings in each other's application.
- The main power switch is a 2-pole rocker switch. For the SVG controller, this switch is located at the rear of the cabinet. For the compact SVG controller, this switch is located at the front of the controller. These switches are rated to safely handle the total load current during switch on and switch off.
- Safe disconnection can only be achieved by disconnecting the unit from the mains supply socket.
- All maintenance should be performed by properly trained personnel based on local codes and regulation. Electrical products may not be grounded when removed from the assembled or normal operating condition.
- Ensure proper grounding of all electrical components before performing any maintenance to avoid potential risk of electrical shock.



3.11.1 Operational Environment

WARNING

The display console and controller cabinet together are designed for use in the plastic injection moulding industry as temperature controllers for third party hot runner systems as commonly used in mold tools. They must not be used in residential, commercial or light-industrial environments. Furthermore, they must not be used in an explosive atmosphere, or where there is a possibility of such an atmosphere developing.

The controller cabinet and touchscreen console should be installed in a clean dry environment where the ambient conditions do not exceed the following limits:

- Temperature +5 to +45°C
- Relative Humidity 90% (non-condensing)

Section 4 - Overview



NOTE

The SVG and compact SVG controllers both operate in the same way, but there are differences in some of their features.

This manual will use SVG to refer to both controllers, and it will specifically note if there is a difference between the two controllers.

4.1 Introduction

The SVG controllers (SVG) offer a means of controlling 24V output signals to control the sequence of valve gates that are used to distribute plastic evenly across a larger mold to avoid knit lines or similar visual defects.

The SVG controllers use 12-zone cards to switch a number of valve injection gates in a precise sequence that may relate to the main screw position or to a set time after it receives the start signal.

Each zone is individually configurable to open and close in response to:

- Time to the nearest 1/100th second from receiving a cycle-start signal.
- Position of the main barrel screw feed.
- A combination of the these two triggers.

4.1.1 SVG Controller

Each individual gate also has an optional provision to receive handshake, or feedback signals, to confirm that the valve is “Open” or “Closed” as commanded.

4.1.2 Compact SVG Controller

The controller has an integral console and accommodates one card to offer sequencing for up to 12 zones.

4.2 Screen Layout

4.2.1 Information

The bottom row shows overall information. Reading left to right this includes:

- the current operating mode
- a message bar, which can show password prompts and other information
- the current health status



4.2.2 Control

Side command buttons that change from page to page.



4.2.3 Navigation

The Main page has a **[Menu]** button at the bottom of the side buttons that activates the navigation screen.

All other pages use the **[Back]** button on the sidebar to return to the main page.



4.3 SVG Main Page – Display Options

For controllers with 10 or less active zones, the Main page will show fewer but larger panels. If there are more than 10 active zones, the Main page will show a 24 zone display that has smaller panels.



Figure 4-1 10 zone display



Figure 4-2 24 zone display

Choose **[Display]** to reveal a tabular view.

This view will show feedback from the handshake sensors, which confirm that a gate is open or closed.

It also offers a Manual control mode to open or close selected gates.

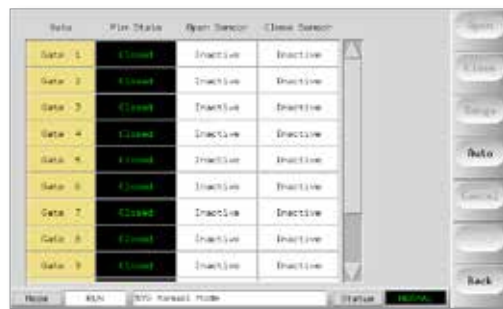

Figure 4-3 Tabular display

4.4 Compact SVG Main Screen – Display Options

For controllers with 10 or less active zones, the Main screen will show fewer but larger panels. If there are more than 10 active zones, the Main screen will show a 12 zone display that has smaller panels.



Figure 4-4 Display with 10 zones



Figure 4-5 Display with 12 zones

Choose **[Display]** to reveal a tabular view.

This view will show feedback from the handshake sensors, which confirm that a gate is open or closed.

It also offers a Manual control mode to open or close selected gates.

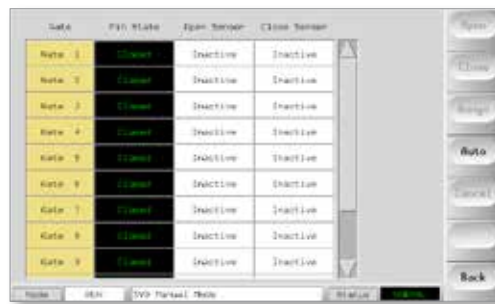

Figure 4-6 Tabular display

4.5 The User Interface

Where the configuration of parameters requires a user interface then either a keyboard or a keypad is displayed.

Keyboard - for alphanumeric input



Keypad – for basic numeric input



4.6 Screensaver

The screen light turns off the backlight after five minutes of inactivity. Touch the screen anywhere to restore light to the screen.

Section 5 - Setup



WARNING

Ensure that you have fully read “Section 3 - Safety” before connecting or operating the controller.

It is the responsibility of the integrator to understand and follow international and local standards for safety of machinery when integrating the controller with the molding system.

The SVG controller should be located in such a way that the main disconnect is easily accessible in case of emergency.

SVG controllers are shipped with a power cable, which is a correct size to run the system. When you install a connector on the cable, ensure that the connector can safely withstand the full system load.



WARNING - ELECTRIC SHOCK HAZARD

It is crucial to comply with these warnings to minimize any personal danger.

- There is no simple means of locking the switch so safety disconnection can only be achieved by disconnecting the unit from the mains supply socket.
- DO NOT enter the cabinet without first ISOLATING the supplies. There are unguarded terminals inside the cabinet which may have a dangerous potential across them. Where a three-phase supply is used, this potential may be up to 600VAC.
- Voltage and amperage cables are connected to the controller and the mold. Electric power must be shut off prior to installing or removing any cables.
- Integration should be done by properly trained personnel based on local codes and regulations. Electrical products may not be grounded when removed from the assembled or normal operating condition.
- Do not mix electrical power cables with thermocouple extension cables. They are not designed to carry the power load or list accurate temperature readings in each other's application.



WARNING - TRIP HAZARD

The integrator should ensure that the controller cables do not present a trip hazard on the floor between the controller and the mold machine.

SVG controllers are provisionally configured at the factory and no extra setup may be required. The Setup section can be used if the controller needs to work with a new tool or in a new environment.

5.1 Setup the Controller

New SVG controllers are provisionally configured at the factory and no extra setup may be required.

To integrate the controller with a new tool or new environment, use the following sections:

- “5.2 Create a First Tool” on page 5-3
- “5.3 Configure the Tool” on page 5-7
- “5.4 Configure System Settings” on page 5-7
- “5.5 Set the Inputs” on page 5-8
- “5.6 Set Open / Close Triggers” on page 5-12

5.2 Create a First Tool

1. Choose [Menu] and choose the Tool page.



2. Select a blank tool slot and choose [Detect]. If requested, enter the System password.

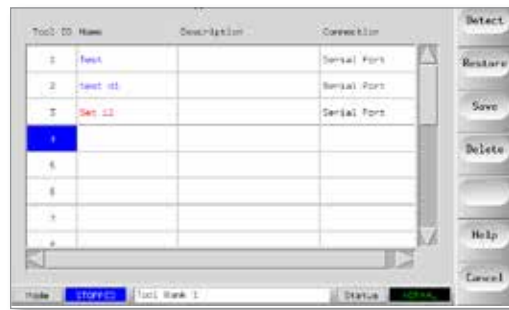

3. Type in a new name for the tool and choose [Enter].



The console runs an automatic “Card Detect” routine to identify the number of cards and their type. See Figure 5-1.



Figure 5-1 Card detect routine

Create a First Tool - continued



NOTE

If the system has any problem running the detect sequence, it may report “Auto Detect Failed” and ask if you want to repeat the Detect routine. If the reason for failure is obvious, such as a loose network cable or a mains glitch, then you may choose [OK] to retry card detection.

If the detection routine continues to fail, contact your supplier for advice.

For more information about the types of cards used in the SVG controllers, please see “Table 5-1 Cards - Setup”.

Table 5-1 Cards - Setup	
Symbol	Card and Description
	12-channel SVG card used for temperature monitoring using thermocouple sensors. The first channel shows the card symbol. Subsequent zones appear as numbered links.

Once the controller has gathered this information, the console opens the Setup page:

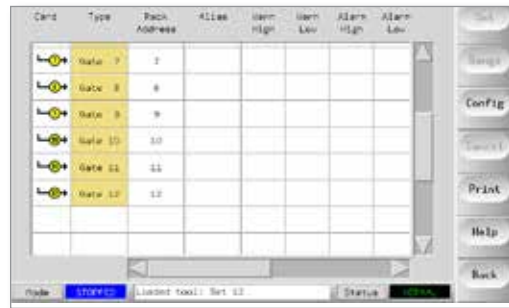

5.2.1 Configure Zone Types

The Setup grid displays an icon in the first column to show the detected card.

This is an example of an initial screen:



Any zones not in use can be set to **[Not Used]**.

1. Choose **[Menu]** and choose the Setup page.

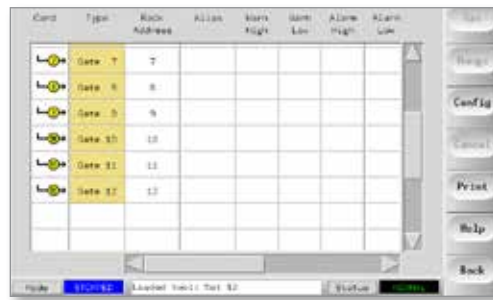

2. Choose the last two zones and choose **[Set]**.



3. Choose **[Not Used]** and **[OK]**.
The controller reconfigures these zones.



4. Choose **[Back]** to return to Main page.

Create a First Tool - How Many Channels - continued

As there are only 10 zones in this example, the screen shows the larger display:



5.3 Configure the Tool

Once the card information has been written into the Setup screen the user can determine how many of those zones are required for the initial tool.



NOTE

The Setup screen has many columns such as Alias, Warn and Alarm levels. Many of these are not applicable to the SVG card.

Return to the Setup screen to configure the tool.

1. Choose [**Config**] to see the Configure Controller panel.
2. Set the parameters.



Table 5-2 Tool Parameters	
Parameter	Description
Alarm Time	Short delay that holds off alarms in to ensure that short alarms do not raise false alarms
Max Cycle Time	User can vary the length of time the graph on the Preview screen is shown
Monitor Time Note: not applicable for the compact SVG	User can set a timeout value for handshake sensors to detect open or closed conditions If the condition does not change within this set time, an alarm is raised
Number of Steps	How often the gates need to open / close within a complete cycle 1 to 4 steps are available
Valve Type	Choice of single action or double action valves

5.4 Configure System Settings

The [**Config**] button opens the main valve gate parameters for the sequencer.

5.5 Set the Inputs

The user can set gate opening and gate closing times using two options:

1. **Time value only** – if there are no ancillary sensors then the only choice is to use an internal time to set gate open and close intervals.
2. **Screw Position (and time)** –if there are position sensors that detect screw ram position and feed it back via an analogue input then gate open and close timings can be set relative to screw position.



NOTE

It is also possible to use a combination of screw position and time, or a wider combination of position and time.

Open and close trigger options are shown in Table 5-3:

Table 5-3 Open and Close Trigger Options				
Screw Sensor	Open Variable		Close Variable	
None	Absolute time	Gates are opened: <ul style="list-style-type: none"> • at a fixed time after the start (Abs) 	Absolute time OR Incremental time	Gates are closed: <ul style="list-style-type: none"> • at a fixed time after the start (Abs) OR <ul style="list-style-type: none"> • at an incremental time (Inc) since the gate was opened
Available	Absolute time OR Screw position	Gates are opened: <ul style="list-style-type: none"> • at a fixed time after the start (Abs) OR <ul style="list-style-type: none"> • at a fixed screw position (Screw) 	Absolute time OR Incremental time OR Screw position	Gates are closed: <ul style="list-style-type: none"> • at a fixed time after the start (Abs) OR <ul style="list-style-type: none"> • at an incremental time since the gate was opened (Inc) OR <ul style="list-style-type: none"> • at a fixed screw position (Screw)

5.5.1 Set Screw Input

The position sensor must be fixed to the ram and its output must be connected to the injection molding machine socket to set screw input. See “9.3 External Wiring Connections” on page 9-2 for pin connections.

To setup screw sensor input, the user must

- a) Select screw sensor input
 - b) Calibrate screw sensor input
1. From the Main screen, choose [**Menu**] and choose [**Inputs**].



2. Choose [**Analog Input 1**] and then [**Set**].

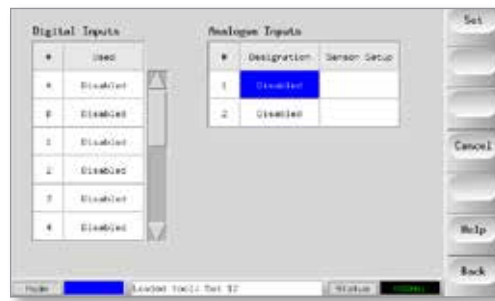

3. At the Configure Analog Input screen choose [**Screw**] and [**OK**].

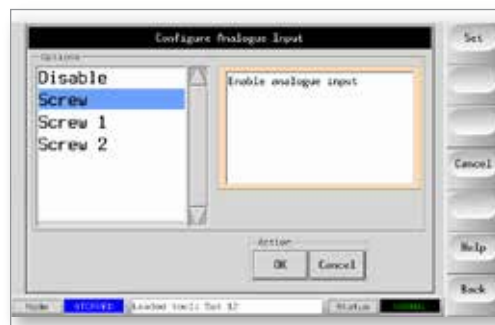

Set Screw Input - continued

The user is returned to the Input screen. Note that Analog Screw Input is now an option. See Figure 5-2.



Figure 5-2 Analog Screw Input now available

The actual screw position must now be calibrated.

4. At Analog Input 1, choose [**Setup**], and choose [**Set**].



The SVG Screw Calibration screen opens:



The user follows the seven steps shown on the screen to calibrate the controller to the actual screw position sensor.

5.5.2 Screw Calibration Steps

1. Choose **[Units]** and set the sensor to display as metric or imperial.



2. Choose **[Screw Length]** and type in the physical length of the screw ram travel.



3. Move screw to forward position.
4. Touch the **[Forward]** box.
5. Move screw to back position.
6. Touch the **[Back]** box.



NOTE

Any or all of steps 3 to 6 can be repeated if the readings are not accurate.

7. Choose **[OK]** when all measurements are satisfactory.
8. Choose **[Back]** to return to the Main screen to set the individual gate open and close sequence.

5.6 Set Open / Close Triggers

The user can set all open and close triggers at the same time.

1. Choose any zone and choose [Set].



2. Choose the opening Trigger type and choose all gates.



3. Choose any open trigger box and choose [Set].



4. Choose the opening parameter [Time or Screw] and choose [OK].



Setup the Open / Close Parameters - continued

5. Choose any Closing Trigger box and choose [Set].



6. Choose the closing parameter [Time or Screw] and choose [OK].



5.7 Set Gate Open / Close Values

The user must start at the first gate to set individual open and close values.



1. Choose Gate 1, choose the **[Open Value]** column and choose **[Set]**.
2. Set the open value and choose **[Ent]**.
3. Choose the **[Close Value]** column and choose **[Set]**.
4. Set the close value and choose **[Ent]**.



Figure 5-3 Enter open and close values for each gate

5. Repeat for all other gates.
6. Choose **[Preview]** to get an overview of the sequence.

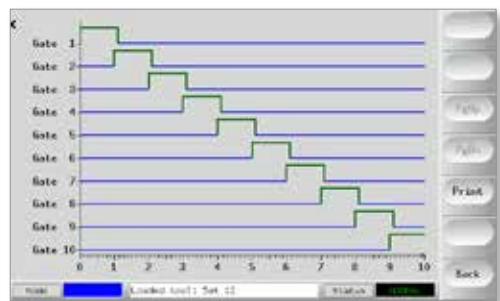

Figure 5-4 Preview screen



NOTE

The red line at the bottom shows when no gates are open, and it also helps to show if any gates are incorrectly set.

5.8 Other Utility Functions

The Utilities page offers various system settings that are not tool specific.

Table 5-4 Utility Functions	
Option	Setting
Software Version	Non user configurable – this reports the version of software current installed.
Time	Shows the actual time.
Date	Shows the actual date.
Language	This offers a selection of languages.
Blanking Delay	The screen stays illuminated while it is being used. This sets how long it remains illuminated before fading to black while it is idle. Setting to “99” keeps the screen permanently visible.
Baud Rate	This is currently set to the only option of 38400.
Console Startup	Selects whether the console goes into Run Enabled or Stopped mode when it is first switched on.
Printer	There are three print options: Soft e-print to a USB Memory card – you can set the format for screen prints. HARD Copy prints to a Local printer – you have a selection of printer types that may be connected to the console via the same USB socket. Hard copy to a network Printer – the same list of printer drivers is available for when network printers are connected via the LAN.
Printer Address	Set the IP Address for a remote printer if the Networked option is selected.
Paper Size	Choose A4 or Letter.
Machine Name	cm-t3530
Domain Name	
IP Address	A unique IP address that the console offers to a network to identify itself. This is not user configurable.
Net mask	
Obtain Address	Enable this option to allow the console to be automatically given a local identity via DHCP.
User Password	Permit basic operation with or without user password.
Edit User Password	Set your own User password (this needs an admin, or system, password to change this option).
Edit System Password	Set your own high level System password (this needs an admin, or system, password to change this option).
Password Timer	How long before a typed password remains operable until it needs to be retyped again.
Calibrate Touch	Recalibrate how the screen responds for rare occasions should touch-screen appear to respond incorrectly or inappropriately.

5.9 Setup Examples

Each valve gate can have up to four steps. The valve will act according to these step settings.



NOTE

A step = the number of times the gate must open and close in one complete cycle

Time (abs) = time absolute (time is relative to the start of cycle start input)

Time (inc) = time incremental (time is relative to the when the valve was opened)

5.9.1 Use Time Values Alone

Open the valve on an absolute time (relative to the start of the cycle) and close it on an absolute time value (relative to the start of the cycle).

Step 1 Open Trigger	Step 1 Open Value	Step 1 Close Trigger	Step 1 Close Value
Time (abs)	0.00 secs	Time (abs)	0.00 secs

Open the valve on an absolute time (relative to the start of cycle) and close it on an incremental time (relative to the when the valve was opened).

Step 1 Open Trigger	Step 1 Open Value	Step 1 Close Trigger	Step 1 Close Value
Time (abs)	0.00 secs	Time (inc)	1.25 secs

5.9.2 Screw Position Alone

Open the valve on screw position and close it on the screw position.

Step 1 Open Trigger	Step 1 Open Value	Step 1 Close Trigger	Step 1 Close Value
Screw	0 mm	Screw	0 mm

5.9.3 Use a Combination of Both Time and Position



NOTE

The two parameters move in opposite directions. A time trigger starts at zero and counts **up** as the screw closes. A screw position trigger starts at full length and counts **down** while the screw closes.

Open the valve on an absolute time (relative to the start of cycle) and close it on screw position.

Step 1 Open Trigger	Step 1 Open Value	Step 1 Close Trigger	Step 1 Close Value
Time (abs)	1.00 secs	Screw	0 mm

Open the valve on position of the screw and close it on an absolute time (relative to the start of cycle).

Step 1 Open Trigger	Step 1 Open Value	Step 1 Close Trigger	Step 1 Close Value
Screw	0 mm	Time (abs)	0.00 secs

Open the valve on screw position and close it on an incremental time (relative to the when the valve was opened).

Step 1 Open Trigger	Step 1 Open Value	Step 1 Close Trigger	Step 1 Close Value
Screw	0 mm	Time (inc)	0.00 secs

Section 6 - Operation



WARNING

Ensure that you have fully read “Section 3 - Safety” before operating the controller.

6.1 Main Screen



Figure 6-1 Main screen

6.2 Switch On / Switch Off



WARNING - HIGH VOLTAGE

Safe disconnection can only be achieved by disconnecting the unit from the mains supply socket.

6.2.1 SVG Controller

The main power switch is a 2-pole rocker switch at the rear of the cabinet. This switch is rated to safely handle the total load current during switch on and switch off. See Figure 6-2.



Figure 6-2 SVG controller main switch

6.2.2 Compact SVG Controller

The main switch is a 2-pole rocker located on the front of the cabinet. This switch is rated to safely handle the total load current during switch on and switch off. See Figure 6-3

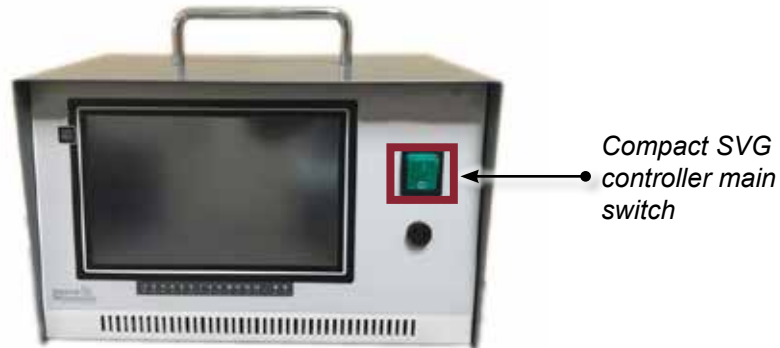

Figure 6-3 Compact SVG controller main switch

6.3 Run and Stop

1. Choose **[Run]** to put the controller into Standby mode, in which the controller is ready to respond to the external start trigger.

When the controller receives this external signal, it initiates the start / run timer from the zero time position, and the gates open and close according to the configured settings.

2. Choose **[Stop]** to stop the run sequence and close all gates.

Section 7 - Maintenance



WARNING

Ensure that you have fully read “Section 3 - Safety” before servicing or repairing the controller.



WARNING - HIGH VOLTAGE

Always isolate your controller at source before you open the unit to inspect it or replace fuses.



CAUTION

External cables should be checked to see that there has been no damage to the flexible conduit, plugs or sockets. If the flexible conduit has been damaged or if there are any exposed conductors, it must be replaced.

Any internal cable forms that flex to accommodate opening doors should be checked to see that there is no fraying or damage to cable insulation.

7.1 Replacement Parts

Mold-Masters does not expect that you will need to repair any controller parts at board level other than fuses. In the unlikely event of any board failure then we provide an excellent repair and exchange facility for all our customers.

7.2 Equipment Inspection

If the equipment is subject to vibration then we recommend that you use an insulated screwdriver to check that no terminals have become loose.

External cable-looms should be checked to see that there has been no damage to the flexible conduit, plugs or sockets. If the flex has been squashed, if there is visible damage, or if there are any exposed conductors, then, for your own safety, it must be replaced.

7.3 Fuses



WARNING - HIGH VOLTAGE

Always isolate your controller at source before you open the unit to inspect it or replace fuses.

7.3.1 Supplementary Fuse - SVG

The console supply, power supply and the feed to the HAN16 injection mold machine connector are protected by a single fuse. It can be found on the front of the controller, behind a panel accessed by four retaining screws.

Table 7-1 Supplementary Fuse	
Fuse	1 fuse
Class	250 V ceramic slowblow
Rating	5 A

7.3.2 Controller Card Fuses - SVG

The controller cards have one fused supply for every channel. These fuses are mounted on the board and detailed in the table below.

The card can slide out from the rack after you remove the top and side cover. Undo the four retaining screws at the rear.

Table 7-2 Controller Card Fuses	
Fuse	12 channel onboard fuses
Class	20mm Glass Fuse Anti-surge
Rating	2 A

7.3.3 Controller Card Fuse - Compact SVG

The fuse holders are located at the rear of the controller.

1. Remove the four screws from the cover plate at the back of the controller. See Figure 7-1.

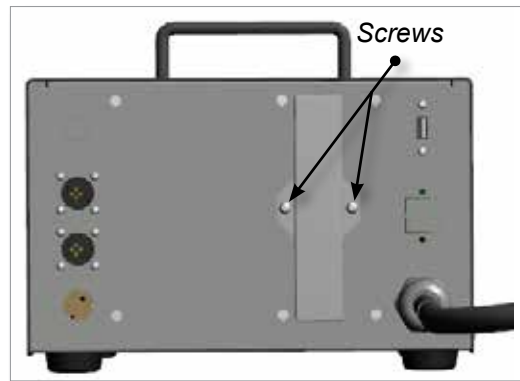

Figure 7-1 Remove screws

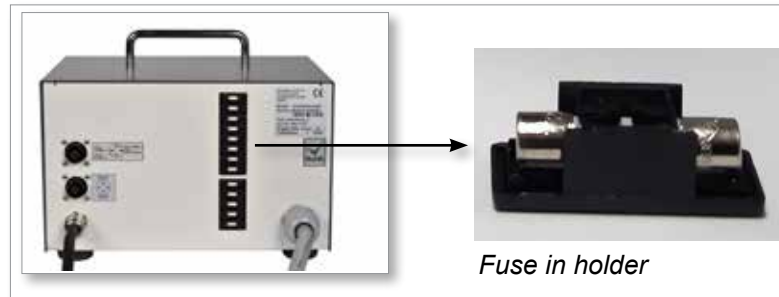

Figure 7-2 Fuse bank - compact SVG controller

2. Pull the fuse holder out by hand. See Figure 7-2.
3. Remove and replace the fuse.

Table 7-3 Controller Card Fuse	
Fuse	1 fuse
Class	250 V ceramic slowblow
Rating	2 Amp

Section 8 - Troubleshooting



WARNING

Ensure that you have fully read “Section 3 - Safety” before troubleshooting any issues with the controller.



WARNING - HIGH VOLTAGE

The fuse detection circuit requires a continuous low level current through a high impedance bleed resistor to maintain the alarm condition.

As a result the load circuit is still connected to the mains voltage supply and it is not safe to attempt to repair or replace the fuse without first isolating the circuit.

8.1 Fault and Warning Messages

Any of the following messages may be displayed on the Fault Indication line:

Table 8-1 Troubleshooting		
Error Message	Cause	Action
FUSE	The fuse for that zone has failed. Note: a fuse can only fail due to a fault external to the controller. Identify and rectify the fault before replacing the fuse.	Replace the fuse with one of the same rating and type.
HELP	There is a system failure and the console does not know how to respond.	Please make a note of the serial number and also note the console software date on the Utilities page. Contact your supplier with this information to hand.
N/Z	All the control cards are interrogated in sequence, on a working controller you can see the SCAN LEDs flashing in a sequence as each card is briefly checked for satisfactory communication. If any card fails to respond to the console then an N/Z error message is displayed for the offending zone.	If every zone shows N/Z and no cards show or flash their SCAN LEDs then check the communication lead between the console and the controller cabinet.
If the SVG is fitted with option Handshake inputs then it can generate alarm if an “Open” or “Close” command is not confirmed by auxiliary contacts.		
PINO / PINC	An open or close signal has not been confirmed by the feedback circuit so PINOpen or PINClosed is indicated.	Switch the unit to manual and check to see if the gate actuator and the position sensors are functioning correctly. Check external wiring for disconnects or open circuits.

Section 9 - Hot Runner Controller Wiring Details



WARNING

Ensure that you have fully read “Section 3 - Safety” before connecting the controller.



WARNING - HIGH VOLTAGE

Please take extreme care when connecting the controller.

Do not change the supply wiring until the controller has been disconnected from all electrical supplies.

The following standards only apply to controllers wired to *Mold-Masters* standard. Other specifications may have been stated when the controller was ordered. Please refer to the supplied specification details.

9.1 Outputs

There is one HAN24E female connector for the twelve zones. The diagram below shows a typical connection diagram for an SVG-12. For each pair the higher numbered pin is at ground the lowered numbered side will energise at 24V DC when the controller calls for that valve to open.

9.2 Output Rating

Each output is rated at 5A 24V DC.

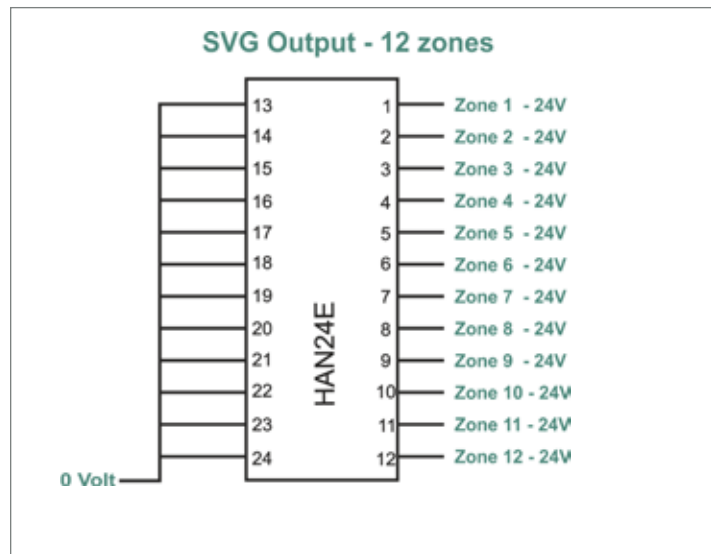

9.3 External Wiring Connections

9.3.1 Inputs - North American Version

Connector 1:

AMP04 Connector Number 1

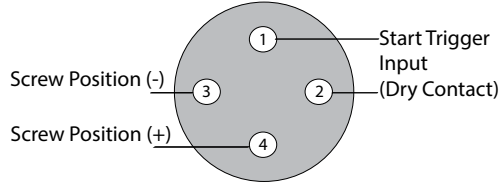

Figure 9-1 AMP04 connector number 1

Table 9-1 Connector 1 Inputs			
Circuit	Pins	Description	Format
Screw Position	3 and 4	Accepts a voltage source input that relates to the main screw position. A calibration routine within the controller adjusts actual input to actual screw position.	0 to 10 Volts
Start Trigger	1 and 2	Sees a closed condition as a signal to start the timer on the valve sequence.	Normally open pair

Connector 2:

AMP04 Connector Number 2

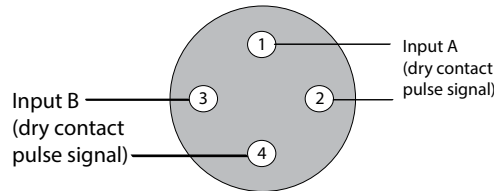

Figure 9-2 AMP04 connector number 2

Table 9-2 Connector 2 Inputs			
Circuit	Pins	Description	Format
Input A	1 and 2	Accepts a closing signal that can be used as a trigger for one or more gates.	Normally open pair (dry contact)
Input B	3 and 4	Accepts a closing signal that can be used as a trigger for one or more gates.	Normally open pair (dry contact)

9.3.2 Inputs - European Version



IMPORTANT

This section **does not** apply to the compact SVG controller.

A HAN16 connector provides interconnection for the control inputs as detailed below:

Table 9-3 HAN16 Connector Inputs			
Circuit	Pins	Description	Format
Alarm Output	5 & 13	Goes to “closed” when an alarm condition is generated.	Normally open pair
Analogue Input 1	6+ & 14 -	Accepts a current source input that relates to a main screw position. A calibration routine within the controller adjusts actual input to actual screw position.	4 to 20 mA
Analogue Input 2	7+ & 15-	Accepts a voltage source input that relates to the main screw position. A calibration routine within the controller adjusts actual input to actual screw position.	0 to 10 volts
Analogue Input 3	8+ & 16-	Accepts a voltage source input that relates to the secondary screw position. A calibration routine within the controller adjusts actual input to actual screw position.	0 to 10 volts
Start Trigger	1 & 9	Sees a closed condition as a signal to start the timer on the valve sequence	Normally open pair
Trigger A	2 & 10	Sees a closed condition as a ‘pulse’ signal to start the timer on the valve sequence.	Digital Input A
Trigger B	3 & 11	Sees a closed condition as a ‘pulse’ signal to start the timer on the valve sequence.	Digital Input B
Enable	4 & 12	Sees a closed condition as a signal that the injection machine is ready to start working. Any other signals present are ignored until the [Enable] is present	Normally open pair

9.4 Handshake Inputs (Optional)



IMPORTANT

This section **does not** apply to the compact SVG controller.

The SVG controller has the ability to use handshake or feedback inputs from sensors in the actuator that tell whether the valve is Open or Closed. There is no standard for this optional feature however the SVG cabinet has space for a HAN24B-sized connector so a high density connector such as the HAN72D would be fitted on request in order to accept feedback signals.

Index

A

Alarm Time 5-7

C

Configure the Tool 5-7

Create a First Tool 5-3

D

Display Options 4-3, 4-4

E

Electrical Testing 6-1

F

Fuses 7-1

O

Output Rating 9-1

S

Safety

Lockout 3-10

Safety Symbols

General Descriptions 3-8

Screen Layout 4-2

Screen Layout and Navigation 4-2

Setting a Screw Input 5-9

Setting the Inputs 5-8

T

Troubleshooting 8-1

U

User Interface 4-5



NORTH AMERICA

CANADA (Global HQ)

tel: +1 905 877 0185
e: canada@moldmasters.com

SOUTH AMERICA

BRAZIL (Regional HQ)

tel: +55 19 3518 4040
e: brazil@moldmasters.com

EUROPE

GERMANY (Regional HQ)

tel: +49 7221 50990
e: germany@moldmasters.com

SPAIN

tel: +34 93 575 41 29
e: spain@moldmasters.com

FRANCE

tel: +33 (0)1 78 05 40 20
e: france@moldmasters.com

ASIA / INDIA

CHINA (Regional HQ)

tel: +86 512 86162882
e: china@moldmasters.com

JAPAN

tel: +81 44 986 2101
e: japan@moldmasters.com

U.S.A.

tel: +1 248 544 5710
e: usa@moldmasters.com

MEXICO

tel: +52 442 713 5661 (sales)
e: mexico@moldmasters.com

UNITED KINGDOM

tel: +44 1432 265768
e: uk@moldmasters.com

POLAND

tel: +48 669 180 888 (sales)
e: poland@moldmasters.com

TURKEY

Tel: +90 216 577 32 44
e: turkey@moldmasters.com

KOREA

tel: +82 31 278 4757
e: korea@moldmasters.com

INDIA

tel: +91 422 423 4888
e: india@moldmasters.com

AUSTRIA

tel: +43 7582 51877
e: austria@moldmasters.com

CZECH REPUBLIC

tel: +420 571 619 017
e: czech@moldmasters.com

ITALY

tel: +39 049 501 99 55
e: italy@moldmasters.com

SINGAPORE

tel: +65 6261 7793
e: singapore@moldmasters.com