

E-Multi®

Controller User Manual

version 3-3



Contents

Section 1 - Introduction	1-1
1.1 Intended Use	1-1
1.2 Release Details	1-1
1.3 Warranty	1-1
1.4 Returned Goods Policy.....	1-1
1.5 Movement or Resale of Mold-Masters Products or Systems	1-1
1.6 Copyright	1-2
1.7 Units of Measure and Conversion Factors	1-2
 Section 2 - Global Support	 2-1
2.1 Corporate Offices.....	2-1
2.2 International Representatives.....	2-2
 Section 3 - Safety.....	 3-1
3.1 Introduction	3-1
3.2 Safety Hazards	3-2
3.3 Operational Hazards.....	3-5
3.4 General Safety Symbols.....	3-7
3.5 Wiring Check	3-8
3.6 Lockout Safety.....	3-9
3.6.1 Electrical Lockout.....	3-10
3.6.2 Energy Forms and Lockout Guidelines.....	3-11
3.7 Grounded Earth Connections	3-12
3.8 Disposal.....	3-12
3.9 E-Multi Controller Safety Hazards	3-13
3.9.1 Operational Environment.....	3-13
3.9.2 Cabinet Push / Tip Forces	3-13
3.10 E-Multi Injection Unit Safety Labels.....	3-15
3.11 E-Multi Injection Unit Safety Hazards	3-16
3.12 E-Multi Injection Unit Safety Symbols.....	3-18
3.13 E-Multi Injection Unit Safety Guards.....	3-19
3.14 E-Multi Weight Specifications	3-20
3.15 Unpack the E-Multi Controller.....	3-21
3.16 Lift the E-Multi Controller	3-23
3.16.1 Preparation	3-23
3.17 Lift the E-Multi Injection Unit.....	3-25
3.17.1 Prior to Lifting the E-Multi Injection Unit.....	3-25
3.18 EM1 / EM2 / EM3 Lift Connections.....	3-26
3.18.1 EM1 / EM2 / EM3 Vertical Lift Connections	3-26
3.18.2 EM1 / EM2 / EM3 Horizontal Lift Connections.....	3-27
3.19 E-Multi Injection Unit Stand Safety	3-28
 Section 4 - Overview	 4-1
4.1 Controller Front.....	4-1
4.2 Controller Back - Connections Side.....	4-2
4.3 Cable Holders.....	4-3

Section 5 - Installation	5-1
5.1 Introduction	5-1
5.2 Connect the Controller to the E-Multi	5-2
5.3 Connect a Robot to the Controller	5-2
5.4 Connect the Controller to the Molding Machine	5-3
5.5 Connect a Handheld HMI (Optional)	5-4
5.6 Connect Diagnostic Computer (Optional)	5-4
Section 6 - Operation	6-1
6.1 Introduction	6-1
6.2 Isolate the Controller	6-1
6.3 Switch On	6-2
6.4 Switch Off (Shutdown)	6-2
6.4.1 Shutdown the Heating	6-2
6.4.2 Shutdown the Controller	6-2
Section 7 - E-Multi Controller HMI Interface.....	7-1
7.1 Introduction	7-1
7.2 Cabinet Mounted Control Buttons	7-2
7.3 E-Multi Touchscreen Interface	7-3
7.3.1 Top Bar - Status Display	7-4
7.3.2 Active Movement Icons	7-5
7.3.3 Status Icons	7-5
7.3.4 Bottom Bar - Screen Navigation Buttons	7-6
7.3.5 Print Functionality	7-7
7.4 Screen Descriptions	7-8
7.5 Overview Screen	7-9
7.6 Injection Settings Screen	7-13
7.7 Hold Settings Screen	7-16
7.8 Recovery Settings Screen	7-18
7.9 Barrel Temperature Settings - Legacy Controllers*	7-21
7.10 Barrel Temperature Settings - Mold-Masters Screen	7-23
7.10.1 EM5 Barrel	7-26
7.11 Integrated Hot Runner Temperature Control (Option)	7-27
7.11.1 Monitor Screen	7-28
7.11.2 Setup Screen (Supervisor Level)	7-32
7.11.3 Utilities Screen (Supervisor Level)	7-36
7.12 Integrated E-Drive Control (Option)	7-38
7.12.1 E-Drive Control Buttons	7-39
7.13 Overview Screen	7-40
7.13.1 Homing	7-41
7.14 Settings Screen (Supervisor Level)	7-42
7.15 Valve Gate Settings Screen	7-44
7.16 Shutoff-Nozzle Settings Screen	7-46
7.17 Shutoff-Nozzle Settings Screen—Kortec	7-49
7.18 Production Graph Screen	7-52
7.18.1 Lower Menu Buttons	7-54
7.19 Software Oscilloscope	7-55
7.19.1 Measure Parameter	7-55

- 7.19.2 Trigger..... 7-56
- 7.19.3 Parameter 7-56
- 7.19.4 Line Color 7-57
- 7.20 Process Data (PD) Protocol Screen 7-58
 - 7.20.1 Lower Menu Buttons..... 7-59
- 7.21 Main Settings Screen 7-60
- 7.22 System Settings Screen 7-62
 - 7.22.1 Lower Menu Buttons..... 7-64
- 7.23 E-Multi Radial / Servo Carriage Screen..... 7-65
- 7.24 Auto Purge Screen 7-67
- 7.25 Info-Log Screen 7-69
- 7.26 Programmable I/O 7-71
 - 7.26.1 I/O Monitor Screen..... 7-73
- 7.27 Production Settings Screen 7-74
- 7.28 Drive Monitor Screen..... 7-75
- 7.29 Task Monitor Screen..... 7-77
- 7.30 Drive Parameter Monitor Screen 7-78
- 7.31 PID Settings..... 7-79
- 7.32 Reference Settings Screen..... 7-80
 - 7.32.1 Reference Settings Screen - continued 7-81
- 7.33 Machine Data Screen 7-82
- 7.34 Variable Monitor Screen 7-83
- 7.35 Delay Settings Screen 7-85
- 7.36 Calibration Settings Screens 7-86
- 7.37 Alarms Screen 7-87
- 7.38 Mold Data Screen..... 7-89
 - 7.38.1 Lower Menu Buttons..... 7-90
- 7.39 Euromap E67 Screen 7-91
- 7.40 Legacy E67 Screen 7-94

Section 8 - Preventive Maintenance8-1

- 8.1 Settings Tab (Configuring Tasks)..... 8-1
 - 8.1.1 Tasks..... 8-2
 - 8.1.2 Task Accessibility 8-2
 - 8.1.3 Task Names 8-3
 - 8.1.4 Disabled Tasks..... 8-3
 - 8.1.5 Enabled Supervisor Tasks 8-4
 - 8.1.6 Cycle Count Triggers 8-5
 - 8.1.7 Trigger Selection for Cycle Counting 8-7
 - 8.1.8 Messages 8-9
 - 8.1.9 Milacron User Level Tasks..... 8-10
 - 8.1.10 View Milacron Active Tasks..... 8-11
 - 8.1.11 Color Codes of Active Tasks 8-12
 - 8.1.12 Acknowledge a Task Has Been Performed..... 8-13
- 8.2 Reporting and Log View 8-14
 - 8.2.1 View the preventive maintenance history 8-14

Section 9 - Maintenance	9-1
9.1 Clean the HMI Screen	9-1
9.2 Preventive Maintenance	9-1
9.3 Put the Servo Carriage in the Maintenance Position.....	9-2
9.4 Verify Injection Pressure Oil Circuit (Preload Pressure).....	9-3
9.4.1 Check the Preload Oil Pressure	9-3
9.5 Nozzle Protrusion Adjustment - Automatic Adjustment.....	9-4
9.5.1 Carriage Home Position Calibration	9-4
9.5.2 Manual Calibration.....	9-4
9.5.3 Automatic Calibration.....	9-5
9.6 Injection Axis Referencing	9-6
9.7 Service and Repair The Controller	9-7
9.7.1 Replacement Parts	9-7
9.7.2 Cleaning and Inspection	9-7
9.8 Update Software.....	9-8
9.8.1 Save Mold Data	9-8
9.8.2 Save Machine Data	9-9
9.8.3 Install New Software.....	9-10
 Section 10 - Troubleshooting	 9-1
10.1 Thermocouple Electrical Check.....	9-1
10.2 Heater Continuity Check.....	9-1
10.3 Transducer Output Check.....	9-1
10.4 Vibrator Valve Check	9-1
10.5 Servo Motor Temperature Check.....	9-2
10.6 Troubleshoot the Control System	9-2
10.6.1 Fault and Warning Messages	9-3
10.7 Back Feed Protection (Injection Pawl) (optional).....	9-5
10.7.1 Injection Pawl Alarms.....	9-5
10.7.2 Entering setup mode.....	9-6
10.7.3 Removing an interlock	9-6
 Appendix A	 A-01
 Index	 I

Section 1 - Introduction

The purpose of this manual is to assist users in the integration, operation and maintenance of the E-Multi controller. This manual is designed to cover most system configurations. If you need additional information specific to your system please contact your representative or a *Mold-Masters* office whose location can be found in the “Global Support” section.

1.1 Intended Use

The E-Multi controller is an electrical switching device designed for use with the E-Multi Auxiliary Injection Unit (AIU). It is designed to be safe during normal operation. Any other uses would fall outside the engineered intent of this machine which may be a safety hazard and would void any and all warranties.

This manual is written for use by skilled persons who are familiar with injection molding machinery and their terminology. Operators should be familiar with plastic injection molding machines and the controls of such equipment. Maintenance persons should have sufficient understanding of electrical safety to appreciate the dangers of 3-phase supplies. They should know how to take appropriate measures to avoid any danger from electrical supplies.

1.2 Release Details

Document Number	Release Date	Version
AIU-UM-EN-01-02-11	May 2019	02-11
AIU-UM-EN-01-03	August 2020	03
EM--UM--ENG--01--03-2	October 2022	03-2
UM--EM--ENG--C--03-3	February 2023	03-3

1.3 Warranty

For current warranty information please refer to the documents available from our website: <https://www.moldmasters.com/support/warranty> or contact your *Mold-Masters* representative.

1.4 Returned Goods Policy

Please do not return any parts to *Mold-Masters* without pre-authorization and a return authorization number supplied by *Mold-Masters*.

Our policy is one of continuous improvement and we reserve the right to alter product specifications at any time without giving notice.

1.5 Movement or Resale of Mold-Masters Products or Systems

This documentation is intended for use in the country of destination for which the product or system was purchased.

Mold-Masters takes no responsibility for documentation of products or systems if they are relocated or resold outside the intended country of

destination, as stated on the accompanying invoice and/or waybill.

1.6 Copyright

© 2022 Mold-Masters (2007) Limited. All Rights Reserved. *Mold-Masters*® and the *Mold-Masters* logo are trademarks of Mold-Masters.

1.7 Units of Measure and Conversion Factors



NOTE

The dimensions given in this manual are from original manufacturing drawings.

All values in this manual are in S.I. units or subdivisions of these units. Imperial units are given in parenthesis immediately after the S.I. units.

Table 1-2 Units of Measure and Conversion Factors		
Abbreviation	Unit	Conversion Value
bar	Bar	14.5 psi
in.	Inch	25.4 mm
kg	Kilogram	2.205 lb
kPa	Kilopascal	0.145 psi
gal	Gallon	3.785 l
lb	Pound	0.4536 kg
lbf	Pound force	4.448 N
lbf.in.	Pound force inch	0.113 Nm
l	Litre	0.264 gallon
min	Minute	
mm	Millimeter	0.03937 in.
mΩ	Milli Ohm	
N	Newton	0.2248 lbf
Nm	Newton Meter	8.851 lbf.in.
psi	Pound per square inch	0.069 bar
psi	Pound per square inch	6.895 kPa
rpm	Revolutions per minute	
s	Second	
°	Degree	
°C	Degree Celsius	0.556 (°F -32)
°F	Degree Fahrenheit	1.8 °C +32

Section 2 - Global Support

2.1 Corporate Offices

GLOBAL HEADQUARTERS

CANADA

Mold-Masters (2007) Limited
233 Armstrong Avenue
Georgetown, Ontario
Canada L7G 4X5
tel: +1 905 877 0185
fax: +1 905 877 6979
canada@moldmasters.com

SOUTH AMERICAN HEADQUARTERS

BRAZIL

Mold-Masters do Brasil Ltda.
R. James Clerk Maxwell,
280 – Techno Park, Campinas
São Paulo, Brazil, 13069-380
tel: +55 19 3518 4040
brazil@moldmasters.com

UNITED KINGDOM & IRELAND

Mold-Masters (UK) Ltd Netherwood
Road
Rotherwas Ind. Est.
Hereford, HR2 6JU
United Kingdom
tel: +44 1432 265768
fax: +44 1432 263782
uk@moldmasters.com

AUSTRIA / EAST & SOUTHEAST EUROPE

Mold-Masters Handelsges.m.b.H.
Pyhrnstrasse 16
A-4553 Schlierbach
Austria
tel: +43 7582 51877
fax: +43 7582 51877 18
austria@moldmasters.com

ITALY

Mold-Masters Italia
Via Germania, 23
35010 Vigonza (PD)
Italy
tel: +39 049/5019955
fax: +39 049/5019951
italy@moldmasters.com

EUROPEAN HEADQUARTERS

GERMANY / SWITZERLAND

Mold-Masters Europa GmbH
Neumattring 1
76532 Baden-Baden, Germany
tel: +49 7221 50990
fax: +49 7221 53093
germany@moldmasters.com

INDIAN HEADQUARTERS

INDIA

Milacron India PVT Ltd. (Mold-
Masters Div.)
3B, Gandhiji Salai,
Nallampalayam, Rathinapuri
Post, Coimbatore T.N. 641027
tel: +91 422 423 4888
fax: +91 422 423 4800
india@moldmasters.com

USA

Mold-Masters Injectioneering
LLC, 29111 Stephenson
Highway, Madison Heights, MI
48071, USA
tel: +1 800 450 2270 (USA
only) tel: +1 (248) 544-5710
fax: +1 (248) 544-5712
usa@moldmasters.com

CZECH REPUBLIC

Mold-Masters Europa GmbH
Hlavni 823
75654 Zubri
Czech Republic
tel: +420 571 619 017
fax: +420 571 619 018
czech@moldmasters.com

KOREA

Mold-Masters Korea Ltd. E
dong, 2nd floor, 2625-6,
Jeongwang-dong, Siheung
City, Gyeonggi-do, 15117,
South Korea
tel: +82-31-431-4756
korea@moldmasters.com

ASIAN HEADQUARTERS

CHINA/HONG KONG/TAIWAN

Mold-Masters (KunShan) Co, Ltd
Zhao Tian Rd
Lu Jia Town, KunShan City
Jiang Su Province
People's Republic of China
tel: +86 512 86162882
fax: +86 512-86162883
china@moldmasters.com

JAPAN

Mold-Masters K.K.
1-4-17 Kurikidai, Asaoku Kawasaki,
Kanagawa
Japan, 215-0032
tel: +81 44 986 2101
fax: +81 44 986 3145
japan@moldmasters.com

FRANCE

Mold-Masters France
ZI la Marinière,
2 Rue Bernard Palissy
91070 Bondoufle, France
tel: +33 (0) 1 78 05 40 20
fax: +33 (0) 1 78 05 40 30
france@moldmasters.com

MEXICO

Milacron Mexico Plastics Services
S.A. de C.V.
Circuito El Marques norte #55
Parque Industrial El Marques
El Marques, Queretaro C.P. 76246
Mexico
tel: +52 442 713 5661 (sales)
tel: +52 442 713 5664 (service)
mexico@moldmasters.com

Corporate Offices - continued

SINGAPORE*

Mold-Masters Singapore PTE. Ltd.
No 48 Toh Guan Road East
#06-140 Enterprise Hub
Singapore 608586
Republic of Singapore
tel: +65 6261 7793
fax: +65 6261 8378
singapore@moldmasters.com
*Coverage includes Southeast
Asia, Australia, and New Zealand

SPAIN

Mold-Masters Europa GmbH
C/ Tecnología, 17
Edificio Canadá PL. 0 Office A2
08840 – Viladecans
Barcelona
tel: +34 93 575 41 29
e: spain@moldmasters.com

TURKEY

Mold-Masters Europa GmbH
Merkezi Almanya Türkiye
İstanbul Şubesi
Alanaldı Caddesi Bahçelerarası
Sokak No: 31/1
34736 İçerenköy-Ataşehir
İstanbul, Turkey
tel: +90 216 577 32 44
fax: +90 216 577 32 45
turkey@moldmasters.com

2.2 International Representatives

Argentina

Sollwert S.R.L.
La Pampa 2849 2^o B
C1428EAY Buenos Aires
Argentina
tel: +54 11 4786 5978
fax: +54 11 4786 5978 Ext.
35 sollwert@fibertel.com.ar

Belarus

HP Promcomplect
Sharangovicha 13
220018 Minsk
tel: +375 29 683-48-99
fax: +375 17 397-05-65
e: info@mold.by

Bulgaria

Mold-Trade OOD
62, Aleksandrovska
St. Ruse City
Bulgaria
tel: +359 82 821 054
fax: +359 82 821 054
contact@mold-trade.com

Denmark*

Englmayer A/S
Dam Holme 14-16
DK – 3660 Stenløse
Denmark tel: +45 46 733847
fax: +45 46 733859
support@englmayer.dk
*Coverage includes Norway
and Sweden

Finland**

Oy Scalar Ltd.
Tehtaankatu
10 11120 Riihimäki
Finland
tel: +358 10 387 2955
fax: +358 10 387 2950
info@scalar.fi
**Coverage includes Estonia

Greece

Ionian Chemicals S.A.
21 Pentelis Ave.
15235 Vrilissia, Athens
Greece
tel: +30 210 6836918-9
fax: +30 210 6828881
m.pavlou@ionianchemicals.gr

Israel

ASAF Industries Ltd. 29 Habanai
Street
PO Box 5598 Holon 58154 Israel
tel: +972 3 5581290
fax: +972 3 5581293
sales@asaf.com

Portugal

Gecim LDA
Rua Fonte Dos Ingleses, No 2
Engenho
2430-130 Marinha Grande
Portugal
tel: +351 244 575600
fax: +351 244 575601
gecim@gecim.pt

Romania

Tehnic Mold Trade SRL
Str. W. A Mozart nr. 17 Sect. 2
020251 Bucharesti
Romania
tel: +4 021 230 60 51
fax : +4 021 231 05 86
contact@matritehightech.ro

Russia

System LLC
Prkt Marshala Zhukova 4
123308 Moscow
Russia
tel: +7 (495) 199-14-51
moldmasters@system.com.ru

Slovenia

RD PICTA tehnologije d.o.o.
Žolgarjeva ulica 2
2310 Slovenska Bistrica
Slovenija
+386 59 969 117
info@picta.si

Ukraine

Company Park LLC
Gaydamatska str., 3, office 116
Kemenskoe City Dnipropetrovsk
Region 51935, Ukraine
tel: +38 (038) 277-82-82
moldmasters@parkgroup.com.ua

Section 3 - Safety

3.1 Introduction

Please be aware that the safety information provided by *Mold-Masters* does not absolve the integrator and employer from understanding and following international and local standards for safety of machinery. It is the responsibility of the end integrator to integrate the final system, provide necessary e-stop connections, safety interlocks and guarding, to choose the appropriate electrical cable for the region of use and to ensure compliance with all relevant standards.

It is the responsibility of the employer to:

- Properly train and instruct its personnel in the safe operation of equipment, including the use of all the safety devices.
- Provide its personnel with all necessary protective clothing, including such items as a face shield and heat resistant gloves.
- Ensure the original and continuing competence of personnel caring for, setting up, inspecting and maintaining injection molding equipment.
- Establish and follow a program of periodic and regular inspections of injection molding equipment to ensure it is in safe operating condition and proper adjustment.
- Ensure that no modifications, repairs or rebuild of portions are made to the equipment that reduces the level of safety existing at time of manufacture or remanufacture.

3.2 Safety Hazards



WARNING

Also refer to all machine manuals and local regulations and codes for safety information.

The following safety hazards are most commonly associated with injection molding equipment. See European Standard EN201 or American Standard ANSI/SPI B151.1.

Refer to the illustration of hazard areas below when reading the Safety Hazards Figure 3-1 on page 3-2.

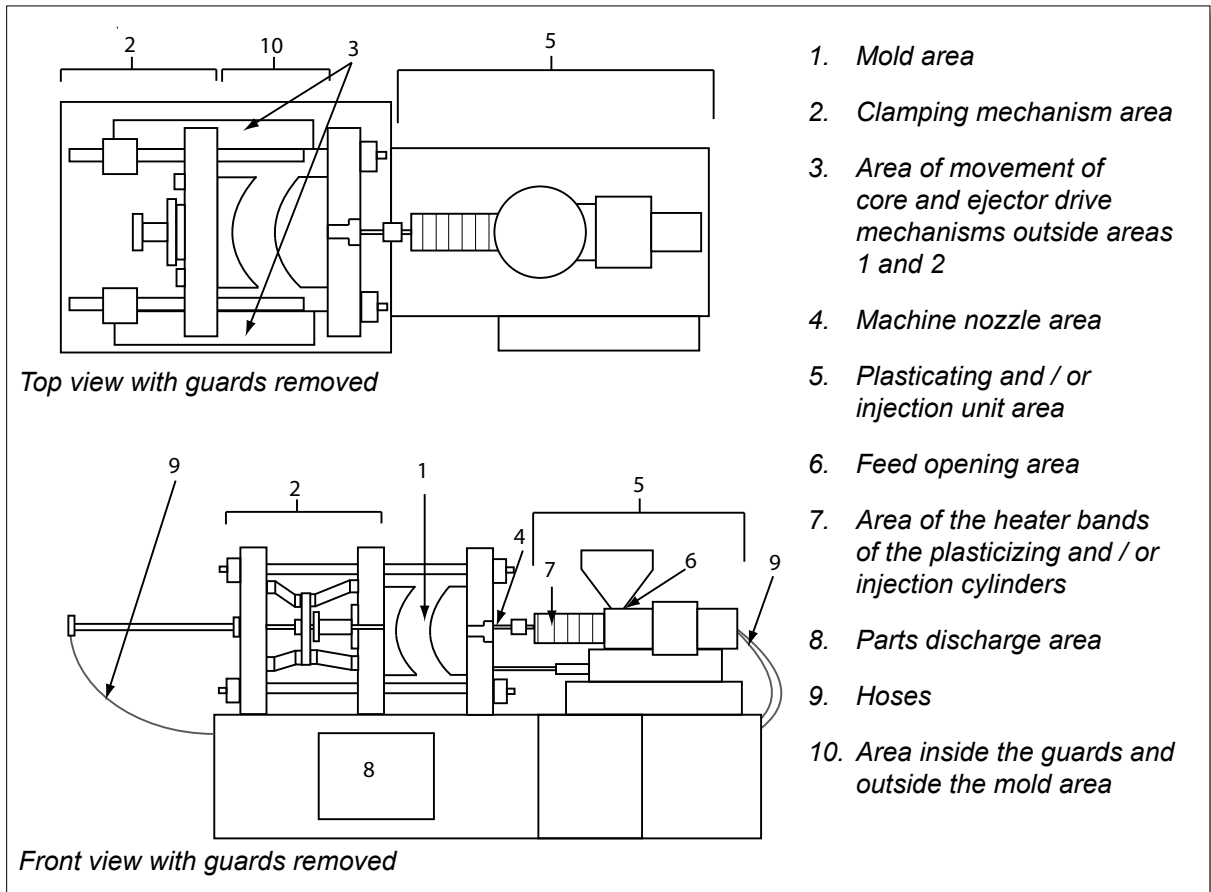

Figure 3-1 Injection molding machine hazard areas

Safety Hazards - continued

Table 3-1 Safety Hazards	
Hazard Area	Potential Hazards
<p>Mold Area Area between the platens. See Figure 3-1 area 1</p>	<p>Mechanical Hazards Crushing and / or shearing and / or impact hazards caused by:</p> <ul style="list-style-type: none"> • Movement of the platen. • Movements of the injection barrel(s) into the mold area. • Movements of cores and ejectors and their drive mechanisms. • Tie bar motion. <p>Thermal Hazards Burns and / or scalds due to operating temperature of:</p> <ul style="list-style-type: none"> • The mold heating elements. • Material released from/through the mold.
<p>Clamping Mechanism Area See Figure 3-12 area 2</p>	<p>Mechanical Hazards Crushing and / or shearing and / or impact hazards caused by:</p> <ul style="list-style-type: none"> • Movement of the platen. • Movement of the drive mechanism of the platen. • Movement of the core and ejector drive mechanism.
<p>Movement of Drive Mechanisms Outside the Mold Area and Outside the Clamping Mechanism Area See Figure 3-1 area 3</p>	<p>Mechanical Hazards Mechanical hazards of crushing, shearing and / or impact caused by the movements of:</p> <ul style="list-style-type: none"> • Core and ejector drive mechanisms.
<p>Nozzle Area The nozzle area is the area between the barrel and the sprue bushing. See Figure 3-1 area 4</p>	<p>Mechanical Hazards Crushing, shearing hazards and / or impact hazards caused by:</p> <ul style="list-style-type: none"> • Forward movement of the plasticizing and / or injection unit including nozzle. • Movements of parts of the power-operated nozzle shutoff and their drives. • Over pressurization in the nozzle. <p>Thermal Hazards Burns and or scalds due to operating temperature of:</p> <ul style="list-style-type: none"> • The nozzle. • Material discharging from the nozzle.
<p>Plasticizing and / or Injection Unit Area Area from the adapter / barrel head / end cap to the extruder motor above the sled including the carriage cylinders. See Figure 3-1 area 5</p>	<p>Mechanical Hazards Crushing, shearing and / or drawn-into hazards caused by:</p> <ul style="list-style-type: none"> • Unintentional gravity movements e.g. for machines with plasticizing and / or injection unit positioned above the mold area. • The movements of the screw and / or the injection plunger in the cylinder accessible through the feed opening. • Movement of the carriage unit. <p>Thermal Hazards Burns and / or scalds due to operating temperature of:</p> <ul style="list-style-type: none"> • The plasticizing and / or injection unit. • The heating elements e.g. heater bands. • The material and / or vapors discharging from the vent opening, feed throat or hopper. <p>Mechanical and / or Thermal Hazard</p> <ul style="list-style-type: none"> • Hazards due to reduction in mechanical strength of the plasticizing and / or injection cylinder due to overheating.
<p>Feed Opening See Figure 3-1 area 6</p>	<p>Pinching and crushing between injection screw movement and housing.</p>

Safety Hazards - continued

Table 3-1 Safety Hazards	
Hazard Area	Potential Hazards
Area of the Heater Bands of the Plasticizing and / or Injection Cylinders See Figure 3-1 area 7	Burns and / or scalds due to operating temperature of: <ul style="list-style-type: none"> • The plasticizing and / or injection unit. • The heating elements e.g. heater bands. • The material and / or vapors discharging from the vent opening, feed throat or hopper.
Parts Discharge Area See Figure 3-1 area 8	Mechanical Hazards Accessible Through the Discharge Area Crushing, shearing and / or impact hazards caused by: <ul style="list-style-type: none"> • Closing movement of the platen. • Movements of cores and ejectors and their drive mechanisms. Thermal Hazards Accessible through the discharge area Burns and or scalds due to operating temperature of: <ul style="list-style-type: none"> • The mold. • Heating elements of the mold. • Material released from / through the mold.
Hoses See Figure 3-1 area 9	<ul style="list-style-type: none"> • Whipping action caused by hose assembly failure. • Possible release of fluid under pressure that can cause injury. • Thermal hazards associated with hot fluid.
Area Inside the Guards and Outside the Mold Area See Figure 3-1 area 10	Crushing and / or shearing and / or impact hazards caused by: <ul style="list-style-type: none"> • Movement of the platen. • Movement of the drive mechanism of the platen. • Movement of the core and ejector drive mechanism. • Clamp opening movement.
Electrical Hazards	<ul style="list-style-type: none"> • Electrical or electromagnetic disturbance generated by the motor control unit. • Electrical or electromagnetic disturbance that can cause failures in the machine control systems and adjacent machine controls. • Electrical or electromagnetic disturbance generated by the motor control unit.
Hydraulic Accumulators	High pressure discharge.
Power Operated Gate	Crush or impact hazards caused by the movement of the power operated gates.
Vapors and Gases	Certain processing conditions and / or resins can cause hazardous fumes or vapors.



3.3 Operational Hazards













WARNINGS

- Refer to all machine manuals and local regulations and codes for safety information.
- The equipment supplied is subjected to high injection pressures and high temperatures. Ensure that extreme caution is observed in the operation and maintenance of the injection molding machines.
- Only fully trained personnel should operate or maintain equipment.
- Do not operate the equipment with unconfined long hair, loose clothing or jewelry, including name badges, neckties, etc. These may get caught in the equipment and can cause death or serious injury.
- Never disable or bypass a safety device.
- Ensure that the protective guards are placed around the nozzle to prevent the material from splashing or drooling.
- A burn hazard exists from material during routine purging. Wear heat-resistant personal protective equipment (PPE) to prevent burns from contact with hot surfaces or splatter of hot material and gases.
- Material purged from machine may be extremely hot. Ensure protective guards are in place around the nozzle to prevent material from splashing. Use proper personal protective equipment.
- All operators should wear personal protective equipment, such as face shields and use heat resistant gloves when working around the feed inlet, purging the machine or cleaning the gates of the mold.
- Remove purged material from the machine immediately.
- Decomposing or burning material could result in noxious gases being emitted from the purged material, feed inlet or mold.
- Ensure proper ventilation and exhaust systems are in place to help prevent inhalation of harmful gases and vapors.
- Consult manufacturer's Material Safety Data Sheets (MSDS).
- Hoses fitted to the mold will contain high or low temperature fluids or air under high pressure. The operator must shut down and lockout these systems as well as relieving any pressure before performing any work with these hoses. Regularly inspect and replace all flexible hoses and restraints.
- Water and / or hydraulics on the mold may be in close proximity to electrical connections and equipment. Water leakage may cause an electrical short circuit. Hydraulic fluid leakage may cause a fire hazard. Always keep water and / or hydraulic hoses and fittings in good condition to avoid leaks.
- Never perform any work on the mold machine unless the hydraulic pump has been stopped.
- Check frequently for possible oil leaks / water leaks. Stop the machine and make repairs.



Operational Hazards - continued**WARNING**

- Make sure that the cables are connected to the correct motors. Cables and motors are clearly labeled. Reversing the cables can result in unexpected and uncontrolled motion causing a safety risk or damage to the machine.
- A crushing hazard exists between the nozzle and mold melt inlet during carriage forward motion.
- A possible shearing hazard exists between the edge of the injection guard and the injection housing during injection.
- The open feed port could present a hazard to a finger or a hand inserted during operation of the machine.
- The electric servo motors could overheat presenting a hot surface which could cause burns to someone touching it.
- The barrel, barrel head, nozzle, heater bands and mold components are hot surfaces which could result in burns.
- Keep flammable liquids or dust away from the hot surfaces as they could ignite.
- Follow good housekeeping procedures and keep floors clean to prevent slips, trips and falls due to spilled material on the work floor.
- Apply engineering controls or hearing conservation programs as necessary to control noise.
- When doing any work on the machine that requires moving and lifting the machine, ensure that lifting equipment (eyebolts, fork lift truck, cranes, etc.) will have sufficient capacity to handle mold, auxiliary injection unit or Hot Runner weight.
- Connect all lifting devices and support the machine using a crane of adequate capacity before commencing work. Failure to support the machine can result in severe injury or death.
- Mold cable from the controller to the mold must be removed before servicing the mold.

3.4 General Safety Symbols

Table 3-2 Typical Safety Symbols	
Symbol	General Description
	General – Warning Indicates an immediate or potentially hazardous situation, which if not avoided, could result in a serious injury or death, and / or damage to equipment.
	Warning – Barrel Cover Grounding Strap Lockout / tagout procedures must be followed before removing the barrel cover. Barrel cover can become energized upon removal of grounding straps and contact can result in death or serious injury. Grounding straps must be reconnected before reconnecting power to machine.
	Warning – Crushing and / or Impact Points Contact with moving parts can cause serious crushing injury. Always keep guards in place.
	Warning – Crush Hazard Closing Mold
	Warning – Hazardous Voltage Contact with hazardous voltages will cause death or serious injury. Turn off power and review electrical schematics before servicing equipment. May contain more than one live circuit. Test all circuits before handling to make sure circuits have been de-energized.
	Warning – High Pressure Overheated fluids may cause severe burns. Discharge pressure before disconnecting water lines.
	Warning – High Pressure Accumulator Sudden release of high pressure gas or oil can cause death or serious injury. Discharge all gas and hydraulic pressure before disconnecting or disassembling accumulator.
	Warning – Hot Surfaces Contact with exposed hot surfaces will cause serious burn injury. Wear protective gloves when working near these areas.
	Mandatory – Lockout / Tagout Ensure that all energies are properly locked out, and remain locked out until the service work is completed. Servicing equipment without disabling all internal and external power sources can cause death or serious injury. De-energize all internal and external power sources (electrical, hydraulic, pneumatic, kinetic, potential, and thermal).
	Warning – Molten Material Splashing Hazard Molten material or high pressure gas can cause death or severe burns. Wear personal protective equipment while servicing the feed throat, nozzle, mold areas and when purging the injection unit.
	Warning – Read Manual Before Operation Personnel should read and understand all instructions in the manuals before working on equipment. Only properly trained personnel should operate the equipment.
	Warning – Slip, Trip or Fall Hazard Do not climb on equipment surfaces. Serious slip, trip, or fall injuries can result from personnel climbing on equipment surfaces.

General Safety Symbols - continued

Table 3-2 Typical Safety Symbols	
Symbol	General Description
	Caution Failure to follow instructions may damage equipment.
	Important Indicates additional information or used as a reminder.

3.5 Wiring Check



CAUTION

System Mains Supply Wiring:

- Before connecting the system to a power supply, it is important to check that the wiring between the system and the power supply has been done correctly.
- Particular attention must be given to the current rating of the power supply. For example, if a controller is rated at 63A, then the power supply must also be rated at 63A.
- Check that the phases of power supply are wired correctly.

Controller to Mold Wiring:

- For separate power and thermocouple connections, ensure that the power cables are never connected to the thermocouple connectors and vice-versa.
- For mixed power and thermocouple connections, ensure that the power and thermocouple connections have not been wired incorrectly.

Communications Interface and Control Sequence:

- It is the customer's responsibility to verify functionality of any custom machine interface at safe speeds, prior to operating equipment in the production environment at full speed in automatic mode.
- It is the customer's responsibility to verify all required motion sequences are correct, prior to operating equipment in the production environment at full speed in automatic mode.
- Switching the machinery into Auto mode without having verified the control interlocks and motion sequence are correct, may cause damage to machinery and / or equipment.

Failure to do wiring or connections properly will result in equipment failure.



3.6 Lockout Safety

WARNING

DO NOT enter the cabinet without first ISOLATING the supplies.

Voltage and amperage cables are connected to the controller and the mold. Electric power must be shut off and lockout / tagout procedures followed prior to installing or removing any cables.

Use lockout / tagout to prevent operation during maintenance.

All maintenance should be performed by properly trained personnel based on local laws and regulation. Electrical products may not be grounded when removed from the assembled or normal operating condition.

Ensure proper grounding of all electrical components before performing any maintenance to avoid potential risk of electrical shock.

Often power sources are inadvertently turned on or valves are opened mistakenly before maintenance work is completed, resulting in serious injuries and fatalities. Therefore, it is important to ensure that all energies are properly locked out and that they remain locked out until the work is completed.

If a lockout is not performed, uncontrolled energies could cause:

- Electrocutation from contact with live circuits
- Cuts, bruises, crushing, amputations or death, resulting from entanglement with belts, chains, conveyors, rollers, shafts, impellers
- Burns from contact with hot parts, materials or equipment such as furnaces
- Fires and explosions
- Chemical exposures from gases or liquids released from pipelines

3.6.1 Electrical Lockout

Employers must provide an effective lockout / tagout program.



WARNING - READ MANUAL

Refer to all machine manuals and local regulations and codes.

NOTE

In some instances, there may be more than one power source feeding equipment and steps must be taken to ensure that all sources are effectively locked out.

1. Shut down machine using normal operational shutdown procedure and controls. This should be done by, or in consultation with the machine operator.
2. After ensuring that the machinery has been completely shut down, and all controls in the “off” position, open the main disconnect switch located in the field.
3. Using your own personal padlock, or one assigned by your supervisor, lock the disconnect switch in the off position. Do not lock only the box. Remove the key and retain. Complete a lockout tag and affix to the disconnect switch. Each person working on the equipment must follow this step. The lock of the person doing the work or in charge must be installed first, remain throughout and be removed last. Test the main disconnect switch and make sure it cannot be moved to the “on” position.
4. Try to start the machine using the normal operation controls and point of operation switches to make sure that the power has been disconnected.
5. Other sources of energy that could create a hazard while working on the equipment must also be de-energized and appropriately “locked-out”. This can include gravity, compressed air, hydraulics, steam and other pressurized or hazardous liquids and gases (see table below).
6. When the work is completed, prior to removing the last lock, make sure the operational controls are in the “off” position so that the main disconnect switching is done under “no load”. Ensure all blocks, tools and other foreign materials are removed from machine. Also ensure that all personnel that may be affected are informed that the lock(s) will be removed.
7. Remove lock and tag, and close the main disconnect switch if permission has been given.
8. When the work has not been completed on the first shift, the next operator should install a personal lock and tag before the first operator removes the original lock and tag. If the next operator is delayed, a lock and tag could be installed by the next supervisor. Lockout procedures should indicate how the transfer is to be conducted.
9. It is important that, for their personal protection, each worker and/or fore person working in or on a machine places his/her own safety lock on the disconnect switch. Use tags to spotlight work in progress and give details of work being done. Only when the work is completed and the work permit signed off, may each worker remove his/her lock. The last lock to be removed should be that of the person supervising the lockout and this responsibility should not be delegated.

© Industrial Accident Prevention Association, 2008.

3.6.2 Energy Forms and Lockout Guidelines

Table 3-3 Energy Forms, Energy Sources and General Lockout Guidelines		
Energy Form	Energy Source	Lockout Guidelines
Electrical Energy	<ul style="list-style-type: none"> Power transmission lines Machine power cords Motors Solenoids Capacitors (stored electrical energy) 	<ul style="list-style-type: none"> Turn off power at machine first (i.e., at point of operation switch), and then at the main disconnect switch for the machine. Lock and tag the main disconnect switch. Fully discharge all capacitive systems (e.g., cycle machine to drain power from capacitors) according to the manufacturer's instructions.
Hydraulic Energy	<ul style="list-style-type: none"> Hydraulic systems (e.g., hydraulic presses, rams, cylinders, hammers) 	<ul style="list-style-type: none"> Shut off, lock (with chains, built-in lockout devices, or lockout attachments) and tag valves. Bleed off and blank lines as necessary.
Pneumatic Energy	<ul style="list-style-type: none"> Pneumatic systems (e.g., lines, pressure reservoirs, accumulators, air surge tanks, rams, cylinders) 	<ul style="list-style-type: none"> Shut off, lock (with chains, built-in lockout devices, or lockout attachments) and tag valves. Bleed off excess air. If pressure cannot be relieved, block any possible movement of machinery.
Kinetic Energy (Energy of a moving object or materials. Moving object may be powered or coasting)	<ul style="list-style-type: none"> Blades Flywheels Materials in supply lines 	<ul style="list-style-type: none"> Stop and block machine parts (e.g. stop flywheels and ensure that they do not recycle). Review entire cycle of mechanical motion, ensure that all motions are stopped. Block material from moving into area of work. Blank as necessary.
Potential Energy (Stored energy that an object has the potential to release due to its position)	<ul style="list-style-type: none"> Springs (e.g., in air brake cylinders) Actuators Counterweights Raised loads Top or movable part of a press or lifting device 	<ul style="list-style-type: none"> If possible, lower all suspended parts and loads to the lowest (rest) position. Block parts that might be moved by gravity. Release or block spring energy.
Thermal Energy	<ul style="list-style-type: none"> Supply lines Storage tanks and vessels 	<ul style="list-style-type: none"> Shut off, lock (with chains, built-in lockout devices, or lockout attachments) and tag valves. Bleed off excess liquids or gases. Blank lines as necessary.

3.7 Grounded Earth Connections

Grounded earth connections are found in the following locations on the E-Multi controller:

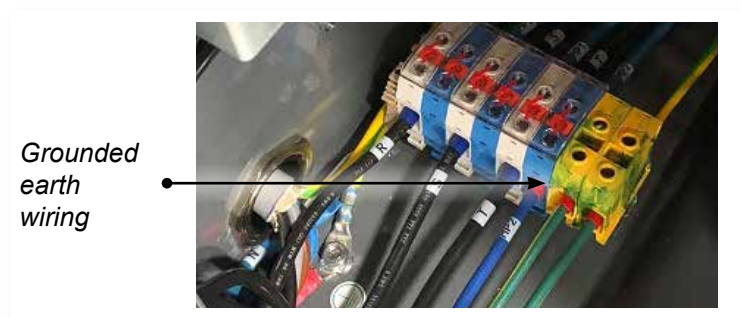
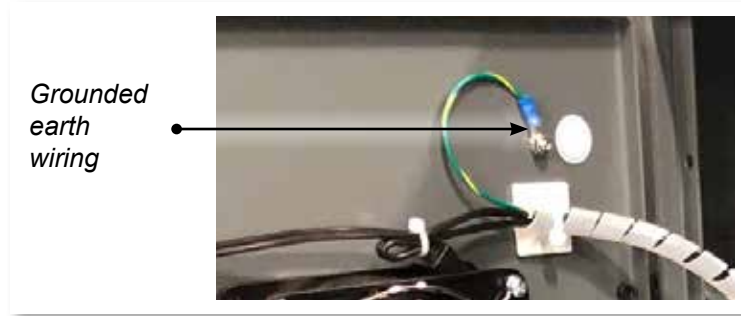

3.8 Disposal



WARNING

Milacron *Mold-Masters* declines any responsibility for personal injury or personal damage arising from reuse of the individual components, if these parts are used other than for the original and proper intended purpose.

1. Hot runner and system components must be disconnected from the power supply fully and properly before disposal, including electricity, hydraulics, pneumatics and cooling.
2. Ensure that the system to be disposed of is free from fluids. In the case of hydraulic needle valve systems, drain the oil from the lines and cylinders and dispose it in an environmentally responsible manner.
3. The electrical components are to be dismantled, separating them accordingly as environmentally-friendly waste or disposed as hazardous waste if necessary.
4. Remove the wiring. The electronic components are to be disposed in accordance with the national electric scrap ordinance.
5. The metal parts are to be returned for metal recycling (waste metal and scrap trade). The instructions of the corresponding waste disposal company are to be observed in this case.

Recycling of all possible materials should be at the forefront of the disposal process.

3.9 E-Multi Controller Safety Hazards

See also “Figure 3-2 E-Multi controller safety hazards” on page 3-14.



WARNING - ELECTRICAL SHOCK HAZARD

It is crucial to comply with these warnings to minimize any personal danger.

- Ensure that all energies are properly locked out in the controller and molding machine before installation of the controller into the system.
- DO NOT enter the cabinet without first ISOLATING the supplies OR having a qualified person selecting the BYPASS SWITCH to ON, to gain live access to the controller. There are unguarded terminals inside the cabinet which may have a dangerous potential across them. Where a three-phase supply is used, this potential may be up to 600VAC.
- With the BYPASS SWITCH set to OFF opening the high power section of the controller will cause the circuit breaker to TRIP, disconnecting all power to the cabinet.
- Voltage and amperage cables are connected to the controller and the mold. There is also a voltage cable connection between the servo motor and the controller. Electric power must be shut off and lockout / tagout procedures followed prior to installing or removing any cables.
- Integration should be done by properly trained personnel based on local codes and regulations. Electrical products may not be grounded when removed from the assembled or normal operating condition.
- Do not mix electrical power cables with thermocouple extension cables. They are not designed to carry the power load or list accurate temperature readings in each other’s application.



WARNING

Do not make changes to the factory settings without the help of *Mold-Masters* service personnel. Changes to these settings can result in hazardous out-of-control or unexpected movement. It can also damage the machine and voids the warranty.

3.9.1 Operational Environment

The E-Multi controller should be installed in a clean, dry environment where the ambient conditions do not exceed the following limits:

- Temperature: +5 to +45°C
- Relative Humidity: 90% (non-condensing)

3.9.2 Cabinet Push / Tip Forces

Table 3-4 Cabinet Push / Tip Forces		
	EM1 / EM2 / EM3 Cabinet	EM4 Cabinet
Force required to move cabinet on castors	13 lbs (6KG F)	35 lbs (16KG F)
Force required to tip cabinet if one castor is missing	150lbs (68KG F)	200 lbs (91KG F)

E-Multi Controller Safety Hazards - continued

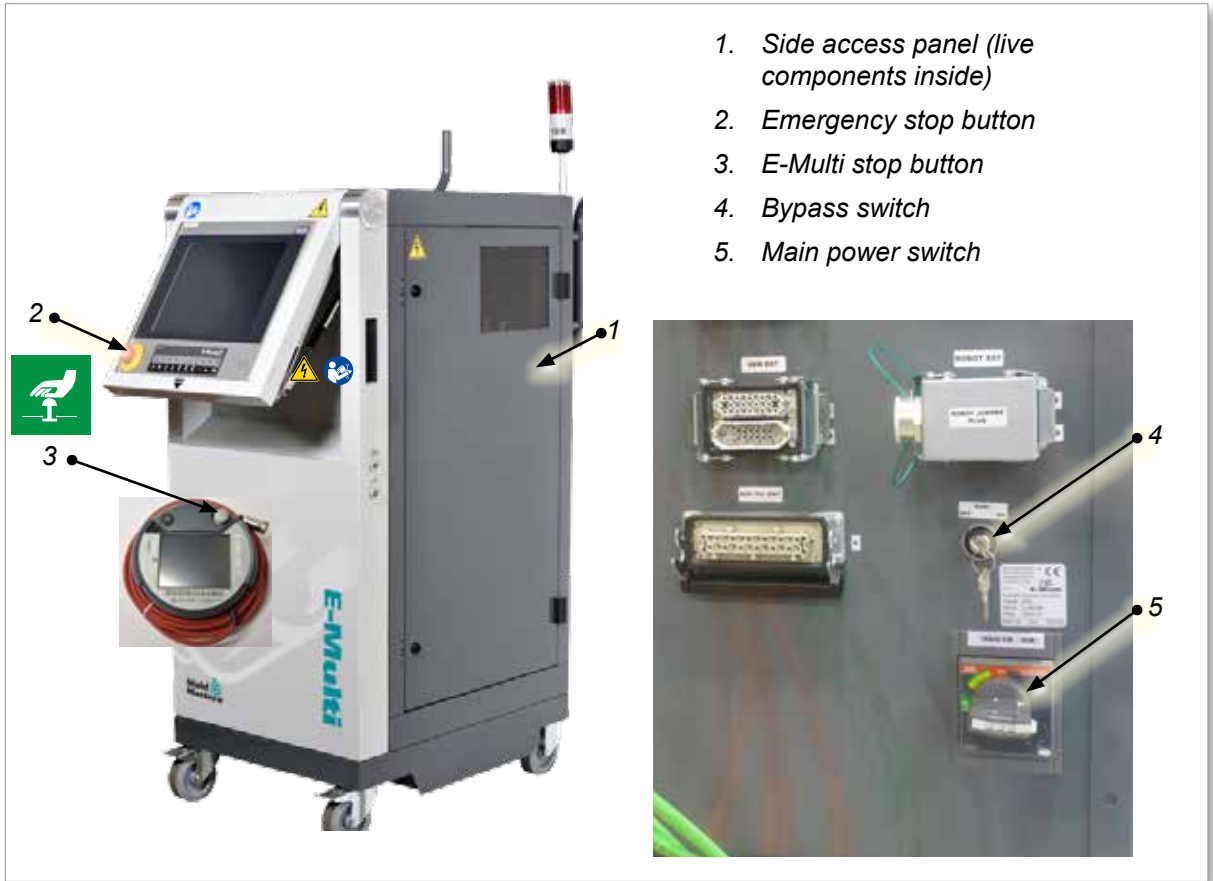

Figure 3-2 E-Multi controller safety hazards

3.10 E-Multi Injection Unit Safety Labels

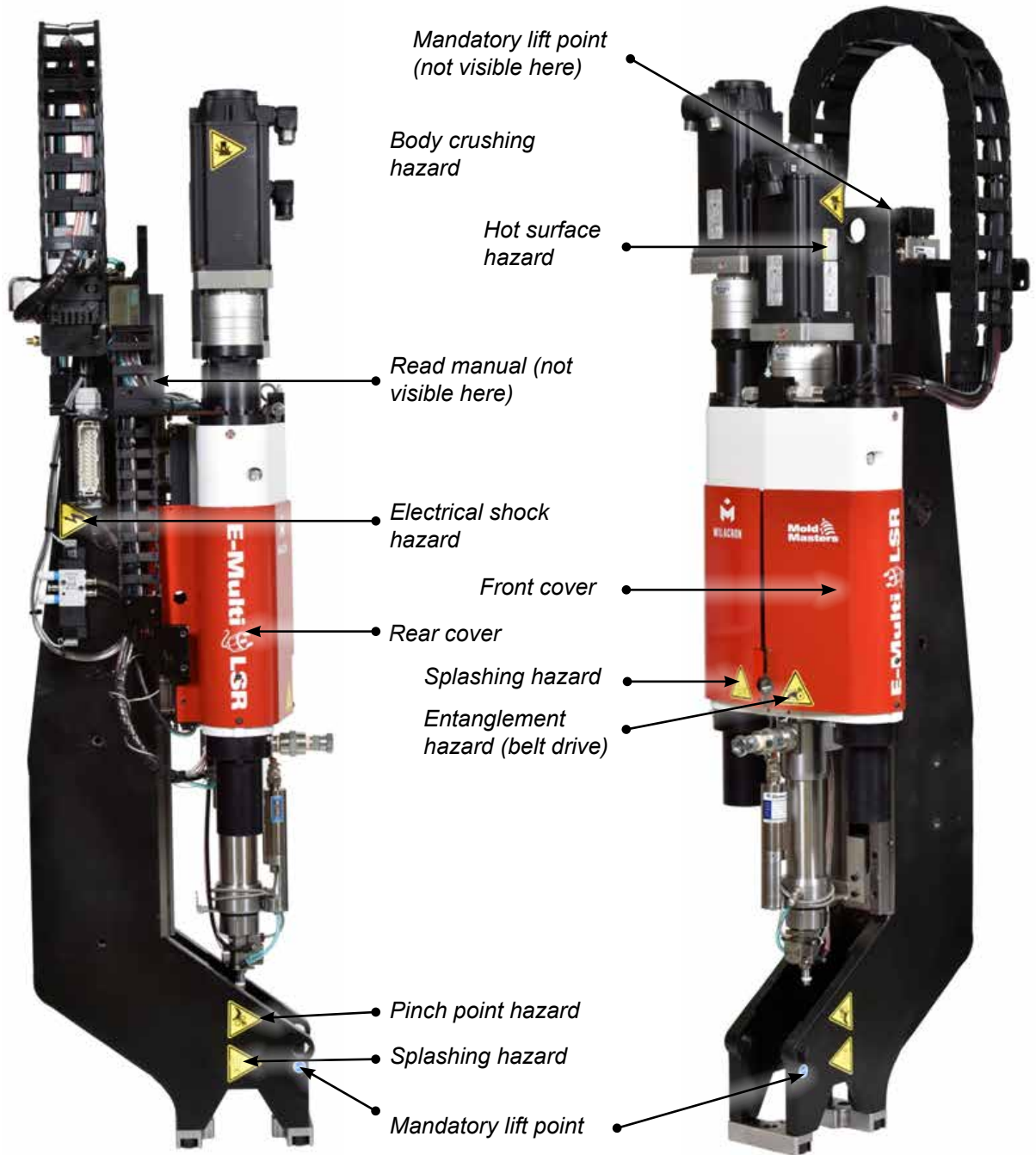

Figure 3-3 E-Multi injection unit safety labels

Please refer to “Table 3-6 Safety Symbols Used on the E-Multi Injection Unit” on page 3-18 for full hazard descriptions.











3.11 E-Multi Injection Unit Safety Hazards

Table 3-5 E-Multi Injection Unit Safety Hazard Details	
Hazard Type	Potential Hazards
Mechanical Hazards	
Body Crushing Hazard	End of motor moves back during operation. A hazard may exist between the end of the injection unit motor assembly and a nearby solid obstacle. Ensure proper guarding as part of integration.
	During installation of the E-Multi injection unit onto a mold, a crushing hazard exists between the adapter plate and the mounting surface of the mold.
	A crushing hazard exists between nozzle and mold melt inlet during carriage forward motion.
Shearing Hazard	A possible shearing hazard exists between the edge of the injection guard and the injection housing during injection.
Cutting Hazard	For horizontally-mounted machines with a high center line height, a person's head could hit the end of the injection unit causing a cut. Ensure proper guarding.
Entanglement Hazard (Belt Drive)	A person could become entangled in the drive belt or screw of the injection unit. Always keep guards in place.
Entanglement Hazard	The open feed port could present an entanglement hazard. Always keep guards in place.
Cutting or Severing Hazard	For units equipped with a servo carriage, a severing hazard may exist between the barrel assembly and support beam when the carriage moves forward and the hard stop extension in the trunnion slot is not installed.
High Pressure Fluid or High Temperature Molten Material Splashing Hazard	High pressure fluid or high temperature molten material may spray from the nozzle. Always use personal protective equipment (PPE).
	High pressure material or high temperature molten material may spray from a blocked feed port. Always use personal protective equipment.
Loss of Stability	Injection unit could fall over if improperly installed on stand.
	Injection unit could fall over if transported on stand castors.
	Injection unit could fall from top of mold if not properly secured.
	Injection unit could fall over if stored vertically on the floor or a table without adequate support.
Trip Hazard	Controller cables are a tripping hazard on the floor between the controller and the press or E-Multi injection unit.
Stored Energy	There could be stored energy in compressed material which is not released when the machine is powered off.
	When installed vertically and powered off, there is stored energy in the injection assembly which could move downwards.
Electrical Hazard	
Contact of Persons with High Voltage	Heaters, servo motors and electrical components in the controller could come in contact with a person. Do not remove covers when energized.
Thermal Hazards	
Possible Contact of Persons with High Temperature Material	The injection barrel could result in burns.
	Melted material during routine purging could cause burns.
	Hot material or gases could be released from the feed port when clearing a blockage.
	The electric servo motors could overheat presenting a hot surface which could cause burns to someone touching it.

E-Multi Injection Unit Safety Hazards - continued

Table 3-4 E-Multi Injection Unit Safety Hazard Details	
Hazard Type	Potential Hazards
Hazards Generated By Materials or Substances	
Hazards from Contact With or Inhalation of Harmful Gases	Hot material could result in harmful gases being emitted from the purged material, feed inlet or mold.
Fire or Explosion Hazard	Hot surfaces of the barrel heaters could ignite flammable liquids or dust.
Ergonomic Hazards	
Lift Hazard	Attempting to lift or support the unit during installation could result in injury.
Combination Hazards	
Failure / Disorder of Control System	Incorrect connections can result in out-of-control or unexpected movement causing damage to the machine and a possible hazard.
Errors of Fitting	Incorrect design of the adapter plate, or tool interface or attachment, or improper torquing of mounting fasteners may result in a failure of the connection and subsequent loss of stability or falling of the machine.

3.12 E-Multi Injection Unit Safety Symbols

Table 3-6 Safety Symbols Used on the E-Multi Injection Unit	
Symbol	General Description
	General – Warning Indicates an immediate or potentially hazardous situation, which if not avoided, could result in a serious injury or death, and / or damage to equipment.
	Warning – Body Crush Hazard End of motor moves back during hold or recovery. Hazard may exist between the end of the injection unit motor assembly and a nearby solid obstacle.
	Warning – Tip Over Hazard Injection unit could tip over when installed on stand or if stored vertically on the floor or a table without adequate support.
	Warning – Electric Shock Hazard Contact with hazardous voltages will cause death or serious injury. Turn off power and review electrical schematics before servicing equipment. May contain more than one live circuit. Test all circuits before handling to make sure circuits have been de-energized.
	Warning – Hot Surface Hazard Contact with exposed hot surfaces will cause serious burn injury. Wear adequate personal protective equipment (PPE) when working near these areas.
	Warning – Entanglement Hazard (Belt Drive) A person could become entangled in the drive belt of the injection unit. Always keep guards in place.
	Warning - Pinch Point Hazard A pinch point exists in this area which could result in a pinching, crushing or shearing injury to a person.
	Warning – Splashing Hazard Material or high pressure gas can cause death or severe burns. Wear personal protective equipment (PPE) while servicing the feed throat, nozzle, mold areas, and when purging the injection unit.
	Mandatory – Read Service Manual Before Operation Personnel should read and understand all instructions in the manuals before working on equipment. Only properly trained personnel should operate the equipment.
	Mandatory Lift Points Mandatory lift points must be used. If wrong lift points are used the unit could become unstable when being moved.

3.13 E-Multi Injection Unit Safety Guards



WARNING

Guards should not be removed unless maintenance is required and should be replaced after maintenance is complete. Do not run the machine with guards removed.



CAUTION

When installing the machine guards (front and rear covers) and the barrel covers, check that they do not pinch water lines, air lines or thermocouple wires when the unit moves.

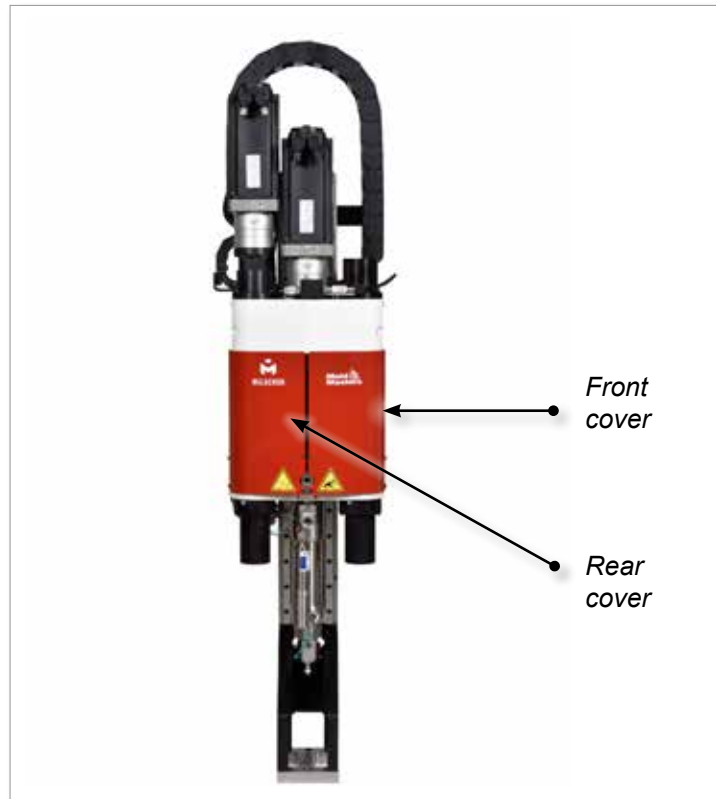

Figure 3-4 Guards layout

3.14 E-Multi Weight Specifications

Dimensions and weights shown are for packed wooden crates containing standard-optional units. Additional options may add weight or require additional crates. Specifications subject to changes without notice.

Table 3-7 E-Multi Injection Unit Shipping Dimensions and Weight					
Model		Length mm (in.)	Width mm (in.)	Height mm (in.)	Weight kg (lb)
EM1/EM2		1520 (60)	740 (29)	840 (33)	300 (660)
EM3		2080 (82)	840 (33)	910 (36)	500 (1100)
EM4		3302 (130)	914 (36)	991 (39)	1300 (2860)
ER1-15		1632 (64)	932 (37)	1056 (42)	400 (880)
ER1-30	400 (880)				
ER2-50	400 (880)				
ER2-80	500 (1100)				
ER3-100	Crate 1	3302 (130)	914 (36)	991 (39)	900 (1980)
	Crate 2	1543 (61)	975 (38)	670 (26)	700 (1540)
ER3-200	Crate 1	3302 (130)	914 (36)	991 (39)	900 (1980)
	Crate 2	1543 (61)	975 (38)	670 (26)	700 (1540)
ER4-350	Crate 1	3302 (130)	914 (36)	991 (39)	1200 (2640)
	Crate 2	1543 (61)	975 (38)	670 (26)	700 (1540)
ER4-550	Crate 1	3302 (130)	914 (36)	991 (39)	1300 (2860)
	Crate 2	1543 (61)	975 (38)	670 (26)	700 (1540)
EM1/EM2/EM3 Controllers		1702 (67)	788 (31)	1626 (64)	390 (860)
EM4 Controller		1880 (74)	788 (31)	1626 (64)	600 (1330)

3.15 Unpack the E-Multi Controller

1. Identify the correct side of the crate to open. This side is marked with the phrase “FRAGILE OPEN THIS SIDE”. See Figure 3-5.



Figure 3-5 Correct side of crate to open

2. Remove top row of screws from the long side of the crate. See Figure 3-6.

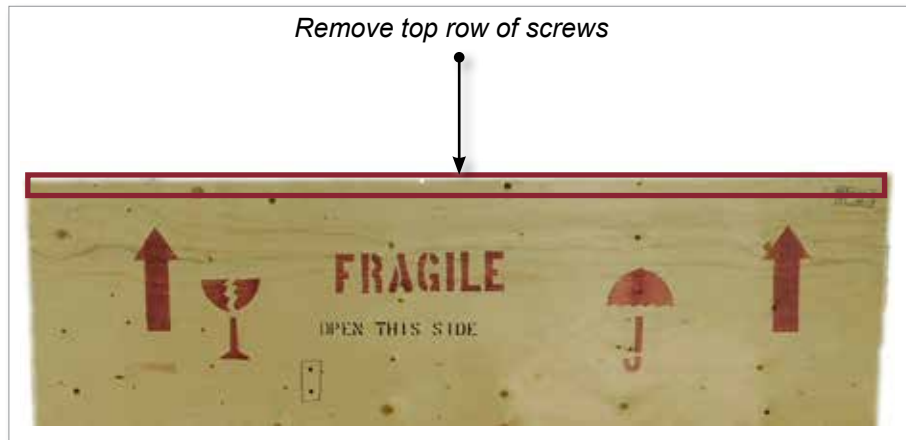

Figure 3-6 Remove top row of screws

3. Remove screws from top of crate and remove the top of the crate.

Unpack the E-Multi Controller - continued

- From the side of the crate marked with “FRAGILE OPEN THIS SIDE”, remove the cross brace screws. See Figure 3-7.

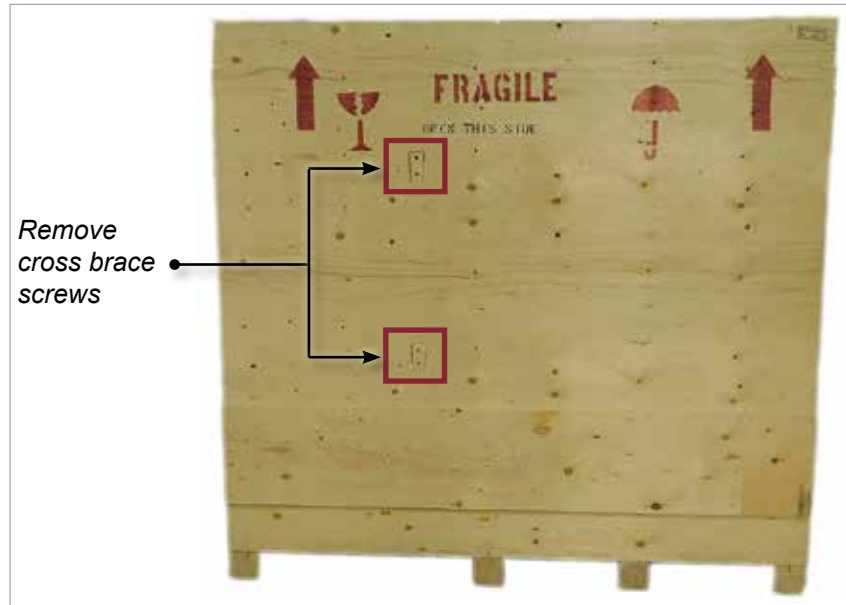

Figure 3-7 Remove cross brace screws

- From the side of the crate marked with “FRAGILE OPEN THIS SIDE”, remove the screws down the sides and at the bottom of the crate. See Figure 3-8.

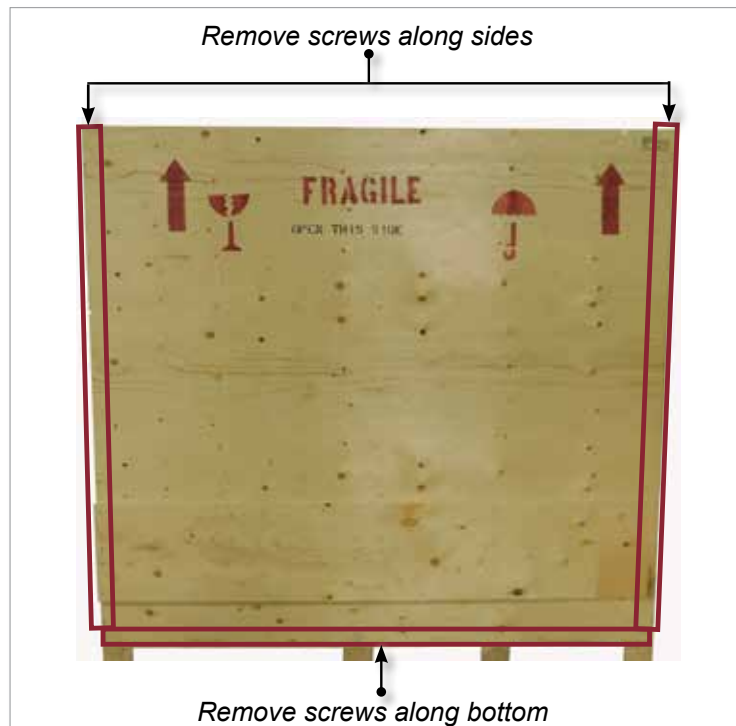

Figure 3-8 Remove screws from side and bottom

- Remove the side of the crate marked with “FRAGILE OPEN THIS SIDE”.
- Remove the remaining four screws holding the braces on the opposite side of the crate and remove the braces.

3.16 Lift the E-Multi Controller

3.16.1 Preparation



WARNING

Always ensure that all lifting devices are in good repair and of adequate capacity before commencing work. Failure to lift or support the controller properly can result in severe injury or death and / or damage to the controller.

1. Choose lift equipment that is rated for the prescribed load.
2. Define the **load path**: the path and orientation the item will move in while it is being lifted, and the location and orientation where it will be set down.
3. Identify and avoid potential **pinch points**: where an individual or a component of the lifting equipment or load may be caught between two surfaces.
4. Secure and remove all boxes and accessories from the crate and store in a safe location away from the lift path.
5. Remove all cables not attached to the controller from the crate and store in a safe location away from the lift path.

The E-Multi controller is shipped with four eyebolts with threaded studs and four washers. These components are attached to the keys at the back of the controller. See Figure 3-9.



Figure 3-9 Eyebolts and washers

Unpack the E-Multi Controller - continued

6. Assemble eyebolts and washers and install into the holes on the top of the E-Multi controller. See Figure 3-10.

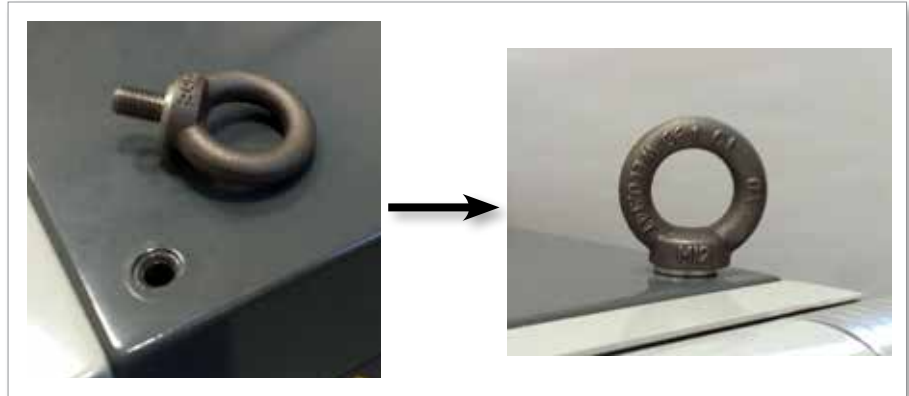

Figure 3-10 Install eyebolts and washers

7. Attach slings to all of the eyebolts. See Figure 3-5.



IMPORTANT

Slings **must** be attached securely to all four eyebolts.

Balance the load in the chain or lifting device before it is lifted more than a few inches.

Minimize swinging by bringing the hook over the load appropriately.

Move powered hoists slowly into engagements with loads.



Figure 3-11 Attach slings to all four eyebolts

8. Lift the E-Multi controller from the crate.

3.17 Lift the E-Multi Injection Unit



WARNING

When doing any work on the machine that requires lifting the machine, connect all lifting devices and support the machine using a crane of adequate capacity before commencing work. Failure to support the machine can result in severe injury or death.



CAUTION

Do not use the motor as a lifting point.

Table 3-8 E-Multi Injection Unit Lifting Kits	
EM1/EM2	2 x 16 mm (5/8 in.) bow shackles 2 x 1220 mm (48") slings
EM3	2 x 25 mm (1 in.) bow shackles 2 x 1830 mm (72") slings

3.17.1 Prior to Lifting the E-Multi Injection Unit

1. Choose lift equipment that is rated for the prescribed load. See equipment tag.
2. Define the **load path**: the path and orientation the item will move in while it is being lifted, and the location and orientation where it will be set down.
3. Use recommended attachment points only. See Section 3.17.
4. Identify and avoid potential **pinch points**: where an individual or a component of the lifting equipment or load may be caught between two surfaces.
5. Secure and balance the load in the chain or lifting device before it is lifted more than a few inches.
6. Minimize swinging by bringing the hook over the load appropriately.
7. Move powered hoists slowly into engagements with loads.



Figure 3-12 Do not use the motor as a lifting point

3.18 EM1 / EM2 / EM3 Lift Connections



NOTE

Review the information in Section 3.14 before performing any lifting procedure.

3.18.1 EM1 / EM2 / EM3 Vertical Lift Connections

Table 3-9 EM1 / EM2 / EM3 Vertical Lift Connections	
EM1 / EM2	EM3
Connect sling to motor end of the support beam using one 16 mm (5/8 in.) shackle in lifting hole.	Connect sling to motor end of the support beam using a 25 mm (1 in.) shackle in lifting hole.

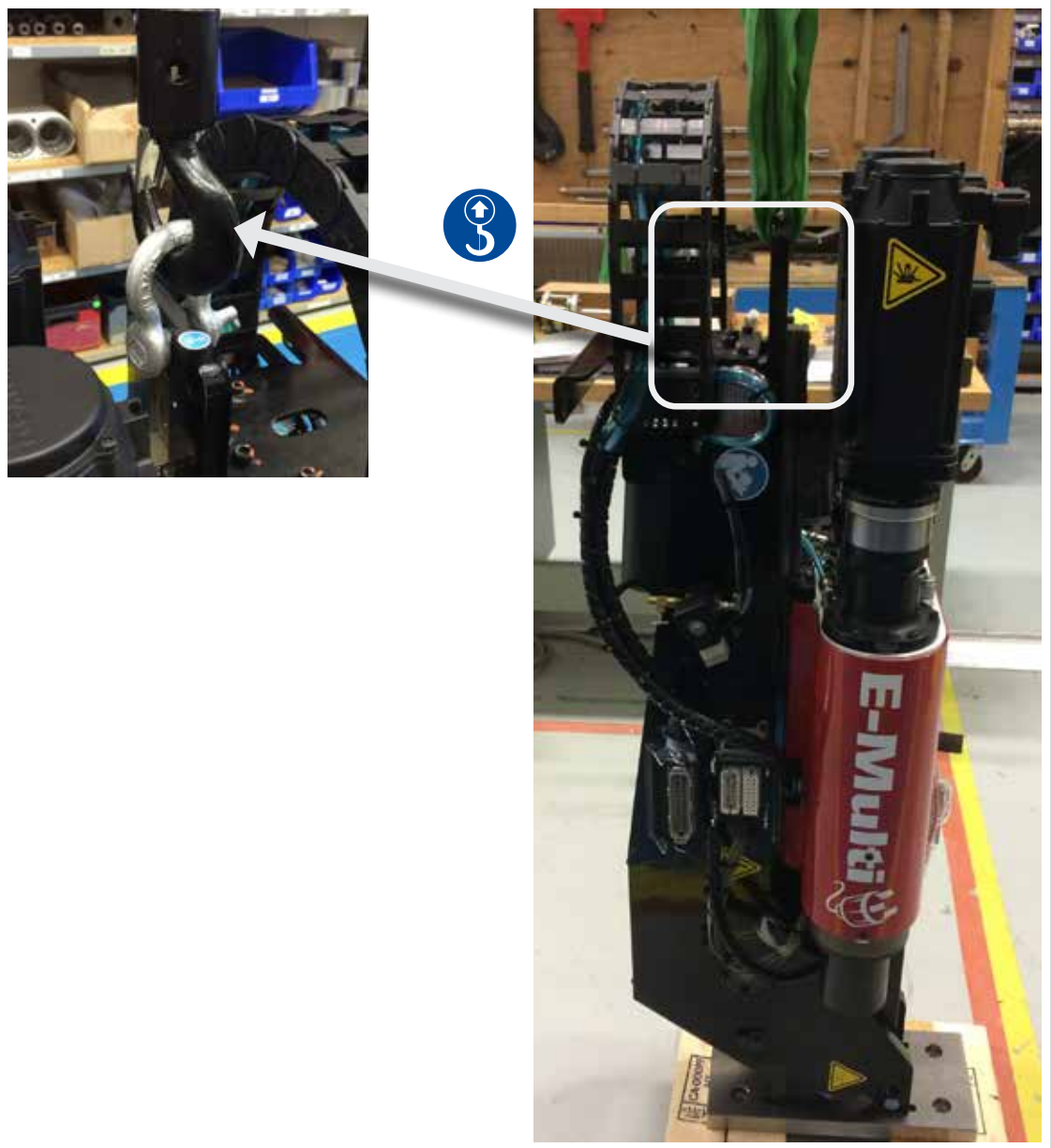

3.18.2 EM1 / EM2 / EM3 Horizontal Lift Connections



NOTE

For best results use an adjustable two leg chain bridge.

Table 3-10 EM1 / EM2 / EM3 Horizontal Lift Connections	
EM1 / EM2	EM3
<p>Connect one sling (A) to motor end of the support beam by feeding it through the lifting hole, with sling on either side of the motor.</p> <p>Connect other sling (B) to barrel end of the support beam using two 16 mm (5/8 in.) shackles in the lifting holes.</p> <p>NOTE: EM1 / EM2 units require blocks or shipping brackets when set down horizontally to prevent damage to the linear actuator.</p>	<p>Connect one sling (A) to motor end of the support beam by feeding it through the lifting hole, with sling on either side of the motor.</p> <p>Connect other sling (B) to barrel end of the support beam using two 25 mm (1 in.) shackles in lifting holes.</p>



3.19 E-Multi Injection Unit Stand Safety

**WARNING**

The stands are intended for supporting E-Multi injection units at the machine when used in the horizontal position. They are not for transporting the E-Multi injection unit and would be top heavy and present a tip hazard. The E-Multi injection unit and stand assembly should be moved together by crane using the proper E-Multi injection unit lift points.

Do not modify stands to reduce or add height, e.g. adding additional holes or not bolting the upper and lower columns together. Such changes would impact the stand stability and could result in serious injury as well as damage to the machine.

Section 4 - Overview

4.1 Controller Front



- 1. Lifting rings
- 2. Alarm indicator light
- 3. Human machine interface (HMI)
- 4. Emergency stop button

Figure 4-1 Controller front

4.2 Controller Back - Connections Side

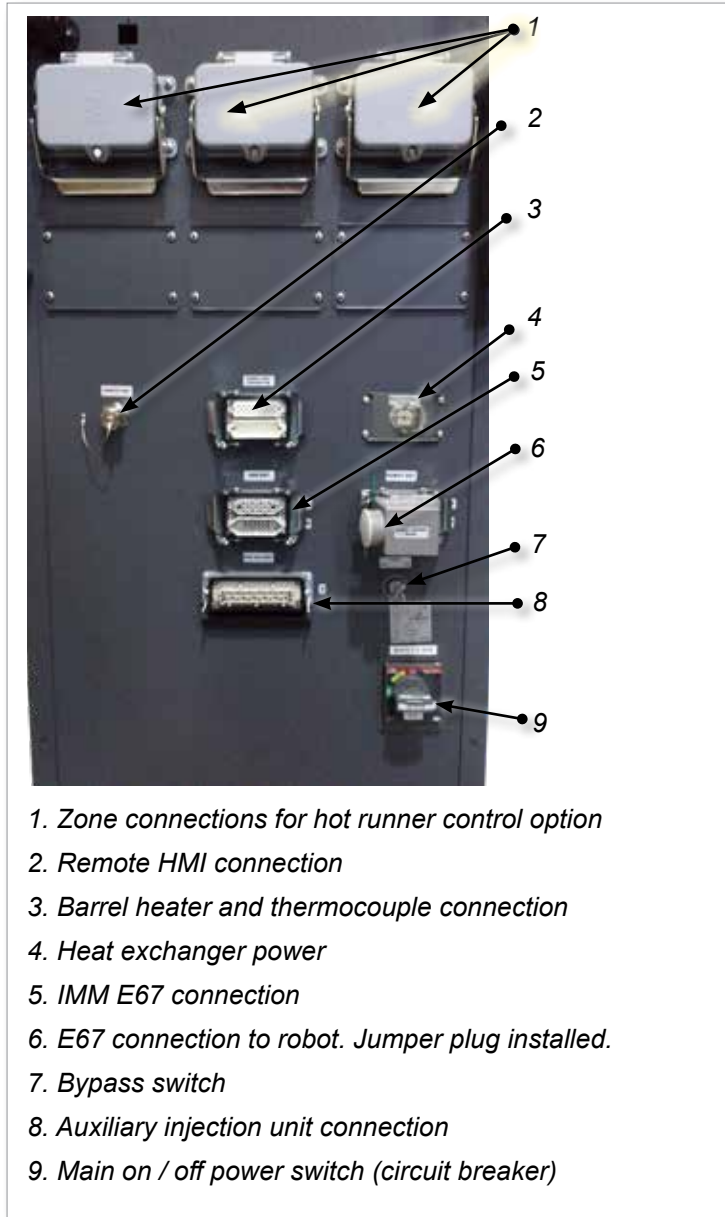

Figure 4-2 Controller back connections



Figure 4-3 Diagnostic kit (option)

4.3 Cable Holders

The E-Multi controller is supplied with cable holders. See Figure 4-4.

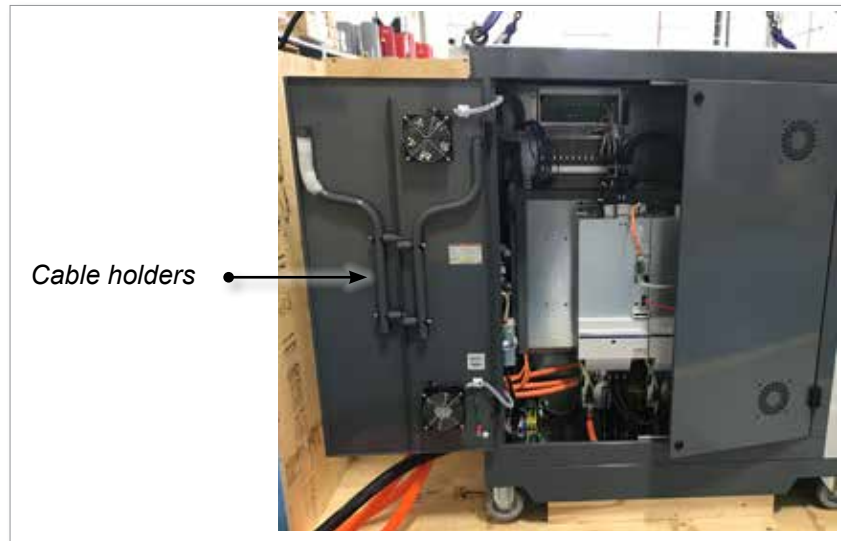

Figure 4-4 Cable holders

They can be attached to the back of the cabinet to use for cable storage. See Figure 4-5.

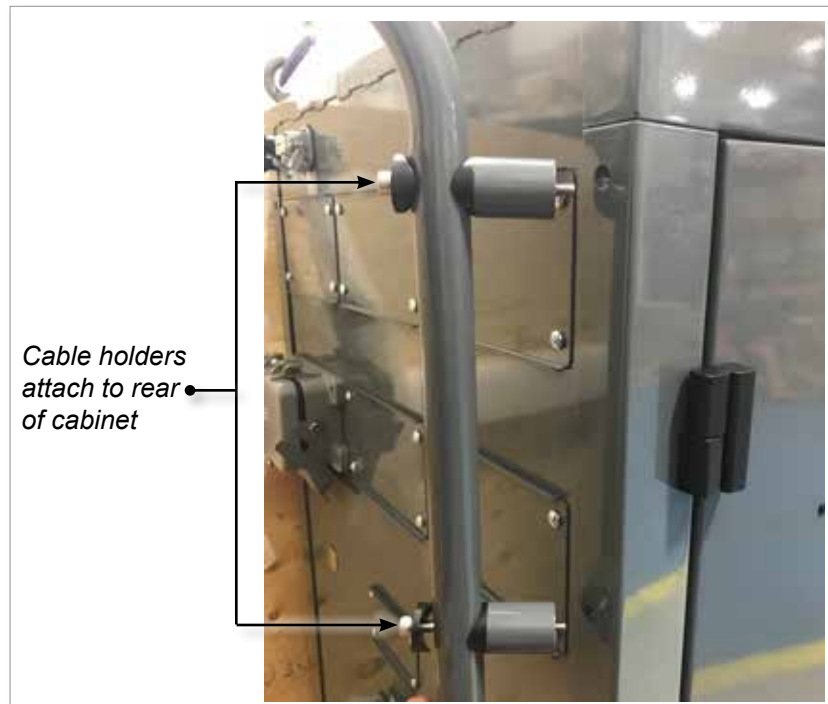

Figure 4-5 Attach cable holders

Section 5 - Installation

5.1 Introduction



WARNING

Ensure that you have fully read “Section 3 - Safety” before connecting or operating the controller.

It is the responsibility of the integrator to understand and follow international and local standards for safety of machinery when integrating the controller with the molding system.

The E-Multi controller should be located in such a way that the main disconnect is easily accessible in case of emergency.

The E-Multi controller is shipped with a power cable which is a correct size to run the system. When you install a connector on the cable, ensure that the connector can safely withstand the full system load.

The E-Multi controller supply should have a fused disconnect or main circuit breaker according to local safety codes. Refer to the serial plate on the controller cabinet for confirmation of the supply requirements. If the local supply is outside the specified range, please contact *Mold-Masters* for advice.



WARNING - ELECTRICAL SHOCK HAZARD

It is crucial to comply with these warnings to minimize any personal danger.

- Ensure that all energies are properly locked out in the controller and molding machine before installation of the controller into the system.
- DO NOT enter the cabinet without first ISOLATING the supplies OR having a qualified person selecting the BYPASS SWITCH to ON, to gain live access to the controller. There are unguarded terminals inside the cabinet which may have a dangerous potential across them. Where a three-phase supply is used, this potential may be up to 600VAC.
- With the BYPASS SWITCH set to OFF opening the high power section of the controller will cause the circuit breaker to TRIP, disconnecting all power to the cabinet.
- Voltage and amperage cables are connected to the controller and the mold. There is also a voltage cable connection between the servo motor and the controller. Electric power must be shut off and lockout / tagout procedures followed prior to installing or removing any cables.
- Integration should be done by properly trained personnel based on local codes and regulations. Electrical products may not be grounded when removed from the assembled or normal operating condition.
- Do not mix electrical power cables with thermocouple extension cables. They are not designed to carry the power load or list accurate temperature readings in each other’s application.



WARNING - TRIP HAZARD

The integrator should ensure that the controller cables do not present a trip hazard on the floor between the controller and press or the E-Multi.

5.2 Connect the Controller to the E-Multi

There are 3 sets of cables that connect the controller to the E-Multi:

1. servo power cables
2. servo feedback cables
3. heater - I/O - IMM cables



Figure 5-1 EM3 servo cable routing

The correct sequence must be followed when installing the cables. The servo power and feedback cables need to be routed through the cable track before being connected to the motors. The heater and the I/O cables can be connected directly and are not routed through the cable track. All cables should be routed so they do not interfere with the mold or molding machine operation.

5.3 Connect a Robot to the Controller

E-Multi units are compatible with both E67 and SPI robots. In all cases, the controller is shipped with a robot jumper plug.

If no robot is used, connect the robot jumper plug to the ROBOT E67 connector on the controller.

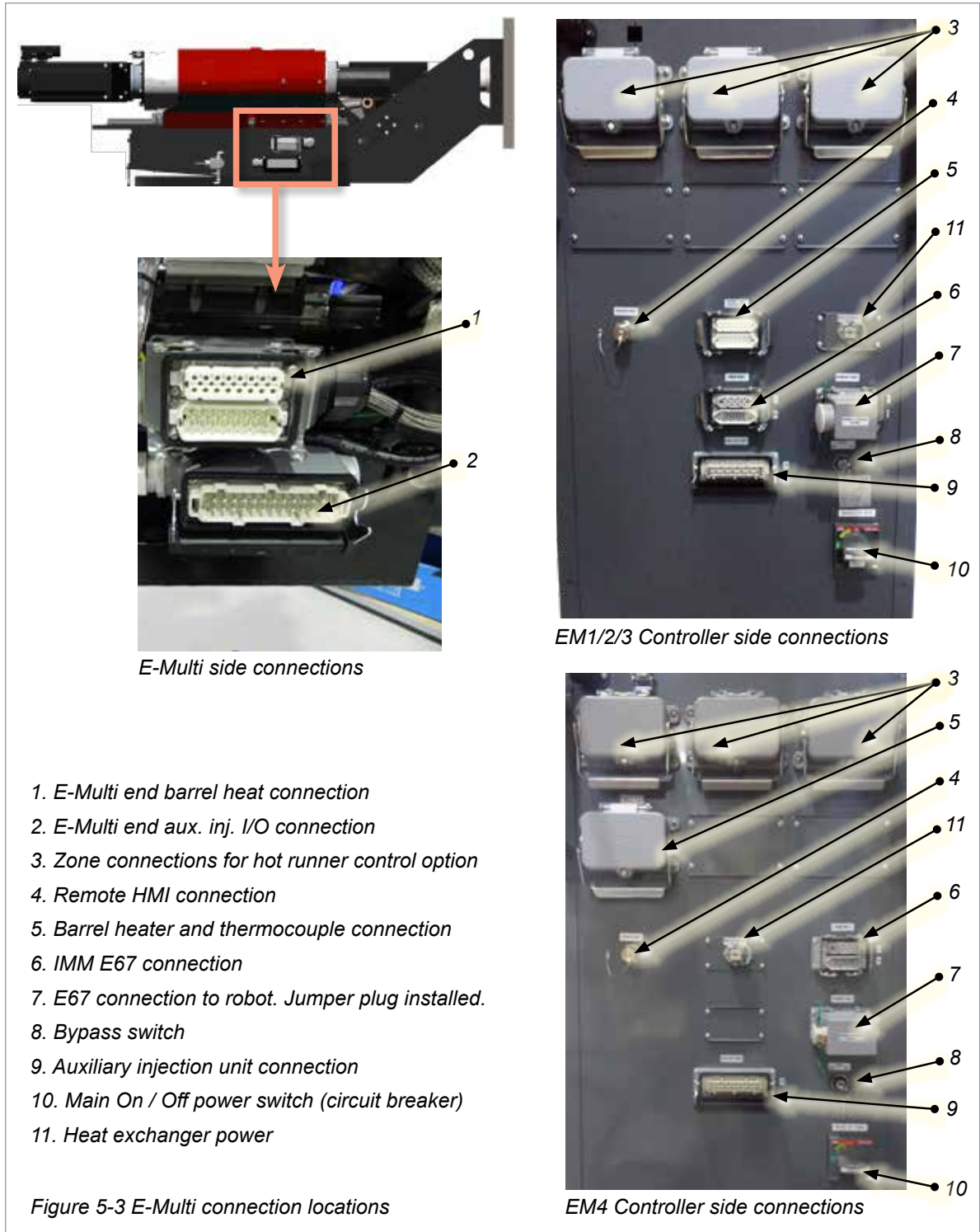

Figure 5-2 Robot jumper plug

If an E67 robot is to be used, connect the robot's E67 cable to the ROBOT E67 connector on the controller. If an SPI robot is to be used, attach the optional ROBOT SPI ADAPTER to the ROBOT E67 connector on the controller, and connect the robot's SPI cable into the ROBOT SPI ADAPTER.

5.4 Connect the Controller to the Molding Machine

E-Multi units are compatible with both E67 and SPI injection machines. All units ship with an IMM E67 cable. The cable connects to the IMM E67 connection on the controller. If used with an E67 IMM, the cable plugs into the IMM's E67 connection directly. If an SPI IMM is used, the cable plugs into the optional IMM SPI adapter, which then plugs into the IMM SPI connection.



5.5 Connect a Handheld HMI (Optional)

E-Multi units are available with optional handheld Human Machine Interface (HMI) units to allow control of the E-Multi when access to the controller is inconvenient. The handheld HMI connects to the HAND-HELD HMI connector on the controller.



IMPORTANT

If a handheld HMI is not connected then a jumper plug is required.



Figure 5-4 Handheld HMI and connection

5.6 Connect Diagnostic Computer (Optional)

1. Connect one end of the crossover cable to Ethernet port on the controller. The Ethernet cable can be connected with the power on.



2. Connect the other end of the crossover cable to the Ethernet port on the diagnostic computer. Note that the diagnostic computer may differ from the one shown.



Connect Diagnostic Computer (Optional) - continued

3. Connect the diagnostic computer power supply and connect to mains power. Use the included adapter for 220 V mains.
4. Power up the diagnostic computer and log in with the following credentials:
User name: emulti
Password: nopassword
5. Connect the diagnostic computer to a WIFI network with internet access. To see a list of available networks, click the wireless network icon next to the clock on the taskbar.



NOTE

The diagnostic computer must be connected to the internet using its wireless network adapter. The wired connection must be used to connect to the controller. *Mold-Masters* does not support alternate network configurations. Connection problems when using alternate configurations are not covered under warranty and may result in increased support times and additional costs.

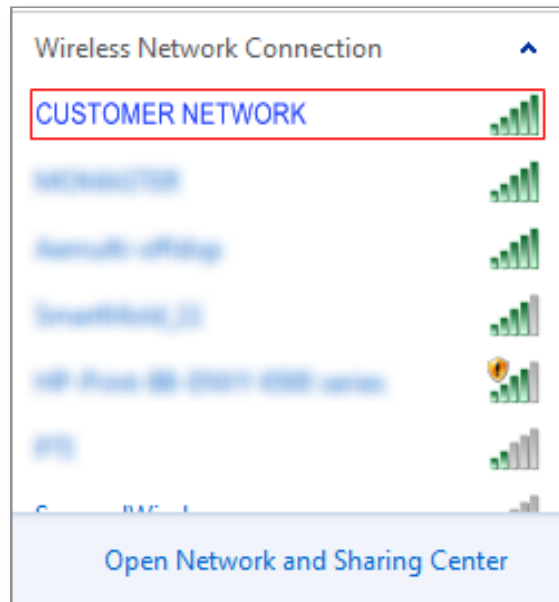

Figure 5-5 Wireless network icon

6. Open a browser and perform a search to verify internet connectivity.

Section 6 - Operation



WARNING

Ensure that you have fully read “Section 3 - Safety” before operating your E-Multi controller.



CAUTION

Although the main switch has the capacity to switch the whole system off, it is recommended that this is only done in an emergency.

The controller uses computer technology and should be switched off in stages.

A sequenced method for switching on and off protects the console and keeps the switched load to a minimum to extend the life of the main isolator.

6.1 Introduction

Before the E-Multi can be used, the controller will need to be set up. Please see Section 9 for details on setting parameters such as:

- Heating
- Control
- Injection speeds
- Trigger signals, etc.

6.2 Isolate the Controller

For all E-Multi controllers, the main power switch is a rotary circuit breaker at the rear of the cabinet. This switch is rated to safely handle the total load current during switch on and switch off.

You can use a suitably-sized padlock, or similar device to lock the switch in the off position to lockout electrical supply during maintenance.



Figure 6-1 E-Multi main power switch

6.3 Switch On

When the main power switch is turned to on, the servo motors will not be enabled.

Once the software has finished loading and the display shows the Overview page, the system is in Manual mode and is ready to have the heaters switched on to bring the barrel heaters to temperature.

Servo motors may be enabled by pressing the **[F10]** button on the button strip located below the display. Once the servo motors are enabled, the LED at the top left of the button will turn on.



Figure 6-2 Button strip below controller display (HMI)

The E-Multi controller can be used in Manual, Setup and Auto/Ready mode.

6.4 Switch Off (Shutdown)

Mold-Masters recommends that you use the console to shutdown the heating load, and only use the main current breaker switch to turn off the dormant controller.

6.4.1 Shutdown the Heating

Press the **[F8]** button located on the button strip located below the display.

The LED at the top left of the **[F8]** button indicates heating status.

- If the LED is lit, heating is active.
- If the LED is not lit, heating is off.

6.4.2 Shutdown the Controller

Once heating has been turned off, the system may be turned off using the main switch on the back of the controller.

Section 7 - E-Multi Controller HMI Interface



WARNING

Ensure that you have fully read “Section 3 - Safety” before operating your E-Multi controller.

7.1 Introduction



CAUTION

Values on the screen pictures in this manual may not reflect the correct values for your machine. *Do not change settings based on the screen pictures.*

This part of the manual describes the touchscreen interface or Human Machine Interface (HMI) and shows what functions and information are available.

From the various screens you will be able to:

- Set individual nozzle temperatures. Set high and low temperature limits for closed loop zone control.
- Configure and calibrate nozzle position and contact force.
- Create mold specific setups (recipes). These can be stored and called up when molds are changed.
- Configure the injection sequence and monitor it.
- Configure the hold sequence and monitor it.
- Configure the plasticize sequence and monitor it.
- Use the software oscilloscope (SWO) functionality to monitor operation.
- Control the password protection on all settings.
- Print out any displays or data listings.
- Connect and monitor Euromap connection between the E-Multi, molding machine and robot.

7.2 Cabinet Mounted Control Buttons

The cabinet mounted buttons are provided for quick access to commonly used functions.

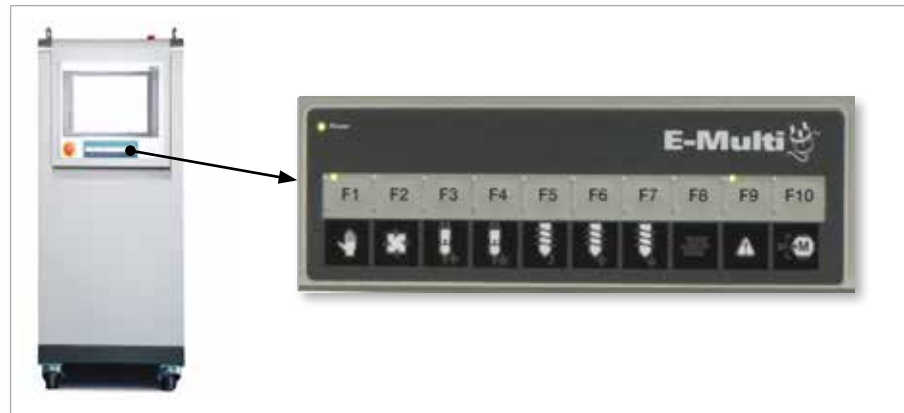

Figure 7-1 Cabinet mounted control buttons

Table 7-1 Control Buttons			
	<p>F1 Manual/Setup Mode E-Multi will not be controlled by the molding machine in this mode. This mode is used for setup functions and jogging motors.</p>		<p>F2 Ready / Auto Mode E-Multi will be triggered by the molding machine depending on the E-Multi triggering method selected.</p>
	<p>F3 Carriage Move Retract The carriage can be retracted by placing the E-Multi in Manual / Setup mode and pressing this button.</p>		<p>F4 Carriage Move Advance The carriage can be advanced by placing the E-Multi in Manual / Setup mode and pressing this button.</p>
	<p>F5 Screw Rotate The screw can be rotated by placing the E-Multi in Manual / Setup mode and pressing this button. The screw will rotate until you press this button again to turn it off.</p>		<p>F6 Screw Retract The screw can be retracted by placing the E-Multi in Manual / Setup mode and pressing this button.</p>
	<p>F7 Screw Advance The screw can be advanced by placing the E-Multi in Manual / Setup mode and pressing this button.</p>		<p>F8 Nozzle Heaters The nozzle heaters can be turned off / on at any time with this button. Note: If the heater temperature is outside the preset limits, the E-Multi will not operate and an error will be displayed.</p>
	<p>F9 Acknowledge/Reset current alarms Any current alarms will be acknowledged and a reset will be attempted when this button is pressed.</p>		<p>F10 Enable Servo Motors The injection and screw servo axis motor control is enabled by pressing this button. The LED on the top left corner of this button will light up when the drives are enabled. No motion will occur if this button is not lit up.</p>

7.3 E-Multi Touchscreen Interface

The E-Multi is a complex controller but the main screen is organized to simplify navigation and to show those parameters which are most useful to monitor. The main parts of the screen are shown here below.

Main Screen

The main screen area may display information, have fields for entering or displaying information and have touch sensitive areas to select or deselect options.

Top Bar - Status Display

This area displays current live status for screw position, screw revolution and injection pressure. It also displays the current user and user level.

Bottom Bar - Screen Navigation Buttons

The bottom bar navigates to the main HMI screens: Overview, Valve Gate Settings, Injection Settings, Hold Settings, Recovery Settings, etc.

Right Bar - Context Menu Buttons

This bar displays system information at the top and touch buttons below that give quick access to commonly used functions. Some buttons will be screen specific.

Active Movement Icons

Status Icons

Heater on / off, Motor on / off, etc.

7.3.1 Top Bar - Status Display

The status display is located at the top of the screen and is always shown. The status display has 5 boxes of information:

Table 7-2 Top Bar - Status Display	
	<p>Print Command Useful to obtain a screen picture or printed record of production information and settings, or for communicating with service people.</p>
	<p>Warning / Error Status Messages If an alarm occurs, this box shows red with a description of the alarm. If two or more alarms occur, they are counted at the right hand side. Six alarms are shown in this example. To see all active alarms tap the red message bar or the [Alarm] button.</p>
	<p>Current Live Status Live status on screw speed and position and injection pressure.</p>
	<p>User Level Shows current user and current user access level.</p>
	<p>Mode and Status Window Shows what systems are active, their status and if any alarms are present.</p>



7.3.2 Active Movement Icons

These icons are displayed above the side bar while the E-Multi is running. These icons give the user valuable information on the current status of the E-Multi. If the icon is green, it is active. If the icon is greyed out, it is inactive.

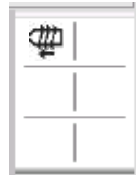

Table 7-3 Active Movement Icons	
	Screw injecting
	Screw holding
	Screw rotating (plasticizing)
	Screw moving backward
	Screw moving forward
	Carriage moving forward
	Carriage moving backward

7.3.3 Status Icons

These icons display the current machine operation status.















Table 7-4 Status Icons		
	Barrel Heat Status - grey (shown) when barrel heaters are off and green when barrel heaters are on. Same as [F8] button LED.	
	Servo Motor Active - grey (shown) when servo motors are off and green if on	
	Mode Indicator - An icon indicating the current machine mode	
		Manual Mode. Machine jogs at full speed.
		Set up Mode. Machine jogs at set up speed.
	Automatic Mode. Machine will operate automatically when the molding machine provides the proper trigger and the EuroMap connections from the molding machine and robot are correct.	

7.3.4 Bottom Bar - Screen Navigation Buttons

The Screen Navigation buttons at the bottom of the screen are used to navigate to the main HMI screens.



Table 7-5 Screen Navigation Buttons	
	<p>Overview (Home) Screen This screen is the 'home page' for the system. It provides an overview of the operation of the E-Multi.</p>
	<p>Injection Settings Screen This screen is used to adjust settings for the injection phase of the E-Multi injection molding cycle.</p>
	<p>Hold Settings Screen This screen is used to adjust the settings for the hold phase of the E-Multi injection molding cycle.</p>
	<p>Recovery Settings Screen This screen is used to adjust the settings for the recovery or plasticize phase of the E-Multi injection cycle.</p>
	<p>Barrel Temperature Settings Screen This screen is used to adjust the settings for the E-Multi barrel heaters.</p>
	<p>Hot Runner Temperature Control Screen This screen is used to adjust parameters for hot runner temperature control, for systems with this integrated option. If the option is not available then the button will be greyed out as shown above.</p>
	<p>E-Drive Screen This screen is used to adjust E-Drive parameters, for systems with an integrated E-Drive. If the option is not available then the button will be greyed out.</p>
	<p>Valve Gate Screen This screen is used to adjust the behavior of the digital valve gate trigger outputs.</p>
	<p>Production Graph Screen The Production Graph screen is used to display real time production information based on preset system variables.</p>
	<p>Machine Specification (Service Overview) Screen This screen serves as a central access point for all configuration screens as well as service and maintenance screens.</p>
	<p>Alarm Display Takes the user to the alarm screen which displays a list of alarms triggered by the control system.</p>
	<p>Back Button Returns to the screen that was previously displayed.</p>

7.3.5 Print Functionality

Before moving into the screen descriptions it is useful to know how to capture or print screens. This is often used by production personnel to obtain a printed record of production information and settings or for communicating with service people.

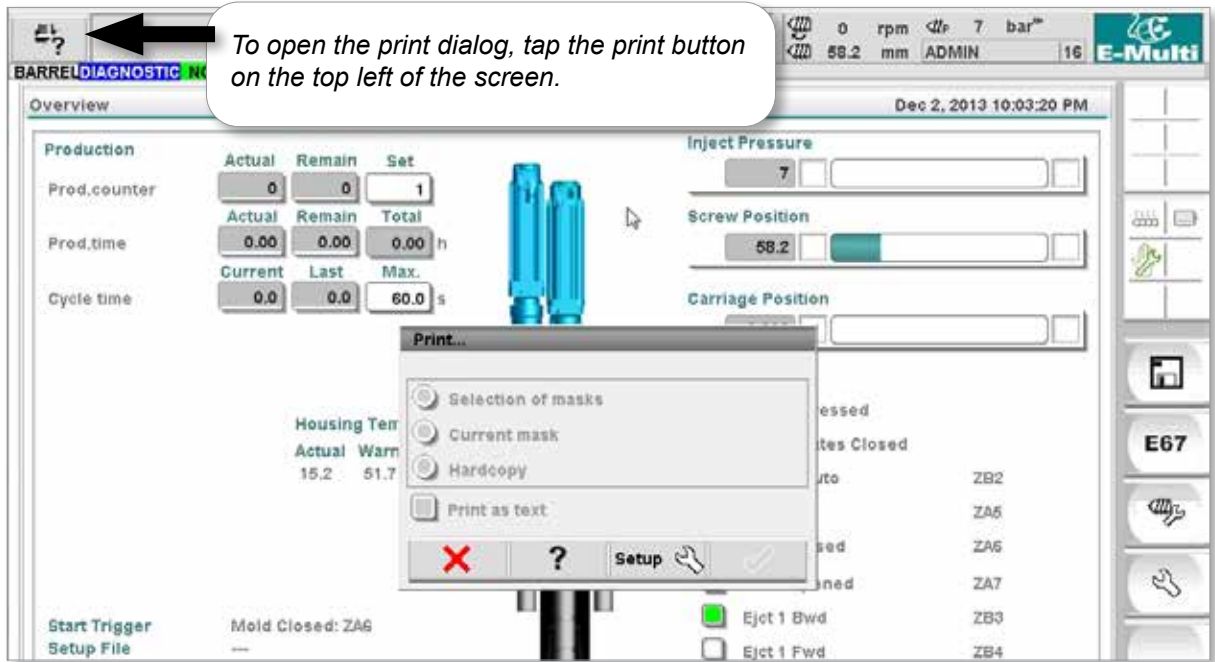















Figure 7-2 Print functionality screen

When the Print Setup button is tapped, the printer setup dialog will appear. The printer settings are described below.

Table 7-6 Printer Settings		
Screen Element		Description
	Use Printer	Output to a USB printer.
	Print to File	Output to a file.
	MIME Type	Selection of a MIME-type for the output file.
	Directory	Target directory for the output file.
	Filename	File name of the output file.

7.4 Screen Descriptions

In this user manual, screen descriptions are presented in the order of the lower screen navigation buttons. Some screens required a description of many subsidiary screens which are indicated with an arrow (→) under the parent screen. Many screens can also be accessed using the context buttons on the right of a screen.

-  Overview (Home) Screen
-  Injection Settings Screen
-  Hold Settings Screen
-  Recovery Settings Screen
-  Barrel Temperature Settings Screen
-  Hot Runner Temperature Control Screen (Option)
 - Monitor Screen
 - Setup Screen (Supervisor Level)
 - Utilities Screen (Supervisor Level)
-  E-Drive Screen (Option)
 - Overview Screen
 - Settings Screen (Supervisor Level)
-  Valve Gate Screen
-  Production Graph Screen
 - Setup → Configuration Details
- Process Data (PD) Protocol Screen**
-  Main Screen
 - System Settings
 - Carriage
 - Info-Log
 - Production Graph
 - Programmable I/O
 - I/O Monitor
 - Production Settings
 - Drive Manager
 - Task Monitor
 - Profile Settings
 - Drive Parameter Monitor
 - PID Settings
 - Machine Data
 - Variable Monitor
 - Delay Settings
 - Calibration Settings
-  Alarm Display
-  Mold Data Screen
-  Euromap 67 Screen

7.5 Overview Screen

This screen serves as a standard display in ongoing production operation and provides operating personnel with an overview of the machine's key data.

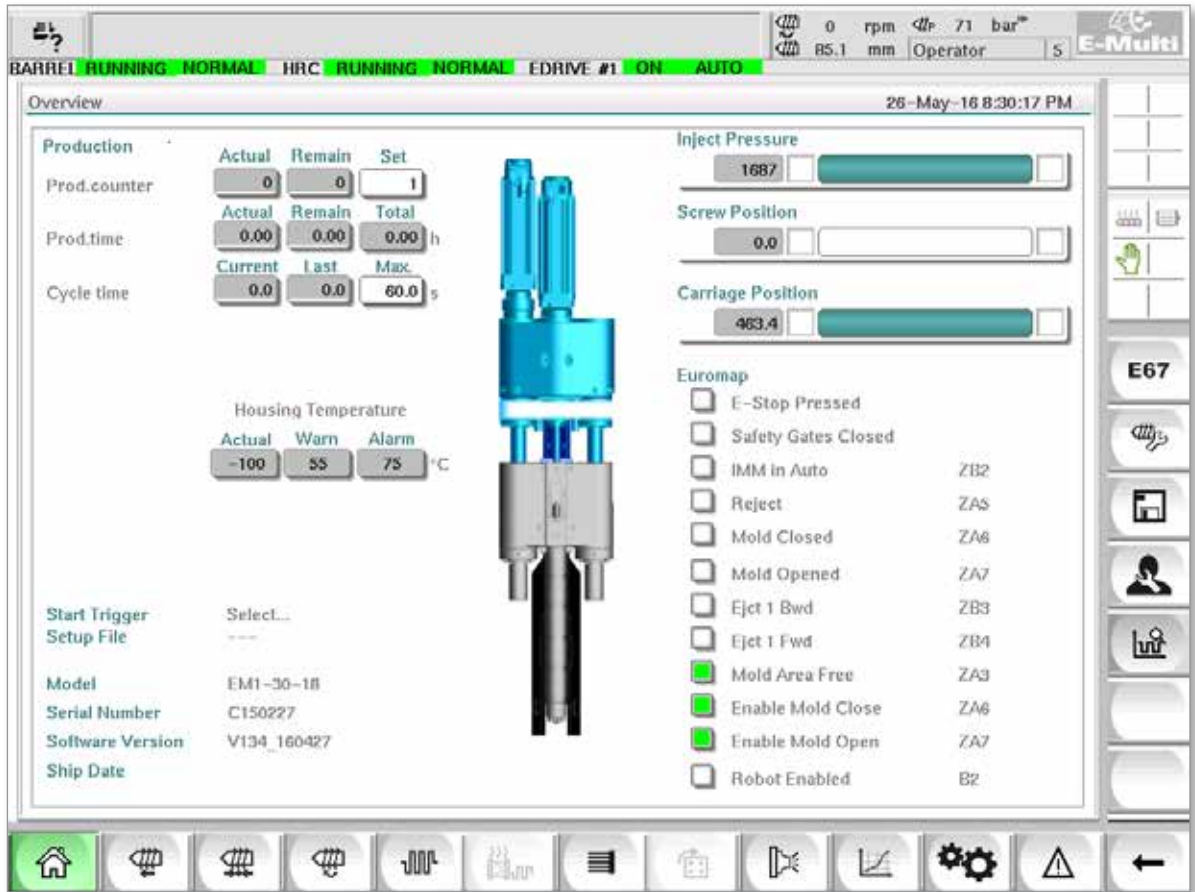
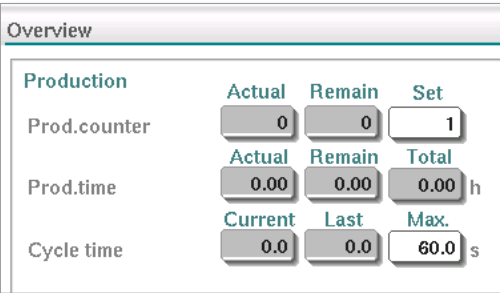
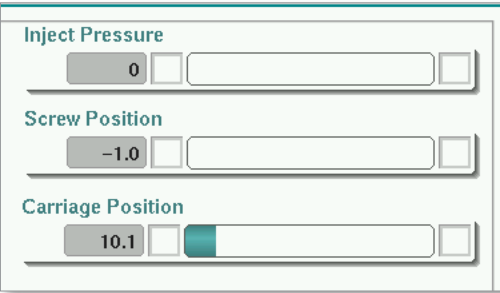





Figure 7-3 Overview screen





Overview Screen - continued

Table 7-7 Overview Screen Components	
Screen Components	Description
	<p>Live E-Multi Production Values at the top of the screen provides the operating personnel with an overview of production data:</p>
	<p>Prod. counter</p> <p>The current number of shots (shot counter) is shown in the Actual field. The remaining number of shots is shown in the Remain field. The total number of shots to be produced can be specified in the Set field.</p>
	<p>Prod. time</p> <p>The current production time is shown in the Actual field. The remaining production time is shown in the Remain field. The total production time is shown in the Total field.</p>
	<p>Cycle time</p> <p>The current cycle time is shown in the left field (grey). The last cycle time is shown in the middle field (grey). The maximum cycle time is shown in the right field (white).</p>
	<p>Injection Pressure</p> <p>When machine is idle, this shows the system preload pressure. When an injection cycle is active, this shows the plastic pressure generated by the injection unit. An analog bar shows the current position graphically. Markers to the left and right of the analog bar indicate when the end position is reached.</p>
	<p>Screw Position</p> <p>Current position of the E-Multi screw, relative to the fully forward reference position. An analog bar shows the current position graphically. Markers to the left and right of the analog bar indicate when the end position is reached.</p>
	<p>Carriage Position</p> <p>The position of the carriage relative to the nozzle touch point (fully forward). An analog bar shows the current position graphically. Markers to the left and right of the analog bar indicate when the end position is reached.</p>

Overview Screen - continued

Table 7-7 Overview Screen Components	
Screen Components	Description
	<p>Live E-Multi Barrel Housing Temperature This section displays the actual and set point values for the Housing Temperature. The housing color will change to orange if the warning temperature is exceeded and red if the alarm temperature is exceeded.</p>
	<p>Sequence Start / Trigger This section displays the current start trigger settings. The settings may be changed on the Euomap 67 screen.</p> <p>Trigger: This is the Euomap I/O signal from the molding machine that starts the E-Multi process.</p> <p>Start Delay Time: When the Euomap signal is detected, this time delay is added before the E-Multi process starts. Set to zero to disable.</p> <p>Start Delay Count: At the start of the mold run only, the chosen number of injection molding machine cycles will automatically run before the E-Multi injection process starts.</p> <p>Setup File Shows the current software version.</p>
	<p>System Information This section displays information specific to the E-Multi system. When requesting service, provide this information to the <i>Mold-Masters</i> representative.</p>
	<p>Euomap This screen area provides a quick overview of the live status of the Euomap signals. The box is either green if the input or output is on, or white (empty) if the input or output is off.</p> <p>Green - signal is logical true Empty - signal is logical false</p>

Overview Screen - continued

Table 7-8 Overview Screen Context Menu Buttons	
	<p>Mold Data Navigates to the Mold Settings Screen where mold data may be saved and loaded for each specific mold. See “Mold Data Screen” on page 7-89</p>
	<p>Euromap 67 Navigates to the EuroMap 67 screen which allows the user to monitor communications between the E-Multi and the injection molding machine. See “Euromap E67 Screen” on page 7-91.</p>
	<p>Reference Settings Navigates to the Reference Settings screen where carriage reference position, screw reference position and injection pressure reference may be set or reset.</p>
	<p>System Settings Navigates to the System Settings Screen where screen saver options and global settings like language, date and time, units can be adjusted. This screen also displays system information like current user, software version, and IP addresses. See “System Settings Screen” on page 7-62.</p>

7.6 Injection Settings Screen

This screen is used to adjust screw movement settings during injection. It is also used to adjust the transition point, at which the system changes from injection to hold pressure.

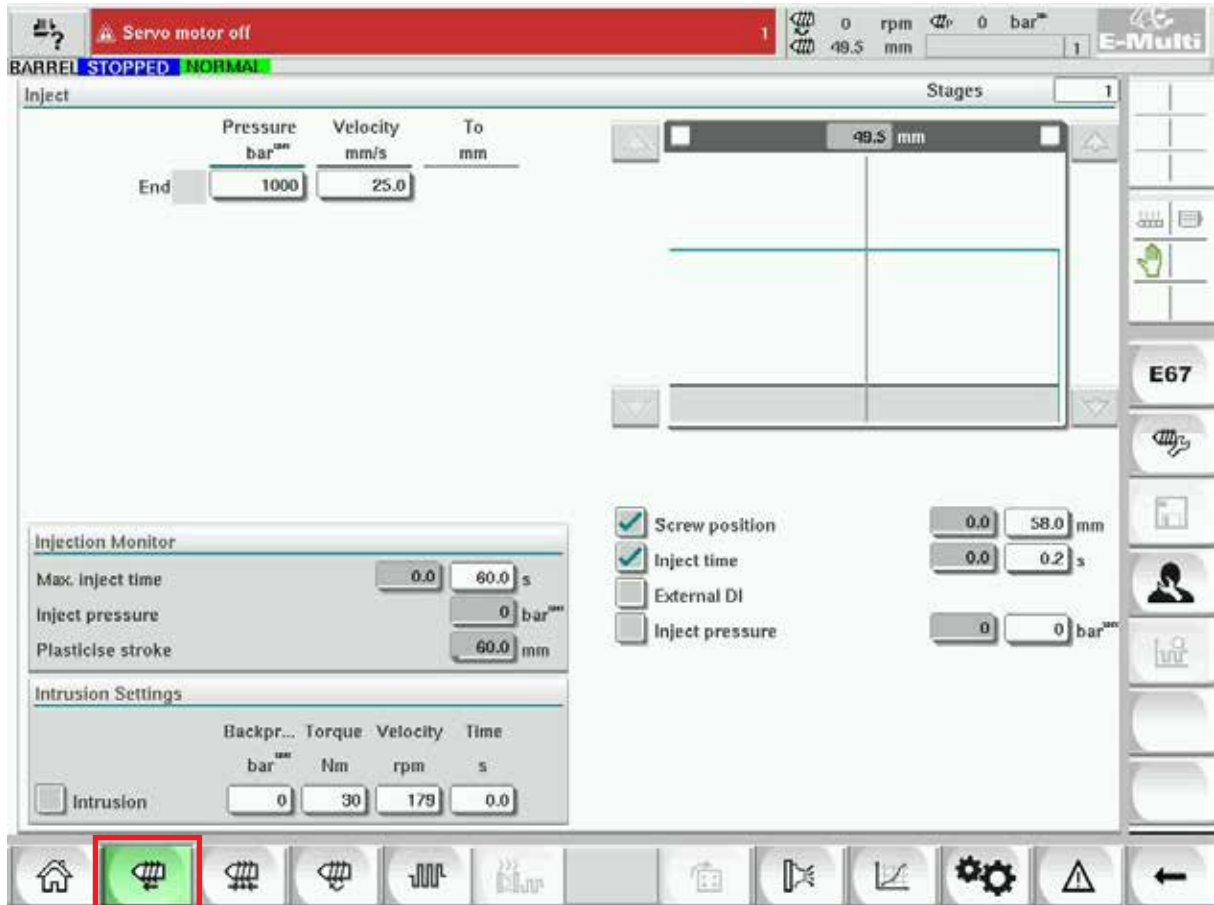

Figure 7-4 Injection settings screen

Table 7-9 Injection Settings Screen Components	
Screen Components	Description
	<p>Inject</p> <p>This section displays the current injection profile. The profile is displayed numerically in the fields on the left and graphically on the right. The number of injection steps may be adjusted using the stages field at the top left. A maximum of 10 steps may be selected.</p>
	<p>Pressure and Velocity Input Fields</p> <p>These settings can be adjusted by entering values directly into these fields. These fields are used for setting the Pressure and Velocity between the end position of the previous stage (in case of stage 1, the end position of the previous part movement) and the position specified under the 'To' column. The last step will complete when one of the transition conditions is met.</p>

Injection Settings Screen - continued

Table 7-9 Injection Settings Screen Components											
Screen Components	Description										
	<p>Pressure and Velocity Input Graph Alternatively, the <i>Pressure</i> (teal) and the <i>Velocity</i> (grey) values are shown in the form of profile graphs and the values can be adjusted using the arrow keys next to the profile graphs. On each tap of the arrow, the profile graph is adjusted by +/-5 bar and/or +/-5%.</p>										
	<p>Transition Conditions Used to set the conditions when the system changes from injection to the hold. If multiple conditions are selected, the change will occur when the first condition is met. Activate conditions by checking the box to the left of the field label.</p> <table border="1"> <tr> <td>Screw position</td> <td>Specifies the screw position at which the system changes to hold pressure.</td> </tr> <tr> <td>Inject time</td> <td>Specifies the number of seconds after which the system changes to hold pressure (measured from the start of the injection process).</td> </tr> <tr> <td>Inject pressure</td> <td>Specifies the injection pressure at which the system changes to hold pressure.</td> </tr> <tr> <td>External DI</td> <td>The cut off position is signaled by an external digital input. The digital input is shown on the electrical schematics and is labeled: Hold Transition (External).</td> </tr> <tr> <td>Cut Off Activation Position</td> <td>Injection pressure for transition will not be monitored until the screw position is less than this position. It is used to prevent transition when injection pressure spikes at the start of injection. Note: This field is only available when transition on injection pressure is selected.</td> </tr> </table>	Screw position	Specifies the screw position at which the system changes to hold pressure.	Inject time	Specifies the number of seconds after which the system changes to hold pressure (measured from the start of the injection process).	Inject pressure	Specifies the injection pressure at which the system changes to hold pressure.	External DI	The cut off position is signaled by an external digital input. The digital input is shown on the electrical schematics and is labeled: Hold Transition (External).	Cut Off Activation Position	Injection pressure for transition will not be monitored until the screw position is less than this position. It is used to prevent transition when injection pressure spikes at the start of injection. Note: This field is only available when transition on injection pressure is selected.
Screw position	Specifies the screw position at which the system changes to hold pressure.										
Inject time	Specifies the number of seconds after which the system changes to hold pressure (measured from the start of the injection process).										
Inject pressure	Specifies the injection pressure at which the system changes to hold pressure.										
External DI	The cut off position is signaled by an external digital input. The digital input is shown on the electrical schematics and is labeled: Hold Transition (External).										
Cut Off Activation Position	Injection pressure for transition will not be monitored until the screw position is less than this position. It is used to prevent transition when injection pressure spikes at the start of injection. Note: This field is only available when transition on injection pressure is selected.										

Injection Settings Screen - continued

Table 7-9 Injection Settings Screen Components	
Screen Components	Description
	<p>Inject pressure: Displays the current Injection pressure.</p> <p>Plasticize stroke: Displays the current plasticize stroke. The plasticize stroke is the value of the last plasticizing stage plus the position value of 'Decompression after plasticize' in the plasticizing screen.</p>
	<p>Max. inject time: The left field displays the inject time of the current cycle. In the right field, the maximum inject time (without delay time) can be set. If this time is exceeded an alarm will be raised and the cycle will be stopped.</p>
	<p>Intrusion: The fields to the right will be used for setting Pressure, Velocity and Time for the intrusion (screw rotation before Inject).</p>

Table 7-10 Injection Settings Screen Context Menu Buttons	
	<p>Motor or Drive Information Screen</p>
	<p>Production Graph - Configurable View</p>
	<p>Production Settings</p>
	<p>Reference Settings</p>

7.7 Hold Settings Screen



CAUTION

Recovery back pressure should never be adjusted below the idle (preload) pressure.

This screen is used for adjusting hold pressure settings.

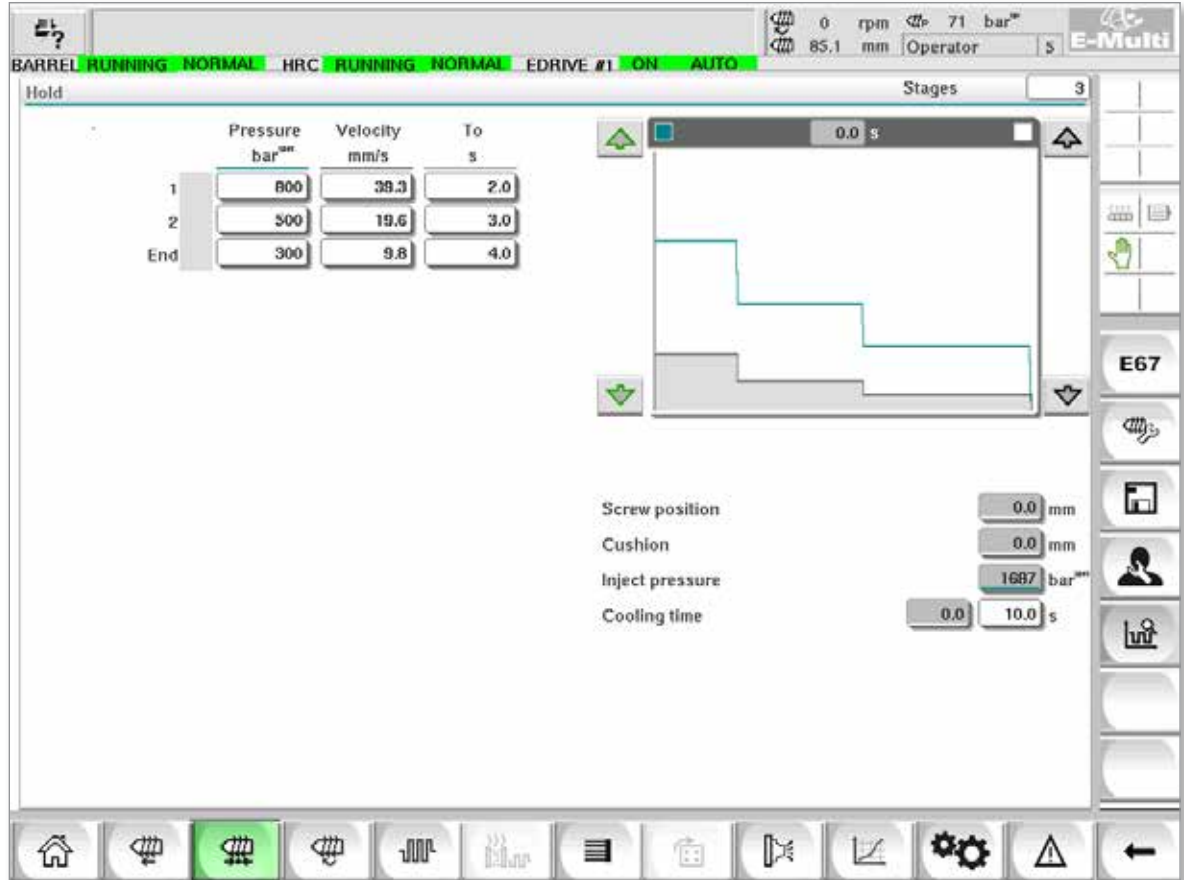

Figure 7-5 Hold settings screen

Table 7-11 Hold Setting Screen Components

Screen Components	Description																
	<p>Hold</p> <p>This section displays the current hold profile. The profile is displayed numerically in the fields on the left and graphically on the right. The number of hold steps may be adjusted using the Stages field at the top left. A maximum of 10 steps may be selected.</p>																
<table border="1"> <thead> <tr> <th></th> <th>Pressure bar^{mm}</th> <th>Velocity mm/s</th> <th>To s</th> </tr> </thead> <tbody> <tr> <td>1</td> <td>800</td> <td>4.2</td> <td>2.0</td> </tr> <tr> <td>2</td> <td>500</td> <td></td> <td>3.0</td> </tr> <tr> <td>End</td> <td>300</td> <td></td> <td>4.0</td> </tr> </tbody> </table>		Pressure bar ^{mm}	Velocity mm/s	To s	1	800	4.2	2.0	2	500		3.0	End	300		4.0	<p>Pressure and Velocity Input Fields</p> <p>These settings can be adjusted by entering values directly into these fields. These fields are used for setting the Pressure and Velocity between the end position of the previous stage (in case of stage 1, the end position of the previous part movement) and the position specified under the 'To' column.</p>
	Pressure bar ^{mm}	Velocity mm/s	To s														
1	800	4.2	2.0														
2	500		3.0														
End	300		4.0														

Hold Settings Screen - continued

Table 7-11 Hold Setting Screen Components							
Screen Components	Description						
	<p>Pressure and Velocity Input Graph Alternatively, the <i>Pressure</i> (teal) and the <i>Velocity</i> (grey) values are shown in the form of profile graphs and the values can be adjusted using the arrow keys next to the profile graphs. On each click of the arrow, the profile graph is adjusted by +/-5 bar and/or +/-5%.</p>						
	<p>Data Display This area of the screen displays current pressure and screw position information.</p> <table border="1"> <tr> <td>Screw position</td> <td>Maximum screw forward position at the end of hold.</td> </tr> <tr> <td>Cushion</td> <td>Display of melt cushion at the end of injection.</td> </tr> <tr> <td>Inject pressure</td> <td>Displays the current injection pressure.</td> </tr> </table>	Screw position	Maximum screw forward position at the end of hold.	Cushion	Display of melt cushion at the end of injection.	Inject pressure	Displays the current injection pressure.
Screw position	Maximum screw forward position at the end of hold.						
Cushion	Display of melt cushion at the end of injection.						
Inject pressure	Displays the current injection pressure.						
	<p>Cooling Time The current cooling time (actual value) is shown in the left field (grey). The cooling time (set point) may be entered into the right (white) field.</p>						
	<p>Hopper On (if enabled in factory settings) This check box allows you to turn the hopper on or off.</p>						

Table 7-12 Hold Settings Screen Context Menu Buttons	
	<p>Production Graphs Navigates to the Production Graph screen which provides real time data on the current production process.</p>

7.8 Recovery Settings Screen



CAUTION

Recovery back pressure should never be adjusted below the idle (preload) pressure.

This screen is used to adjust the settings for backpressure and feed screw speed during the recovery part of the injection cycle.

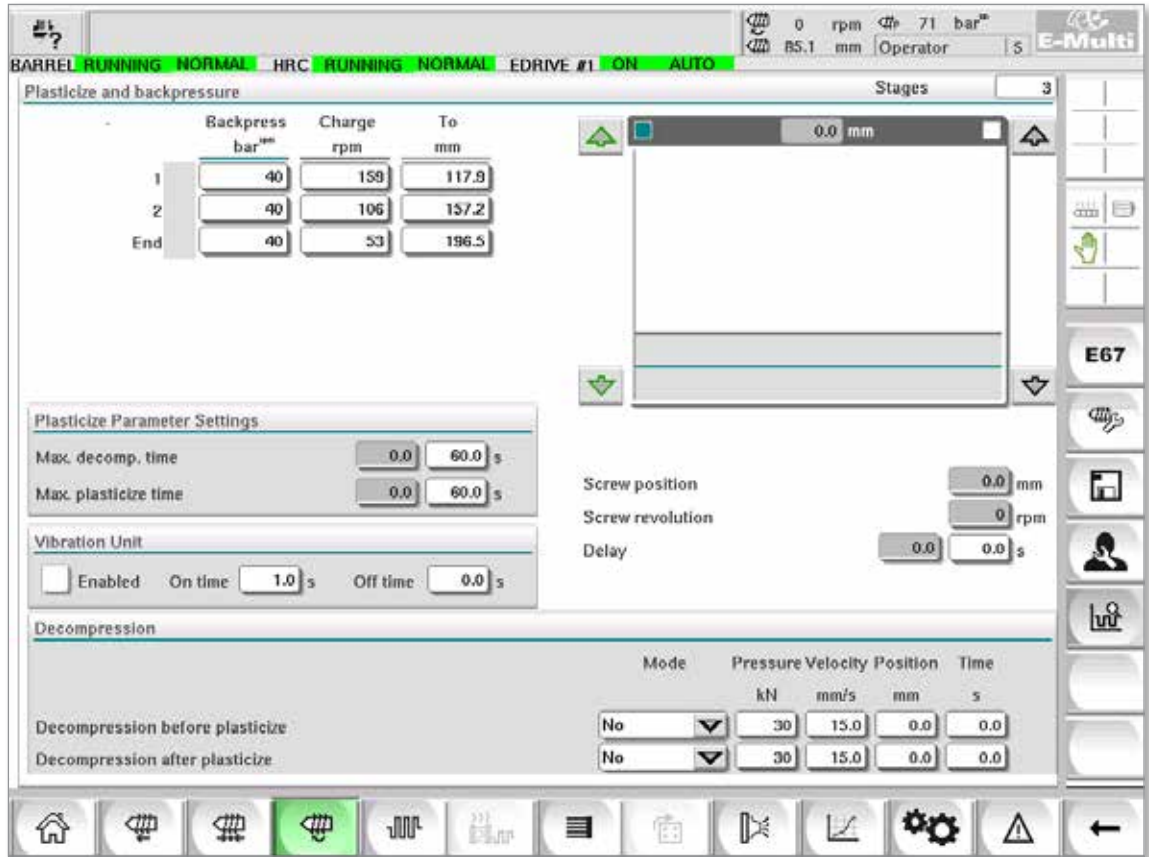
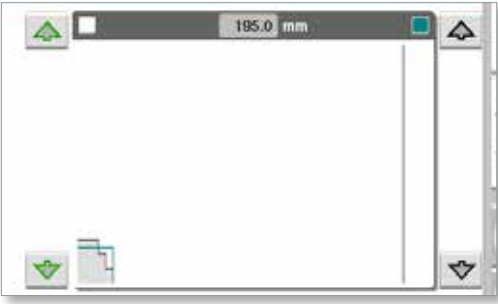

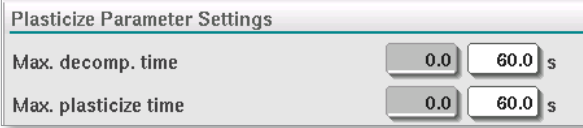



Figure 7-6 Recovery settings screen

Table 7-13 Recovery Settings Screen Components	
Screen Components	Description
	<p>Plasticize and backpressure This section displays the current recovery profile. The profile is displayed numerically in the fields on the left and graphically on the right. The number of recovery steps may be adjusted using the Stages field at the top left. A maximum of 5 steps may be selected.</p>
	<p>Backpressure and Charge Input Fields These settings can be adjusted by entering values directly into these fields. These fields are used for setting the Backpressure and Charge between the end position of the previous stage (in case of stage 1, the end position of the previous part movement) and the position specified under the 'To' column.</p>

Recovery Settings Screen - continued

Table 7-13 Recovery Settings Screen Components									
Screen Components	Description								
	<p>Backpressure and Charge Input Graph Alternatively, the Backpressure (teal) and the Charge (grey) values are shown in the form of profile graphs and the values can be adjusted using the arrow keys next to the profile graphs. On each click of the arrow, the profile graph is adjusted by +/-5 bar and/or +/-5%.</p>								
	<p>Data Display This area of the screen displays the current inject pressure and screw revolution and position. The Delay field can be adjusted - see below.</p> <table border="1"> <tr> <td>Screw position</td> <td>Displays the current screw position.</td> </tr> <tr> <td>Screw revolution</td> <td>Displays the current screw revolution.</td> </tr> <tr> <td>Charge torque</td> <td>Specifies the maximum charge torque.</td> </tr> <tr> <td>Delay</td> <td>The delay time for the start of plasticize is specified here.</td> </tr> </table>	Screw position	Displays the current screw position.	Screw revolution	Displays the current screw revolution.	Charge torque	Specifies the maximum charge torque.	Delay	The delay time for the start of plasticize is specified here.
Screw position	Displays the current screw position.								
Screw revolution	Displays the current screw revolution.								
Charge torque	Specifies the maximum charge torque.								
Delay	The delay time for the start of plasticize is specified here.								
	<p>Plasticize Parameter Settings</p> <table border="1"> <tr> <td>Max. decomp. time</td> <td>Here the maximum allowed decompression time can be set. This value is the maximum allowed value to be input on the plasticize screen.</td> </tr> <tr> <td>Max. plasticize time</td> <td>Here the maximum allowed plasticize time can be set. If the time is exceeded an alarm will be raised and the cycle will be stopped.</td> </tr> </table>	Max. decomp. time	Here the maximum allowed decompression time can be set. This value is the maximum allowed value to be input on the plasticize screen.	Max. plasticize time	Here the maximum allowed plasticize time can be set. If the time is exceeded an alarm will be raised and the cycle will be stopped.				
Max. decomp. time	Here the maximum allowed decompression time can be set. This value is the maximum allowed value to be input on the plasticize screen.								
Max. plasticize time	Here the maximum allowed plasticize time can be set. If the time is exceeded an alarm will be raised and the cycle will be stopped.								
	<p>Vibration Unit An optional vibrator may be attached to the hopper or feed tube. Vibration can be used to help the flow of material into the feed block.</p> <table border="1"> <tr> <td>Enabled</td> <td>Checking this box will enable the vibration unit. Unchecking the box will disable the vibration unit.</td> </tr> <tr> <td>On Time</td> <td>Specifies the amount of time the vibration is on within the on / off cycle.</td> </tr> <tr> <td>Off Time</td> <td>Specifies the amount of time the vibration is off within the on / off cycle.</td> </tr> </table>	Enabled	Checking this box will enable the vibration unit. Unchecking the box will disable the vibration unit.	On Time	Specifies the amount of time the vibration is on within the on / off cycle.	Off Time	Specifies the amount of time the vibration is off within the on / off cycle.		
Enabled	Checking this box will enable the vibration unit. Unchecking the box will disable the vibration unit.								
On Time	Specifies the amount of time the vibration is on within the on / off cycle.								
Off Time	Specifies the amount of time the vibration is off within the on / off cycle.								

Recovery Settings Screen - continued

Table 7-13 Recovery Settings Screen Components	
Screen Components	Description
	<p>Decompression These settings apply only for manual and automatic mode.</p>
	<p>Mode</p> <p>Mode of decompression before plasticizing, with the following selection options: No: No decompression Time: Decompression for a specified time duration Position: Decompression until a specified screw position</p>
	<p>Pressure</p> <p>Specifies the pressure for the linear screw movement. This field can only be edited when 'Time' or 'Position' mode has been selected.</p>
	<p>Velocity</p> <p>Specifies the velocity for the linear screw movement. This field can only be edited when 'Time' or 'Position' mode has been selected.</p>
	<p>Position / Time</p> <p>Specifies the screw position or the duration of the decompression. The display is dependent on the mode selected.</p>

Table 7-14 Recovery Settings Screen Context Menu Buttons	
	<p>Production Graphs Navigates to the Production Graph Screen which provides real time data on the current production process.</p>

7.9 Barrel Temperature Settings - Legacy Controllers*

This screen is used to adjust temperature settings for the barrel heating zones.



***NOTE**

These screens were available only on certain systems prior to 2015.

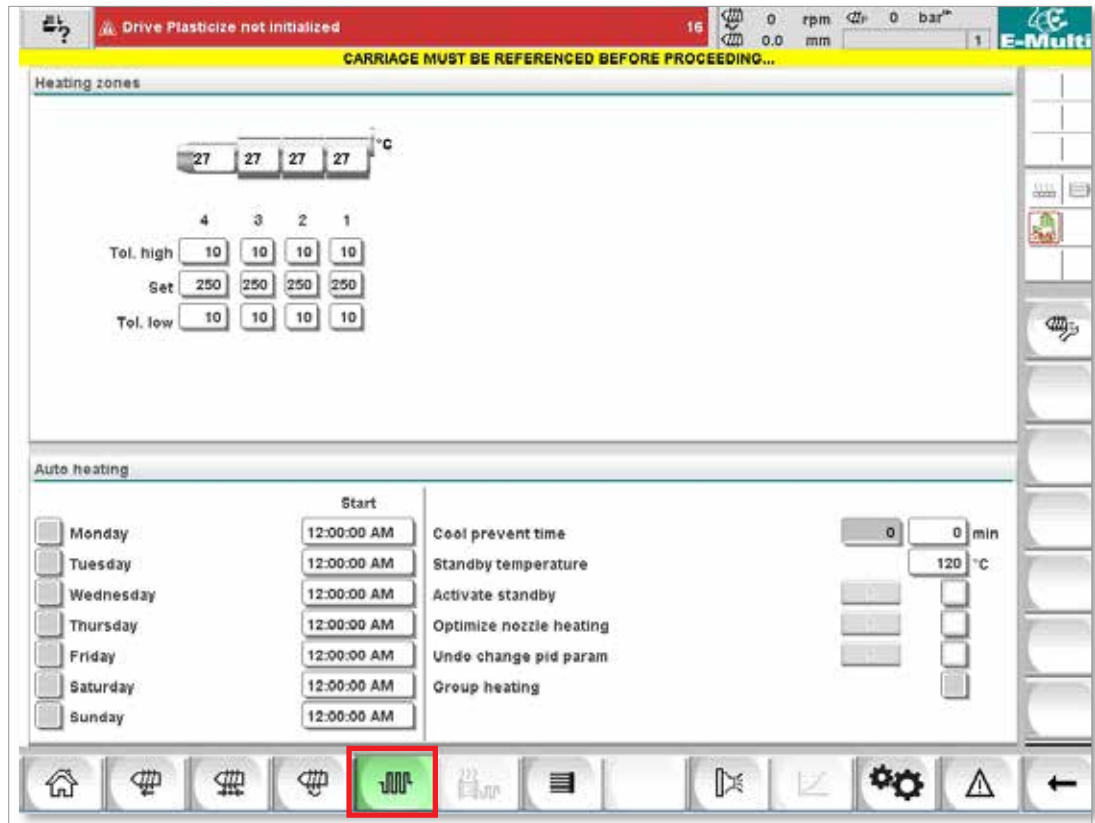

Figure 7-7 Legacy style barrel temperature settings screen

Table 7-15 Legacy Style Barrel Temperature Setting Screen Components	
Screen Component	Description
	<p>Heating zones The individual heating zones are graphically displayed with the current temperature in the middle of each zone. The display will depend on the number of heating zones.</p>
	<p>Tol. high Specifies the high tolerance within which the actual temperature of the heating zones must sit. If this tolerance is exceeded an alarm will be triggered. Only when all zones are within the tolerance is movement of the screw possible.</p>
	<p>Set Specifies the temperature set-point value of the corresponding heating zone (in degrees).</p>
	<p>Tol. low Specifies the low tolerance within which the actual temperature of the heating zones must sit. If this tolerance is exceeded an alarm will be triggered. Only when all zones are within the tolerance is movement of the screw possible.</p>

Barrel Temperature Settings - Legacy Controllers* - continued

Table 7-15 Legacy Style Barrel Temperature Setting Screen Components	
Screen Component	Description
	<p>Auto Heating Barrel heats may be switched on automatically using this feature. Check the box next to the day to enable auto heat for that day. Barrel heats will turn on at the specified time.</p> <p>Note: Heaters will stay on until manually turned off.</p>
	<p>Soak Time This is the amount of time the unit has to be at process temperature before the screw can move.</p> <p>Standby temperature Temperature setpoint when Activate Standby is checked.</p> <p>Activate standby Barrel heating is switched to standby mode. Standby temperature setpoints are used.</p> <p>Optimize nozzle heating Used to optimize heat zone PID tuning after adding a heater, replacing a heater, changing the mold or after a software update. Optimization can only be done when the barrel is cold.</p> <p>Undo change pid param Reset heater PID tuning to pre-optimization values.</p> <p>Group heating When enabled, Group Heating monitors heat zones when they are first heated to process temperature and ensures that all zones heat up at the same rate. This feature is not required for standard configurations.</p>

Table 7-16 Legacy Style Barrel Temperature Setting Screen Context Menu Buttons	
	<p>Reference Settings</p>

7.10 Barrel Temperature Settings - Mold-Masters Screen

This screen is used to adjust temperature settings for the barrel heating zones.

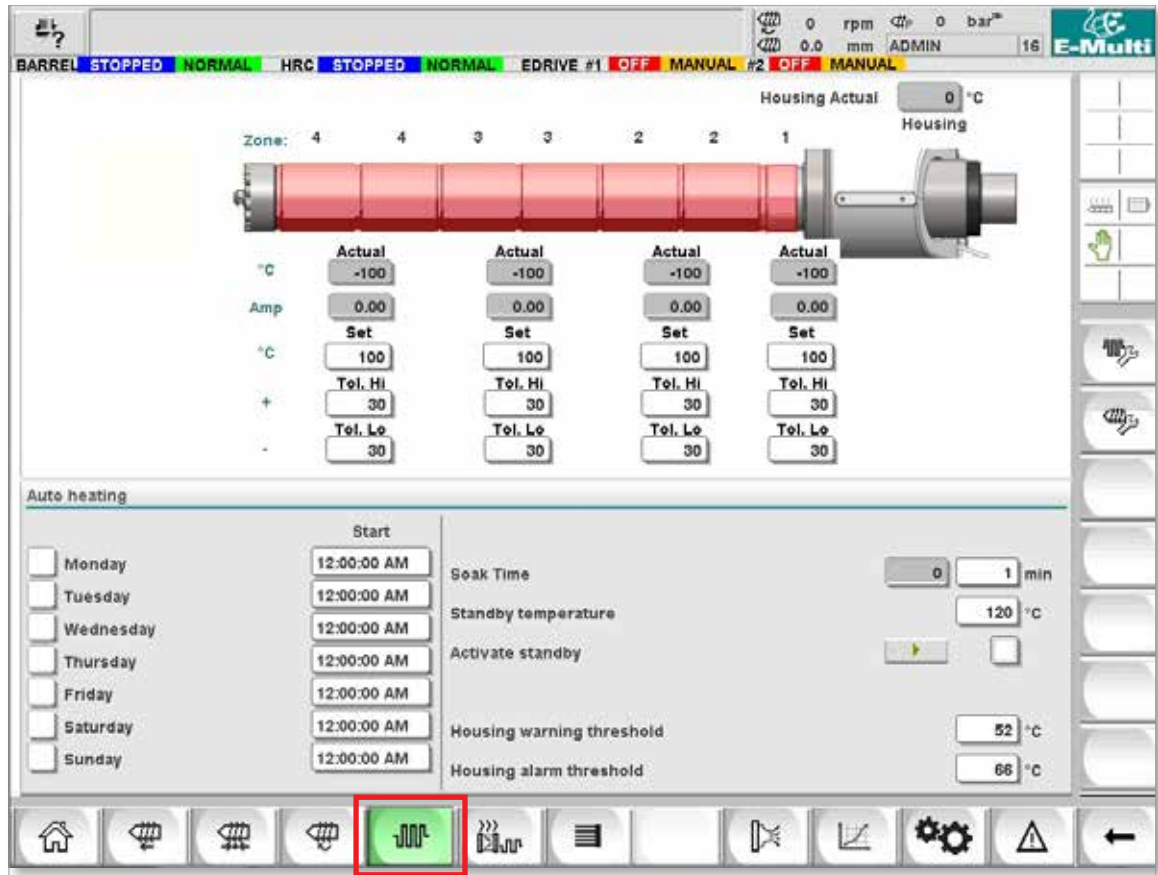

Figure 7-8 Mold-Masters barrel temperature settings screen

Barrel Temperature Settings - Mold-Masters Screen - continued

Table 7-17 <i>Mold-Masters</i> Barrel Temperature Screen Components							
Screen Component	Description						
	<p>Zone Status - Visual Display Referenced with the Top Bar Status Display for information on the current condition.</p> <p>The barrel temperature indicator zones will change color depending on the temperature of the corresponding barrel zone.</p> <p>Green - Indicates barrel zone is at operating temperature.</p> <p>Yellow - Indicates barrel zone is close to operating temperature but auto soak has not completed.</p> <p>Red - Indicates barrel is zone is outside of set temperature window.</p> <p>When AutoSoak is used, the system will wait until the barrel temperature is just below the setpoint and will attempt to turn the feed screw using low torque. If the screw can turn, the AutoSoak status will change to Pass and the color will change to green.</p> <p>When AutoSoak is not used, the system will wait until the barrel temperature is just below the setpoint and will start the soak timer. After the soak timer completes, the soak status will change to Pass and the color will change to green.</p>						
	<p>Housing Actual Actual temperature of barrel housing.</p>						
	<p>Heating Zones The individual heating zones are graphically displayed with real time temperature and current feedback displayed below each zone.</p> <table border="1" style="width: 100%; border-collapse: collapse;"> <tr> <td style="width: 15%;">Set</td> <td>Specifies the temperature set-point value of the heating zone.</td> </tr> <tr> <td>Tol Hi</td> <td>Specifies the temperature above which the zone will be out of tolerance. If the temperature exceeds this value, an alarm is triggered.</td> </tr> <tr> <td>Tol Lo</td> <td>Specifies the temperature below which the zone will be out of tolerance. If the temperature drops below this value, an alarm is triggered.</td> </tr> </table>	Set	Specifies the temperature set-point value of the heating zone.	Tol Hi	Specifies the temperature above which the zone will be out of tolerance. If the temperature exceeds this value, an alarm is triggered.	Tol Lo	Specifies the temperature below which the zone will be out of tolerance. If the temperature drops below this value, an alarm is triggered.
Set	Specifies the temperature set-point value of the heating zone.						
Tol Hi	Specifies the temperature above which the zone will be out of tolerance. If the temperature exceeds this value, an alarm is triggered.						
Tol Lo	Specifies the temperature below which the zone will be out of tolerance. If the temperature drops below this value, an alarm is triggered.						

Barrel Temperature Settings - Mold-Masters Screen - continued





Table 7-17 <i>Mold-Masters</i> Barrel Temperature Screen Components	
Screen Component	Description
	<p>Auto Heating Barrel heats may be switched on automatically using this feature. Check the box next to the day to enable auto heat for that day. Barrel heats will turn on at the specified time.</p> <p>Note: Heaters will stay on until manually turned off.</p>
	<p>AutoSoak Pass Status This indicator shows whether the AutoSoak has been successfully completed or not after all the barrel heats are up to temperature.</p> <p>Standby Temperature When Standby is activated, all barrel zone temperatures will be decreased by this amount. For example, if the barrel temperature setpoint is 200°C and the Standby setpoint is 120°C, the barrel heat will be reduced to 80°C.</p> <p>Activate Standby: Standby mode holds the heating zones at a preset temperature during a stop in production. Standby temperature is usually lower than processing temperature but higher than ambient temperature.</p> <p>On: temperature is set to the Standby temperature. No screw movement is possible.</p> <p>Off: temperature is reset to the production operating temperatures. Screw movement is possible.</p>

Table 7-18 <i>Mold-Masters</i> Temperature Settings Screen Context Menu Buttons	
	<p>Hot Runner Control Setup Screen Navigates to the Integrated Hot Runner Control Setup screen where integrated hot runner control settings can be adjusted.</p>
	<p>Reference Settings</p>

7.10.1 EM5 Barrel

The EM5 injection unit uses additional heater bands that are not present on other models. These additional heater bands are labeled Extension (EXT) A (TempZone 11) and EXT B (TempZone 12).

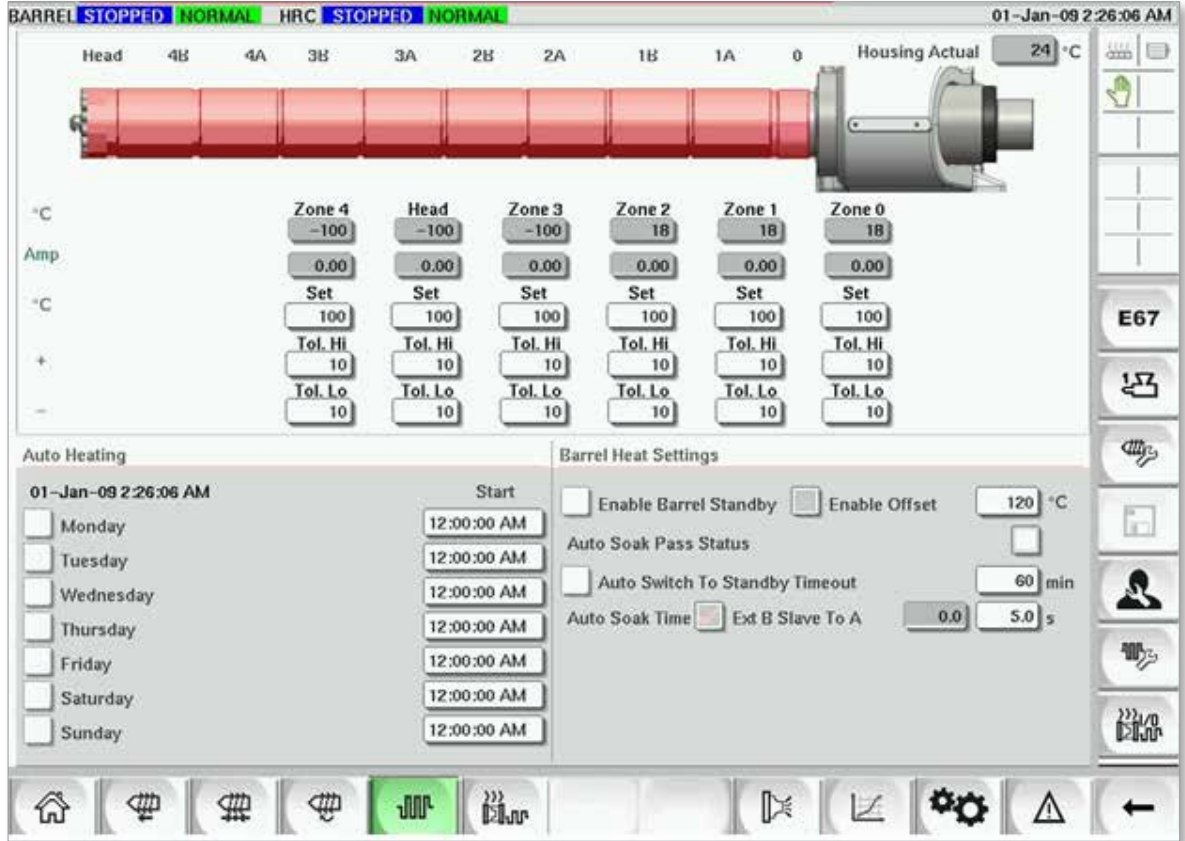

Figure 7-9 EM5 barrel-temperature settings screen

7.11 Integrated Hot Runner Temperature Control (Option)

Left Bar - Hot Runner Temperature Control Buttons

Scroll Buttons
For scrolling through the zone rows and columns

Nozzle 1	Nozzle 2	Nozzle 3	Nozzle 4	Manifold...	Manifold...	Inlet	Backplate
200°C	200°C	200°C	200°C	200°C	200°C	200°C	OFF
200°C	200°C	200°C	200°C	200°C	200°C	200°C	NZ
10% 0.1 A	9% 0.1 A	10% 0.1 A	8% 0.1 A	20% 1.2 A	21% 1.3 A	17% 0.3 A	0% 0.0 A

Supervisor Level Settings

- Hot Runner Control Setup Screen
- Hot Runner Control Utilities Screen

Lower Bar - E-Multi Screen Navigation and System Buttons

See "Bottom Bar - Screen Navigation Buttons" on page 7-6.

Figure 7-10 Integrated hot runner controller overview screen

7.11.1 Monitor Screen



WARNING

Selecting **[Stop]** does not remove voltage from the heaters. Selecting **[Stop]** sets all the target temperatures to zero. DO NOT try to change fuses or disconnect units while in this mode.

This screen is the main screen for the integrated hot runner temperature control and provides an overview of operational data.



Figure 7-11 Hot runner controller monitor screen

Table 7-19 Monitor Screen Control Buttons	
	[Run] switches on all heat zones, so that they independently rise up to their set point temperatures.
	[Stop] switches off all heat zones.

Monitor Screen - continued

Table 7-19 Monitor Screen Control Buttons	
	<p>[Standby] This mode is used when the molding cycle is stopped for a short time. Standby remains active until the run button is pressed.</p>
	<p>[Boost] This mode allows you to temporarily raise the temperatures of selected zones for a set period. Boost values are entered on the Setup screen on a zone by zone basis. Any zones that are left at zero will not respond to a Boost request but stay at their normal operating temperature. During a Boost command, the Boost time set in the global configuration is the main determining factor. If, on a slow responding manifold, you set a high Boost temperature while the Boost time is set short, then the zone is unlikely to reach your set Boost temperature before the Boost time limit expires.</p>

Heat Zone Display

Each heat zone is displayed as a control panel that carries five pieces of information. The window changes color to show normal and alarm states.

Table 7-20 Heat Zone Display		
	<p>← Zone Identifier or Alias</p> <p>← Actual Zone Temperature</p> <p>← Temperature Set Point</p> <p>← Power Level / Current</p>	
	<p>Green lettering on a black background: Temperature within range.</p>	
	<p>White lettering on a red background: Fatal error or temperature exceeds alarm limits.</p>	

Adjust Heat Zone Set Points

Select the desired zone(s):

- a) To select a single zone tap the desired heat zone panel.



- b) To select a group of zones:
 Tap the first zone panel.
 Tap the last zone panel.



Tap the **[Group]** button:



1. Tap the **[Set]** button to display the keypad:



2. Choose the set-point mode. The options are **[Auto]**, **[Man]** and **[Slave]**, as described below.

Auto - Tap **[Auto]** and enter the required zone temperature. This is the default mode for the controller [i.e. closed loop] where the controller output is determined as a set temperature and which relies on feedback from the thermal sensor.

Manual - Tap **[Man]** and enter the percentage power. This is an optional mode [i.e. open loop] where the controller output is fixed at a set power level, which is determined by the operator.

Slave a Zone - Tap **[Slave]** and select a similar **Master zone** from the zone list. For more information see “Slaving Zones” on page 7-30.

3. Use the number keys to enter the set point value.
 4. Tap **[Enter]** to save the set point value in the controller.

Other Keypad Buttons

[Del] - Delete: removes the last number typed in.

[Esc] - Closes the keypad and does not enter the value into the controller.

[Off] - Turns the selected zone off.

Slaving Zones

This mode can be used if a thermal sensor has failed. Rather than switching to manual, this option allows a faulty zone to be slaved to a working one. The temperature on the faulty zone then mimics the good zone that is working in auto (or closed loop).

There are several points to remember when slaving zones.

1. Zones can only be slaved to zones of the same type; i.e. manifold to manifold or probe to probe.
2. Zones that are already slaved to a master cannot be used as masters for another slave.
3. Zones cannot be slaved in loops. If zone 2 is slaved to zone 1, zone 1 cannot be slaved to zone 2.
4. Zones should only be slaved to masters of a similar power rating. Slaving a zone to master of a significantly different power rating may result in incorrect temperature regulation.
5. When a zone is slaved its temperature readout will be replaced with SLAVE.

A slave zone will be identified along with the zone it is slaved to (see below).

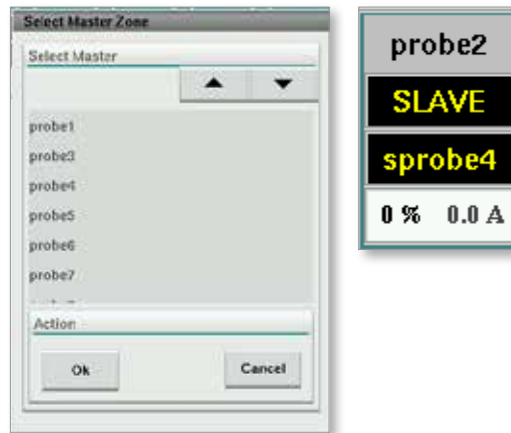

7.11.2 Setup Screen (Supervisor Level)

The Setup screen is used to set heat zone parameters and configure some global parameters.



NOTE

The Setup screen can only be accessed with supervisor or higher credentials.

Use the scroll bars to see information for all the cards within the controller. The same grid that displays this information is also used to set up the heat zone parameters. Heat zone set points such as Set Temperature and Actual Temperature are displayed here but cannot be changed from this screen. They are changed from the Monitor Screen. See “Table 7-19 Monitor Screen Control Buttons” on page 7-28 for the description of elements.

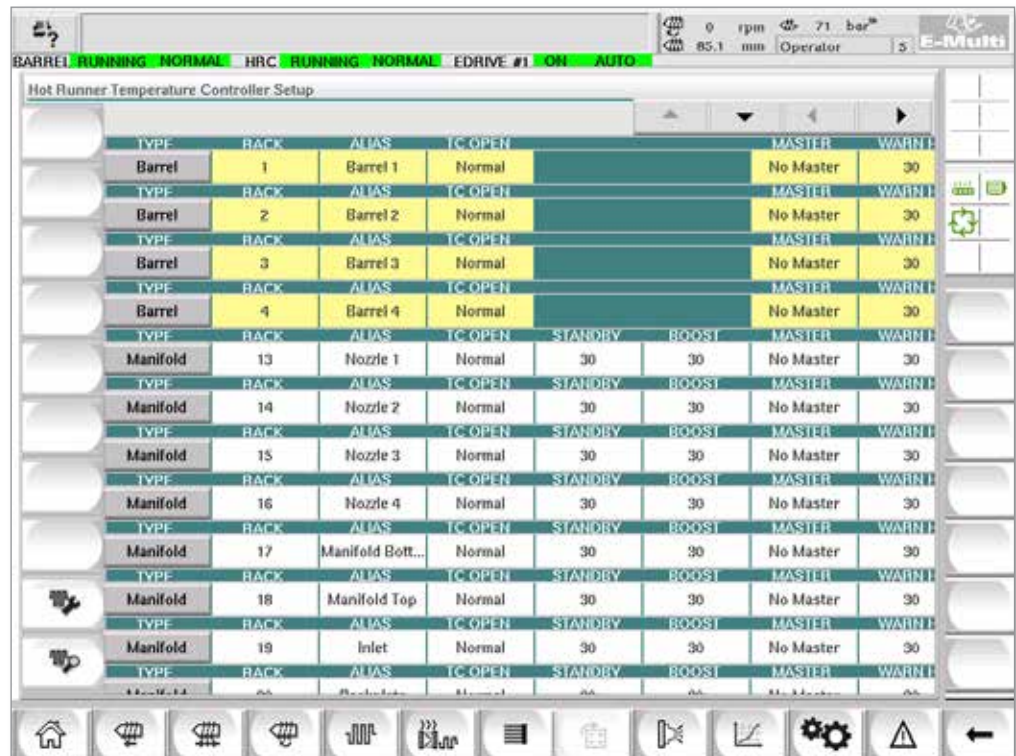

Figure 7-12 Setup screen (supervisor level)

Heat Zone Display

The first column displays all the heat zones detected on the controller. This column is used to select heat zones in order to change their parameters.

Zone parameters are identified by colored column headings.

Probe2	2	probe2	Normal	30	30	No Master	30
TYPE	RACK	ALIAS	TC OPEN	STANDBY	BOOST	MASTER	WARN HI
Probe3	3	probe3	Normal	30	30	No Master	30
TYPE	RACK	ALIAS	TC OPEN	STANDBY	BOOST	MASTER	WARN HI
Probe4	4	probe4	Normal	30	30	No Master	30
TYPE	RACK	ALIAS	TC OPEN	STANDBY	BOOST	MASTER	WARN HI
Probe5	5	probe5	Normal	30	30	No Master	30
TYPE	RACK	ALIAS	TC OPEN	STANDBY	BOOST	MASTER	WARN HI
Probe1	1	probe1	Normal	30	30	No Master	30

Adjust Heat Zone Set Points

Heat Zone parameters are accessed within the Setup screen grid.

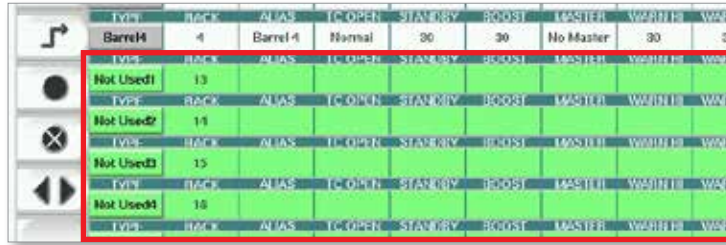

1. Select the desired zone row(s):
 - a) To select a single zone row tap the desired heat zone row.
 - b) To select a group of zones:
 - Tap the first zone row.
 - Tap the last zone row.
 - Tap the **[Group]** button.



2. Tap the parameter column.

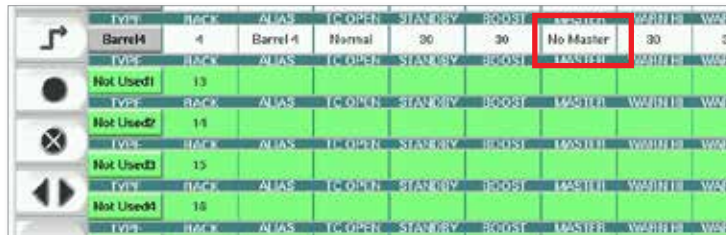

3. Tap the **[Set]** button to display the keypad.



4. Set the value. Tap **[Enter]** to save the new parameter setting in the controller.



Detect Heat Zones and Configure Zone Types

The console can run an automatic zone detection routine to detect the zones available on the controller cards. This needs to be done during initial setup of the controller or if a card change takes place.

1. Tap **[Auto Detect]** to open the Auto Detect confirmation dialog.



2. Tap **[OK]** to run the zone detection routine. Wait for Auto Detect to finish. Auto detecting zones may take up to 5 minutes.



NOTE

Auto detect will reset all barrel and hot runner controller temperature setpoints.

All available zones will be displayed on the Setup screen. They will be auto-numbered and display as Not Used without parameter settings.

TYPE	BACK	ALMS	TC OPEN	STANDBY	BOOST	MAS
Not Used1						
Not Used2						
Not Used3						
Not Used4						
Not Used5						
Not Used6						

Once auto detection completes, the setup area will be populated with heater zones. The number of zones detected should always be an even number.

Barrel	1	Barrel 2	Thermal	30	30	No Heater	30	30
Barrel 1								
Barrel 2								
Barrel 3								
Barrel 4								
Not Used1								
Not Used2								
Not Used3								
Not Used4								
Not Used5								
Not Used6								

3. To setup zone types:
 - a) Tap the first zone of the same type.

Detect Heat Zones and Configure Zone Types - continued

- b) Tap the last zone of the same type.
- c) Tap group.



- d) Tap set.



The configure heat zone window will open:



4. Select the zone type:
 - **[Not Used]** - to switch off unwanted zones.
 - **[Probe]** - Nozzle heat control required.
 - **[Manifold]** - Manifold heat control required.
5. Tap the type to place a checkmark in the desired box.
6. Tap **[OK]**.
7. Refer to the hot runner wiring diagram for a table showing heater type and position of each zone. A sample table is shown for reference:

ZONE DESCRIPTION	ZONE #	POWER PLUG I		T/C PLUG I	
		PIN	PIN	PIN +	PIN -
NOZZLE #1	1	A1	A2	1	13
NOZZLE #2	2	A3	A4	2	14
NOZZLE #3	3	A5	A6	3	15
NOZZLE #4	4	A7	A8	4	16
NOZZLE #5	5	B2	B3	5	17
NOZZLE #6	6	B4	B5	6	18

7.11.3 Utilities Screen (Supervisor Level)

The Integrated Hot Runner Controller Utilities screen is used to change the settings of the interlocks with the molding machine. These interlock signals are not necessary for operation but are supplied for customer use if needed.



NOTE

The Utilities screen can only be accessed by supervisor credentials or above level authorized personnel. See the electrical schematic for further information.

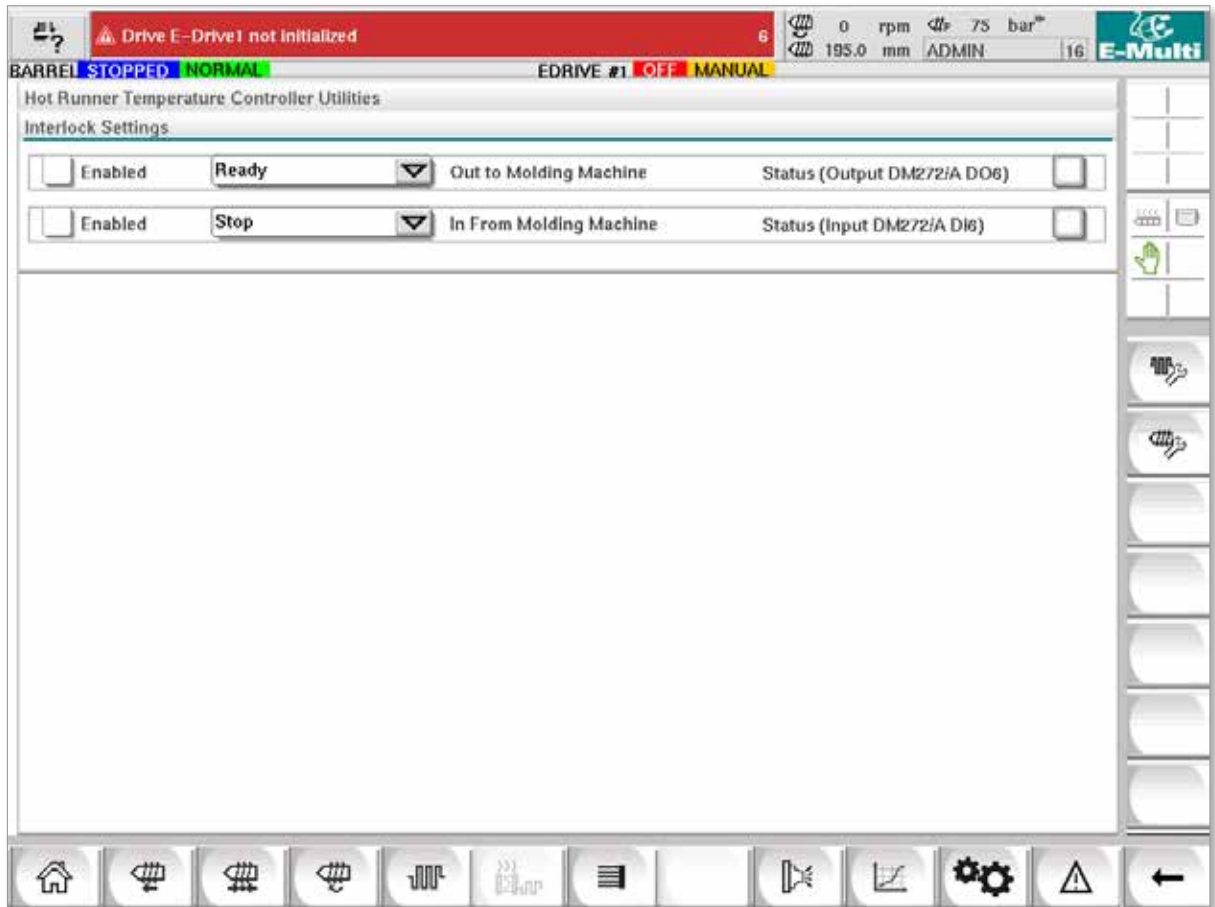
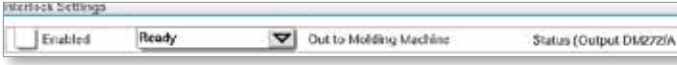



Figure 7-13 Utilities screen (supervisor level)

Utilities Screen (Supervisor Level) - continued

Table 7-21 Utility Screen Elements	
Screen Components	Description
	<p>Interlock Settings - Out to Molding Machine</p> <p>Enabling this interlock sends a signal to the molding machine when the controller is ready (i.e. heat zones are at temperature, there are no alarms and controller is in RUN mode).</p> <p>Tap the drop down box and select [Ready].</p> <p>Tap the [Enabled] box and an interlock window will open.</p> <p>Tap the checkmark to enable the interlock.</p> <p>The status (On = green) / (Off = white) and PLC address are displayed on the right.</p>
	<p>Interlock Settings - In from Molding Machine</p> <p>Enabling this interlock accepts a signal from the molding machine that forces the E-Multi temperature controller into the selected mode of operation.</p> <p>Tap the drop down box and select from the following Modes: Stop Run Standby Boost</p> <p>Tap the [Enabled] box and an interlock window will open.</p> <p>Tap the checkmark to enable the interlock.</p> <p>The status (On = green) / (Off = white) and PLC address is displayed on the right.</p>

7.12 Integrated E-Drive Control (Option)

Left Bar - E-Drive Control Buttons

E-Drive Context Buttons
Includes access to overview and setup screens for each E-Drive Plate.

The screenshot displays the E-Drive control interface for 'E-Drive Plate #1'. At the top, a red status bar indicates 'Drive E-Drive1 not initialized'. Below this, a control bar shows 'STOPPED' and 'NORMAL' modes, and 'EDRIVE #1 OFF MANUAL'. The main area features a central diagram of a 'Typical Pin' with a red line indicating its position. To the left of the diagram, 'Actual Position' is shown as 'Plate #1 Pos' at '0.00 mm', and 'Open Position' is set to '8.00 mm'. To the right, 'Actual Torque' is 'Plate #1 Torq' at '0 %'. Below the diagram, 'Start Closing Trigger' is set to 'Time Only' with a 'Delay' of '0.0' to '2.0 s' and a 'Velocity' of '10 mm/s'. 'Start Opening Trigger' is set to 'Mold Closed: ZA6' with a 'Delay' of '0.0' to '0.0 s' and a 'Velocity' of '10 mm/s'. The 'Close Position' is highlighted in green and set to '0.00 mm'. The interface includes a left bar with control icons, a right bar with context buttons, and a bottom bar with navigation and system icons.









Lower Bar - E-Multi Screen Navigation and System Buttons
See "Bottom Bar - Screen Navigation Buttons" on page 7-6 .

Figure 7-14 E-Drive control screen components

7.12.1 E-Drive Control Buttons

On the left hand edge of each screen is the E-Drive button bar.

To operate functions simply tap the button using either your fingers or a blunt pointer.

Table 7-22 E-Drive Control Buttons	
Button	Description
	Auto – Required to automatically sequence the E-Drive controller based on external triggers.
	Manual – Used for Home and jog mode.
	Home – Used to reference the E-Drive controller (set the forward – 0.00) position.
	Step ON – Each press of the step button will step the E-Drive controller through one step of the automatic sequence.
	Jog Forward- used to manually move the plates forward. Position is ignored. Only available in setup mode.
	Jog Backward – used to manually move the plates back. Position is ignored. Only available in setup mode.
	Servo Drive Management functions.
	Servo State - used to turn the E-Drive servo drive on and off. Button will be green when servos are enabled.

7.13 Overview Screen

This screen gives an overview of the Integrated E-Drive operation. If more than one E-Drive plate is in use, additional context menu buttons will be accessible on the right. However, if Master mode is used, any slaved plates will not be accessible on the right, only master plates.

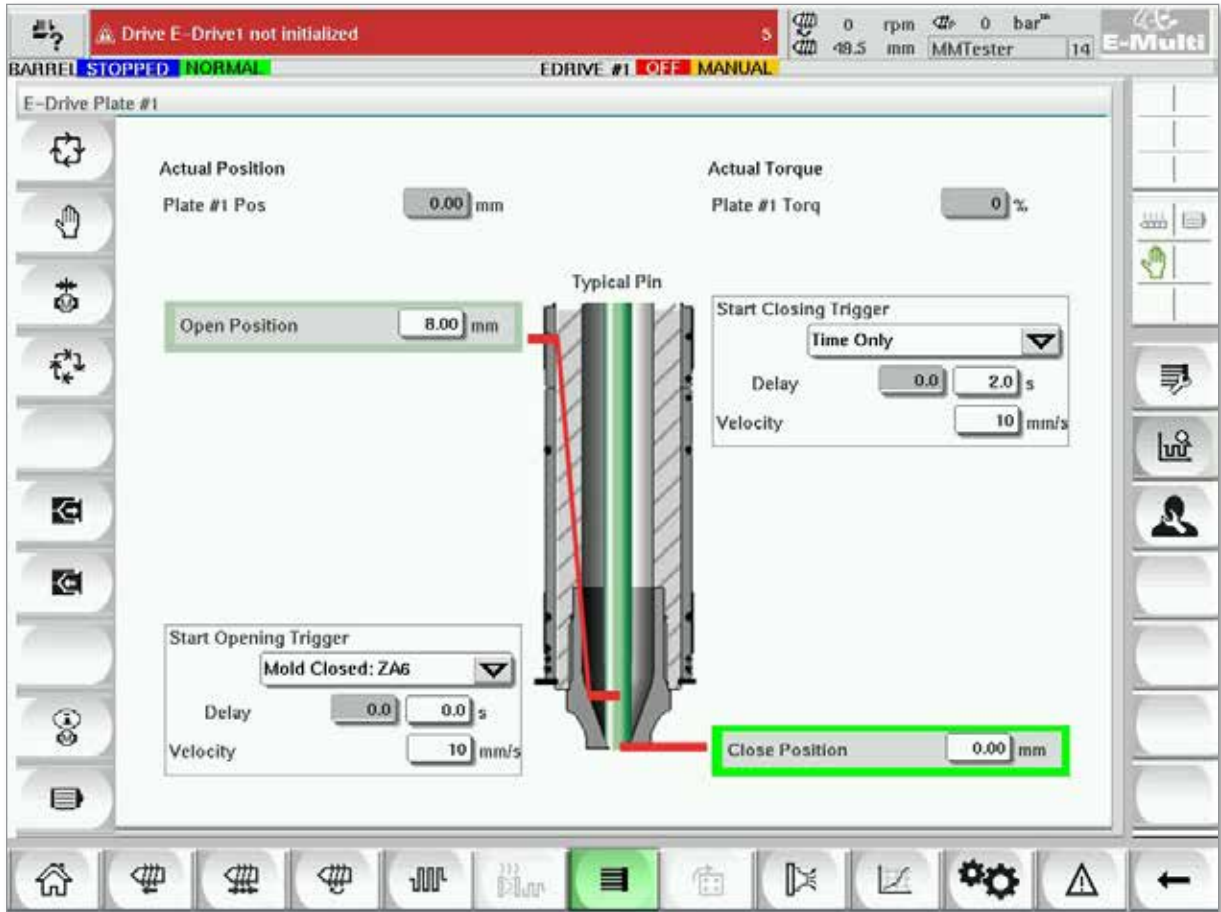

Figure 7-15 E-Drive controller overview screen

Table 7-23 E-Drive Overview Screen Elements	
Screen Elements	Description
	This field shows the actual plate position relative to the forward hardstop position when the plate was last referenced (See Homing on next page).
	This field shows the real-time motor torque for the plate 1 motor.
	<p>The [Start Opening Trigger] is selected from the drop down list. See Trigger Configuration.</p> <p>A time delay may also be added.</p> <p>The [Set Velocity] button opens a dialog where users may further adjust settings.</p>

Overview Screen - continued

Table 7-23 E-Drive Overview Screen Elements	
Screen Elements	Description
	When the trigger conditions in the first step are met, the E-Drive controller will move the plate to the [Opened position]. The actual open position is displayed here.
	The [Start Closing Trigger] initiates the E-Drive closing sequence. The trigger is selected from the drop down list. A time delay can also be added. The [Set Velocity] button opens a dialog where users can further adjust settings.
	When the trigger conditions in the step above are met, the E-Drive controller will move the plate to the [Closed Position]. This also represents the starting position for the next cycle.

7.13.1 Homing

Prior to running the E-Drive, the pin position must first be referenced.

1. The E-Multi must be in setup mode and the E-Drive Servo must be turned ON.
2. Press the [**Home**] button to initiate the automatic reference cycle, which is described below.
 - STEP 1 – Move pins all the way back (IN) to the hardstop.
 - STEP 2 – Move pins all the way forward (OUT) to the hardstop.
 - STEP 3 – Calibrate this position as 0.00.
 - STEP 4 – Move the pins to the Closed Position.
3. The E-Drive can now be run in step mode or switched to Auto mode.

Table 7-24 E-Drive Screen Context Menu Buttons	
	<p>E-Drive Overview Screen Goes to the Integrated Hot Runner Control Setup screen where Integrated Hot Runner Control settings can be adjusted.</p>
	<p>E-Drive Settings Screen Goes to the E-Drive Settings screen where settings can be adjusted.</p>
	<p>Production Graph - Customizable view.</p>

7.14 Settings Screen (Supervisor Level)

This screen gives an overview of the Integrated E-Drive operation. If more than one E-Drive plate is in use, additional context menu buttons will be accessible on the right. However, if Master mode is used, any slaved plates will not be accessible on the right, only master plates.

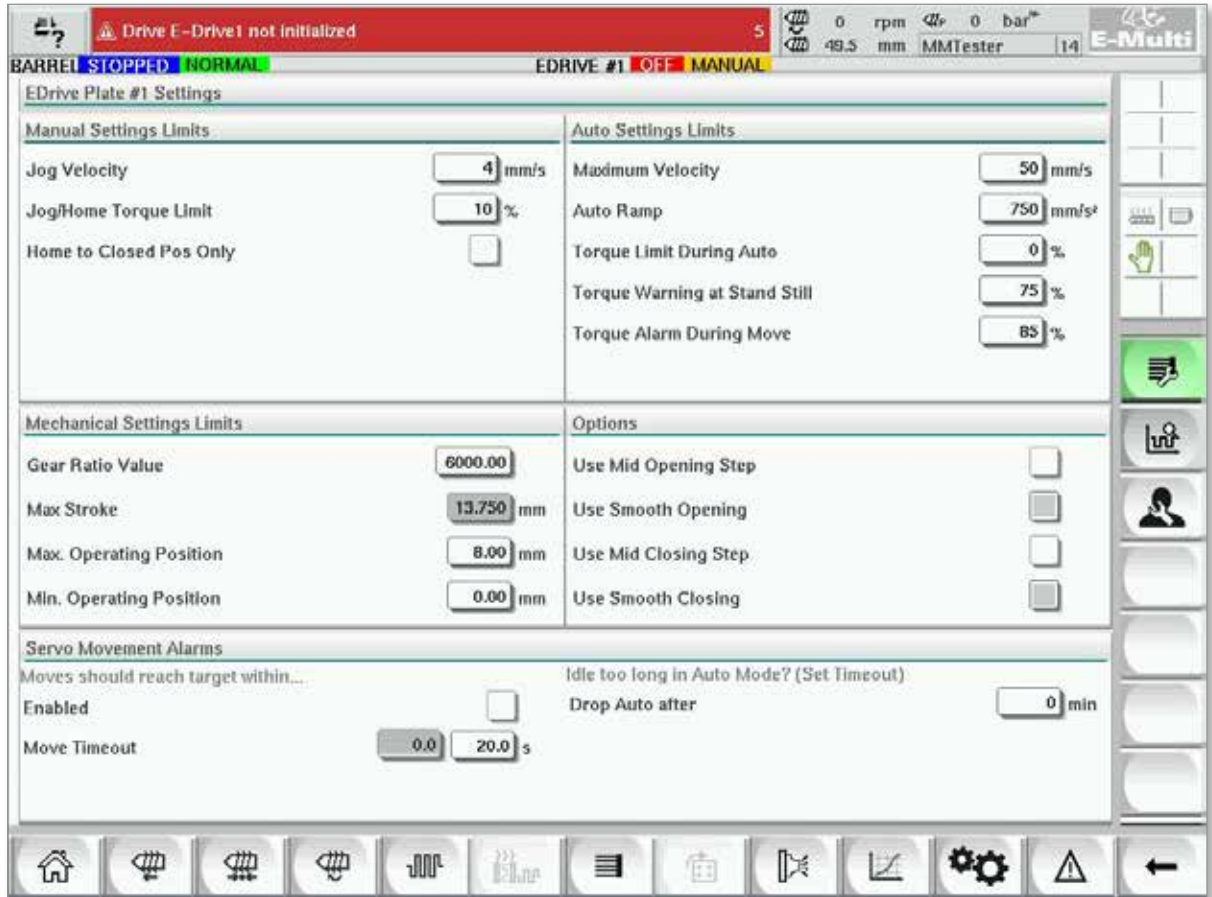

Figure 7-16 E-Drive setting screen

Settings Screen (Supervisor Level) - continued

Table 7-25 E-Drive Settings Screen Elements	
Screen Elements	Description
	<p>Manual Settings Limits Sets the maximum limits available for adjustment when in manual mode.</p> <p>Home to Closed Position Only The plate moves to home position, finds the hard stop and does not check the stroke by going to the other hard stop.</p>
	<p>Auto Settings Limits Sets the maximum limits available for adjustment by the operator on the overview screen.</p> <p>Torque Warning and Alarm Thresholds Sets the threshold (%) at which warnings and alarms would be generated.</p>
	<p>Mechanical Settings Limits</p> <p>Gear Ratio Value: This is the overall rotational motor degrees per each linear mm of stroke.</p> <p>Maximum Stroke: This the maximum stroke set for the E-Drive plate. This is set at the factory.</p>
	<p>Options A mid opening or closing step may be activated here.</p> <p>If activated, fields for setting position and delay will be available on the Overview screen.</p> <p>Smooth opening/closing E-Drive plate transitions from one step to another step without stopping.</p>
	<p>Servo Movement Alarms Moves should reach target within the specified time. If the position is not reached, the system will fault.</p> <p>Enabled - check to enable Time setting after which it times out.</p>
	<p>Idle too long in Auto Mode? (set timeout) Exit from Auto mode after the specified period of inactivity.</p>

7.15 Valve Gate Settings Screen

This screen is used to control individual valve gates, typically for single acting solenoids in pneumatic or hydraulic systems.

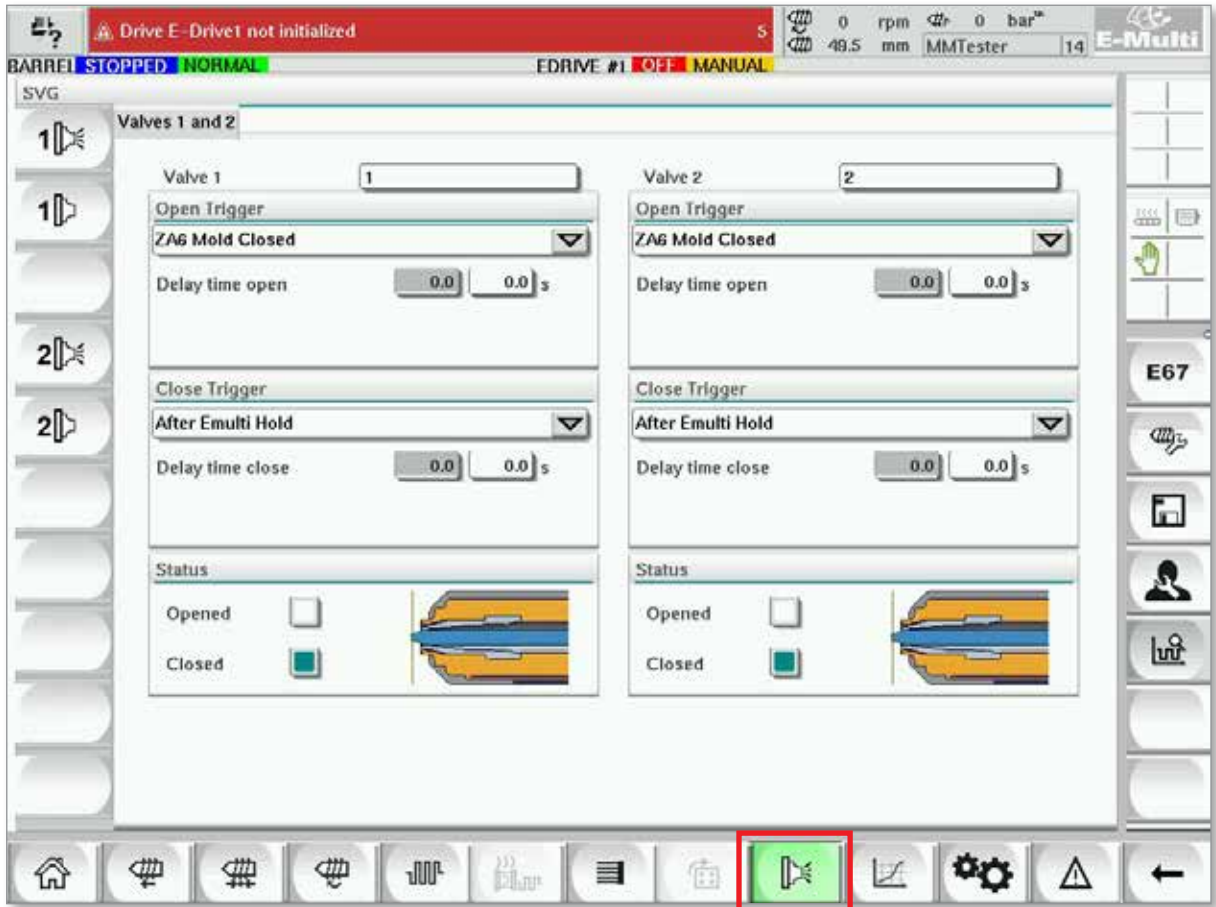
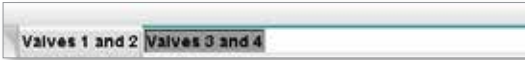
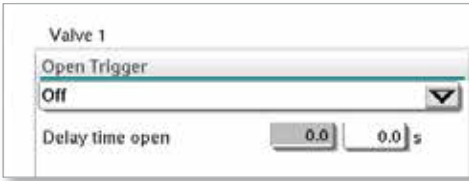
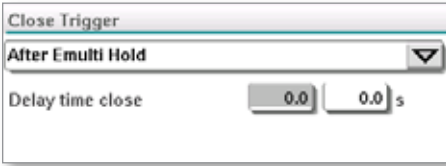



Figure 7-17 Valve gate settings screen

Valve Gate Settings Screen - continued

Table 7-26 Valve Gate Settings Screen Elements	
Screen Components	Description
	<p>Top Tabs The tabs at the top of the screen take the user to the settings for two valve gates at a time (e.g. Valves 1 and 2; Valves 3 and 4). For each valve gate the user can set the <i>Open</i> and <i>Close</i> triggers and timing.</p>
	<p>Open Trigger Drop down options: Off MoldClosing ZA6 Mold Closed - signal ZB3 Eject 1 Bwd- signal (ejection) ZB4 Eject 1 Fwd- signal (ejection) ZB5 Core 1 Pos 1- signal (robot) ZB5 Core 1 Pos 2- signal (robot) ZB5 Core 2 Pos 1- signal (robot) ZB5 Core 2 Pos 2- signal (robot)</p> <p>Delay time open In addition to the open trigger, a delay time in seconds may be added to fine tune the valve movement relative to the trigger signal.</p>
	<p>Close Trigger Drop down options: After E-Multi Hold After E-Multi Decompression After E-Multi Plasticize</p> <p>Delay time close In addition to the close trigger, a delay time in seconds may be added to fine tune the valve movement relative to the trigger signal.</p>
	<p>Current Status A green indicator box shows whether the valve gate is currently open or closed.</p>

7.16 Shutoff-Nozzle Settings Screen

The shutoff-nozzle settings screen is used to configure an optional shutoff nozzle:

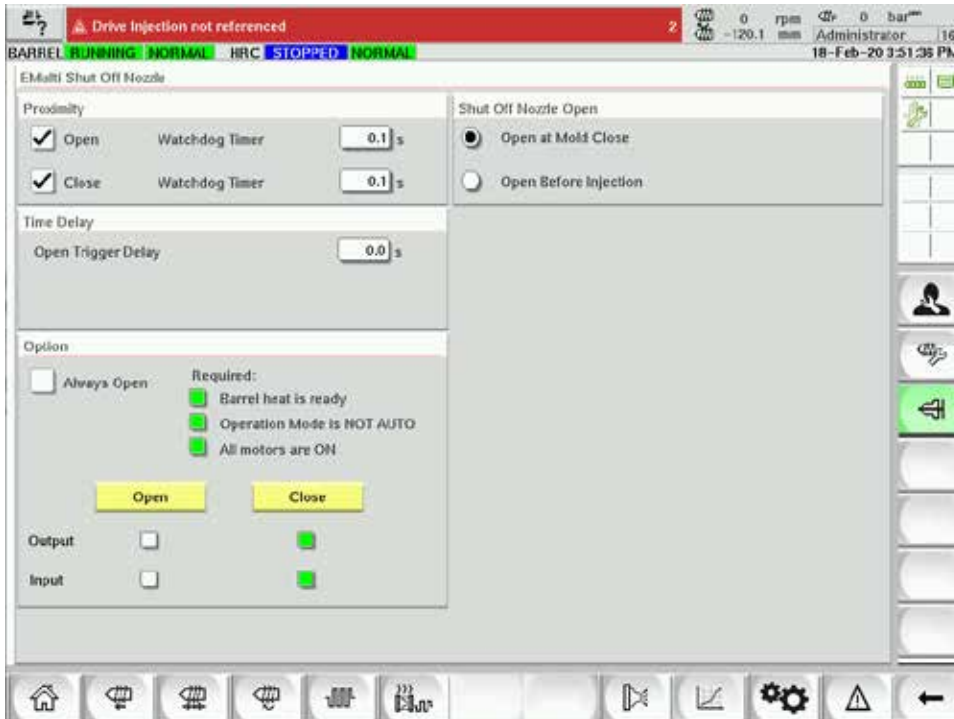



Table 7-27 Screen Elements of Shutoff-Nozzle Settings

Screen Element	Description
	<p>Proximity When the open or close boxes are checked, the shutoff nozzle has sensors to indicate that the nozzle is in the open or closed position.</p> <p>Watchdog Timer When sensors are present, the watchdog timers set the maximum time for the shutoff to change state after the trigger is received.</p>
	<p>Move Time When sensors are not present, the watchdog timers change to move timers. These timers add a delay to the process to allow the shutoff nozzle to open or close before the process continues.</p>

Table 7-27 Screen Elements of Shutoff-Nozzle Settings	
Screen Element	Description
	<p>Shut Off Nozzle Open Selects the open trigger for the shutoff nozzle.</p> <p>Mold Close—The shutoff nozzle opens when the Mold Close (A6) signal from the IMM turns on.</p> <p>Before Injection—The shutoff opens when the injection trigger specified on the E67 settings page turns on.</p>
	<p>Time Delay Adds a delay of the specified time after the open trigger turns on.</p> <p>The delay is only active if the open trigger is Mold Closed and the injection trigger is not Mold Closed.</p> <p>Delay time is ignored if the shutoff nozzle is set to Always Open.</p>
	<p>Close Trigger The shutoff nozzle closes automatically after pre-decompression (also known as decompression before plasticize) completes.</p> <p>If a recovery delay is set on the recovery settings page, the shutoff nozzle will close after the recovery delay has elapsed.</p> <p>Option—Always Open The shutoff nozzle may be set to always be open for testing or in case where the process does not require the shutoff nozzle to be closed.</p> <p>The nozzle will stay open except when the safety gate is opened, an emergency stop condition is present, or the system is turned off.</p>
	<p>Manual Operation Tapping the Open or Close buttons will open or close the shutoff nozzle if the movement conditions are met.</p> <p>With Sensors The Output indicators show the status of the PLC outputs to the hydraulic or pneumatic valve.</p> <p>The Input indicators show the status of the sensors.</p>

Table 7-27 Screen Elements of Shutoff-Nozzle Settings	
Screen Element	Description
	<p>Without Sensors Only the Output indicators are shown.</p>
<p>Required:</p> <ul style="list-style-type: none"> <input checked="" type="checkbox"/> Barrel heat is ready <input checked="" type="checkbox"/> Operation Mode is NOT AUTO <input checked="" type="checkbox"/> All motors are ON 	<p>Movement Conditions The shutoff nozzle will only operate if certain conditions are met.</p> <p>The barrel heats must be up to temperature and auto-soak completed successfully or the soak timer must be finished.</p> <p>The shutoff nozzle cannot be operated manually when the system is in automatic mode.</p> <p>The servo motors must be on (F10 LED on).</p>

7.17 Shutoff-Nozzle Settings Screen—Kortec

The following screens are used to configure the shutoff nozzle on Kortec co-injection systems.

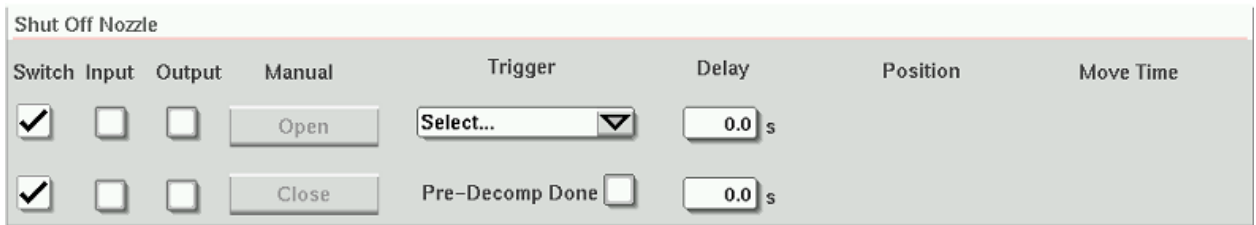

Figure 7-18 Kortec shutoff-nozzle configuration with sensors

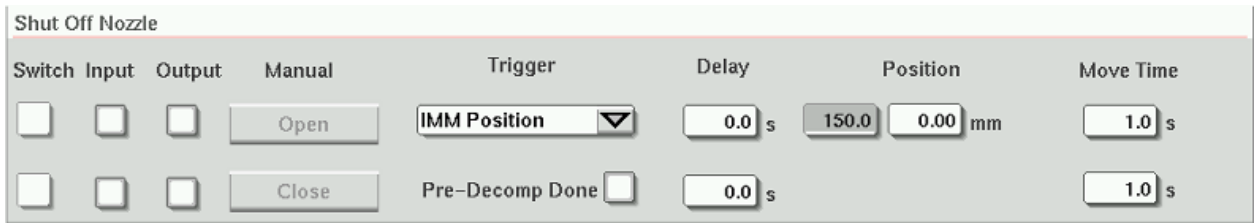

Figure 7-19 Kortec shutoff-nozzle configuration without sensors

Table 7-28 Screen Elements of Shutoff Nozzle Settings		
Screen Element		Description
		<p>Switch When the open or close boxes are checked, the shutoff nozzle has sensors to indicate that the nozzle is in the open or close position.</p> <p>Move Time When sensors are not present, the move timer fields appear and these timers add a delay to the process to allow the shutoff nozzle to open or close before the process continues.</p>
		<p>Manual Operation Tapping the Open or Close buttons in will open or close the shutoff nozzle if the movement conditions are met.</p> <p>With Sensors The Output indicators show the status of the PLC outputs to the hydraulic or pneumatic valve.</p> <p>The Input indicators show the status of the sensors.</p> <p>Without Sensors Only the Output indicators are shown.</p>

Table 7-28 Screen Elements of Shutoff Nozzle Settings	
Screen Element	Description
	<p>Open Trigger Selects the open trigger for the shutoff nozzle.</p> <p>Mold Close—The shutoff nozzle opens when the Mold Close (A6) signal from the IMM turns on.</p> <p>Remote Trigger—The shutoff opens when the Remote Trigger signal from the IMM turns on.</p> <p>Before Injection—The shutoff opens when the injection trigger specified on the E67 settings page turns on.</p> <p>Always Open—The shutoff nozzle stays open except when the safety gate is opened, an emergency stop condition is present, or the system is turned off.</p>
	<p>Open Trigger—IMM Position The shutoff nozzle opens when the IMM screw position falls below the Position setpoint.</p> <p>The field with the gray background displays the IMM position in real time.</p> <p>Delay—Open Adds a delay of the specified time after the open trigger turns on.</p> <p>Delay time is ignored if the shutoff nozzle is set to Always Open.</p>

Table 7-28 Screen Elements of Shutoff Nozzle Settings							
Screen Element	Description						
<table border="1"> <thead> <tr> <th>Trigger</th> <th>Delay</th> </tr> </thead> <tbody> <tr> <td> <input type="text" value="IMM Position"/> ▼ </td> <td> <input type="text" value="0.0"/> s </td> </tr> <tr> <td> Pre-Decomp Done <input type="checkbox"/> </td> <td> <input type="text" value="0.0"/> s </td> </tr> </tbody> </table>	Trigger	Delay	<input type="text" value="IMM Position"/> ▼	<input type="text" value="0.0"/> s	Pre-Decomp Done <input type="checkbox"/>	<input type="text" value="0.0"/> s	<p>Close Trigger The shutoff nozzle closes automatically after pre-decompression (also known as decompression before plasticize) completes.</p> <p>The indicator turns on when pre-decompression completes.</p> <p>Delay—Close Adds a delay of the specified time after the pre-decompression is complete.</p> <p>If a recovery delay is used the recovery delay is added after this delay.</p> <p>Delay time is ignored if the shutoff nozzle is set to Always Open.</p>
Trigger	Delay						
<input type="text" value="IMM Position"/> ▼	<input type="text" value="0.0"/> s						
Pre-Decomp Done <input type="checkbox"/>	<input type="text" value="0.0"/> s						

7.18 Production Graph Screen

The Production Graph Screen provides real time data on the current production process. Menu buttons at the bottom of the screen provide access to other settings (Setup, Zoom, View, Tolerances, etc.).

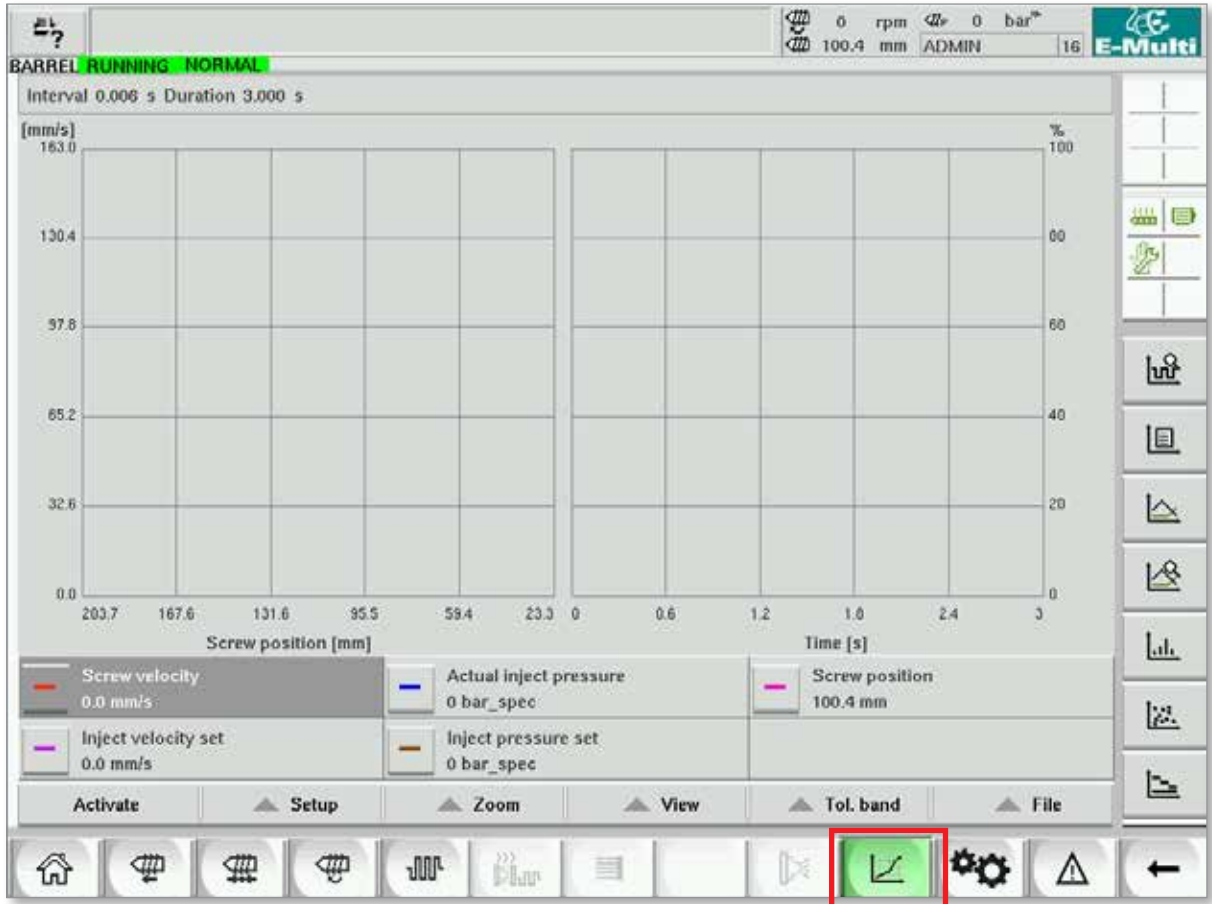

Figure 7-20 Production graph screen

↑
**Lower Button - Default
Production Graph View**

Production Graph Screen - continued

Table 7-29 Production Graph Screen Elements	
Screen Components	Description
	<p>The screen shows a graph of a selected variable. The variable name and the current values are shown below the graph. The following functions are possible:</p> <ul style="list-style-type: none"> • Definition of reference graph • Display of the last trend graph • Monitoring using a chosen tolerance band <p>The transition point, (the point at which the system changes from injection to hold pressure) is shown as a turquoise vertical line. The transition point range is shown as a white bar at the upper edge of the diagram. In a properly set up process, this bar should be very narrow. The mean value of all transition points is shown as a black line within the white bar.</p> <p>The display mode can be set as:</p> <ul style="list-style-type: none"> • Time (y/t graph) • Position (y/x graph) • Split (mixed form, both diagram types)

Table 7-30 Production Graph Screen Context Menu Buttons	
	Software Oscilloscope (SWO) Configurable view
	PD - Protocol Production data in table format
	PD - Line Graph Production data in line graph format
	PD - Supervisor Production data Supervisor settings
	PD - Histogram Production data in histogram format
	PD - Scatter Graph Production data in scatter graph format
	PD - Cycle Time Production data on cycle time

7.18.1 Lower Menu Buttons

These buttons are common to the different production graph screens. Their sub-menus and functions are described in the following table.



Figure 7-21 Production graph screen lower menu buttons

Table 7-31 Production Graph Screen Lower Menu Buttons							
Activate	Activates / deactivates the measurement. The button label toggles between activate / deactivate depending on the current status.						
Setup	<p>Configuration: Opens the general configuration dialog. See “7.18 Production Graph Screen” on page 7-52.</p> <p>Set all ref. curves: This is used to select all displayed curves as reference curves. Pressing the button again cancels the selection of reference curves.</p> <p>Export: Opens the Export Settings dialog for the export of measurements. See "Export Settings" on page 9-18 for more detail.</p> <p>Load original setup: If data from a file was loaded and displayed via the import function, this function can be returned to for the currently running measurement.</p>						
Zoom	<p>Zoom xxx%: Enlarges the displayed area by the corresponding factor.</p> <p>User defined: An arbitrary area can be selected and the display magnified here.</p> <p>Auto scale: The x/y scales are automatically adapted to the optimum scaling.</p>						
View	<p>Actual value: Shows the actual value cursor (shown by a red cross on the curve) that can be shifted using the Left and Right position buttons. The measurement values at this position are displayed in the legend.</p> <p>Pressing the Cancel button exits the dialog.</p> <p>Maximize: Enlarges or shrinks the displayed graph (display/hide legend).</p> <p>Tol.band: Activates or deactivates the display of the tolerance bands for all curves.</p> <p>Trend: Display / hide the trend display.</p> <p>The previous curves are displayed simultaneously with the current curves in a slightly lighter color than the current curve. The number of curves to be displayed can be set in the settings dialog and is limited to 10 curves.</p> <p>Reference: Activates or deactivates the display of the reference curve for all curves.</p>						
Tolerance band	<p>Transfer: Enables the transfer of curves into a monitoring range, inside which the curve is to move. A selection dialog allows the choice of whether a reference curve or trend curves are used as source for the tolerance band. If the trend curve or reference curve are not available, the corresponding selection box is deactivated. The selection box is also deactivated if no matching tolerance properties were entered.</p> <p><i>Selection Dialog</i></p> <table border="0"> <tr> <td><i>Name</i></td> <td>Display of the available curves.</td> </tr> <tr> <td><i>Ref.</i></td> <td>If this field is activated, the tolerance band for the curve is transferred from the reference curve. This field is only available if a reference curve is saved.</td> </tr> <tr> <td><i>Trend</i></td> <td>If this field is activated, the tolerance band for the curve is transferred from the trend curve. This field is only available if trend curves are available.</td> </tr> </table>	<i>Name</i>	Display of the available curves.	<i>Ref.</i>	If this field is activated, the tolerance band for the curve is transferred from the reference curve. This field is only available if a reference curve is saved.	<i>Trend</i>	If this field is activated, the tolerance band for the curve is transferred from the trend curve. This field is only available if trend curves are available.
<i>Name</i>	Display of the available curves.						
<i>Ref.</i>	If this field is activated, the tolerance band for the curve is transferred from the reference curve. This field is only available if a reference curve is saved.						
<i>Trend</i>	If this field is activated, the tolerance band for the curve is transferred from the trend curve. This field is only available if trend curves are available.						
File	<p>Start Export: Starts the export of the current curve to a file.</p> <p>Load Measurement: Opens a saved measurement and shows the variable values in the diagram.</p>						

7.19 Software Oscilloscope

This dialog is accessed by choosing the Setup, then [Configuration] button. There are four tabs: Measure parameter, Trigger, Parameter and Line color. These will be described below and other graph screen configuration is very similar.

7.19.1 Measure Parameter

Used to set the measurement recording parameters like trigger, interval and duration.

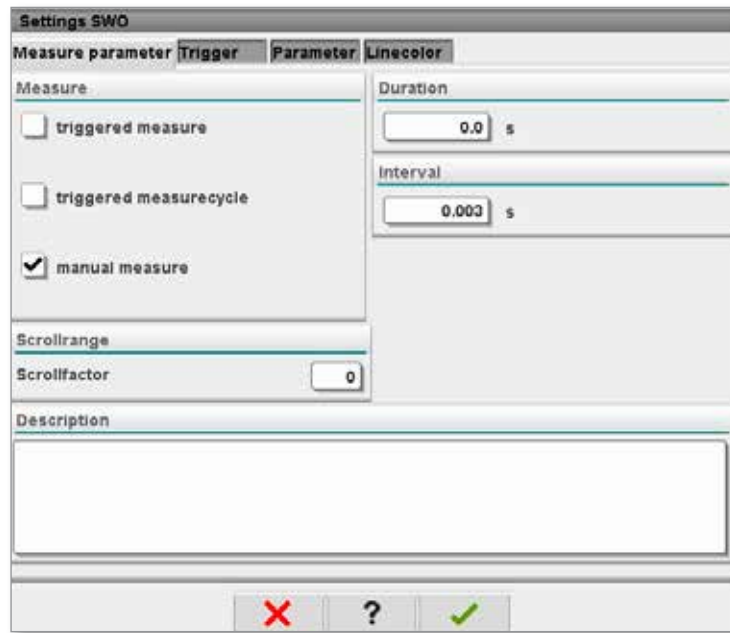

Table 7-32 Measure Parameter Tab Fields

Field	Description
Triggered Measure	Starts a single set of measurements from the trigger signal for the set duration. The display is maintained until a graph is activated again.
Triggered Measure Cycle	Starts a set of measurements from the trigger signal for the set duration. A new set of measurements is started at the first trigger after the set duration is reached.
Manual Measure	A single set of measurements is made when manually triggered by the operator.
Duration	Specifies the total measurement duration (seconds). This field can only be modified when the measurement is stopped. NOTE: This also deletes all trends, references and measurement curves.
Interval	Displays the time period between two measurements (seconds). This is automatically calculated by the system.
Scroll Range	Defines the area for scrolling around the fully drawn graphic.

Software Oscilloscope - continued

7.19.2 Trigger

Used to select the variable that will be used to trigger measurement.

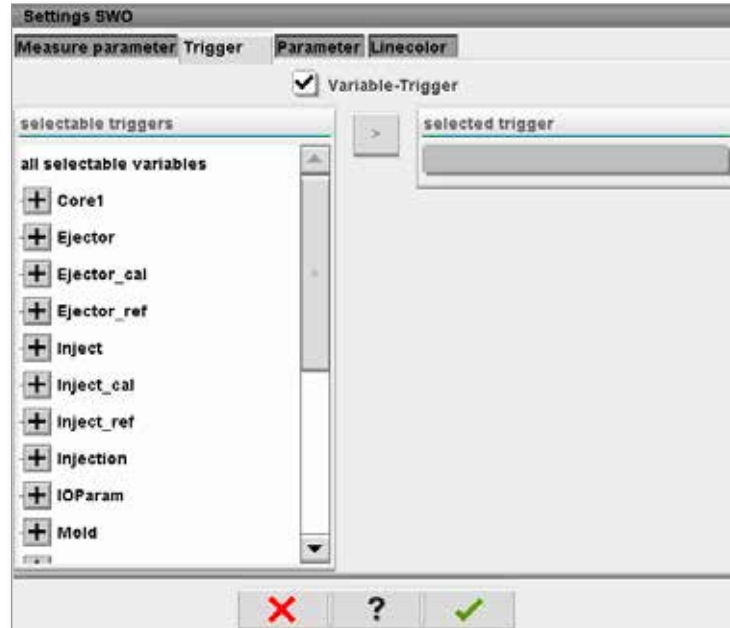

7.19.3 Parameter

Used to select the variable that will be recorded. The Process parameter column lists all available variables. The Selection column lists the variables that are selected for recording.

The selection can be made by using the arrow buttons >, < and <<.

> Adds the highlighted variable from the process parameter list to the selection list.

< Removes the highlighted element from the selection list.

<< Removes all elements from the selection list.

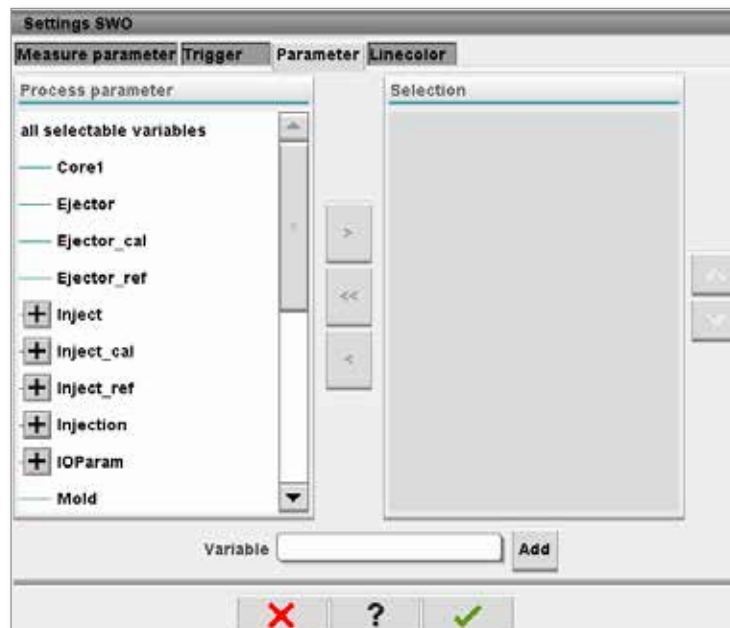

7.19.4 Line Color

Line color selection for displayed curves.

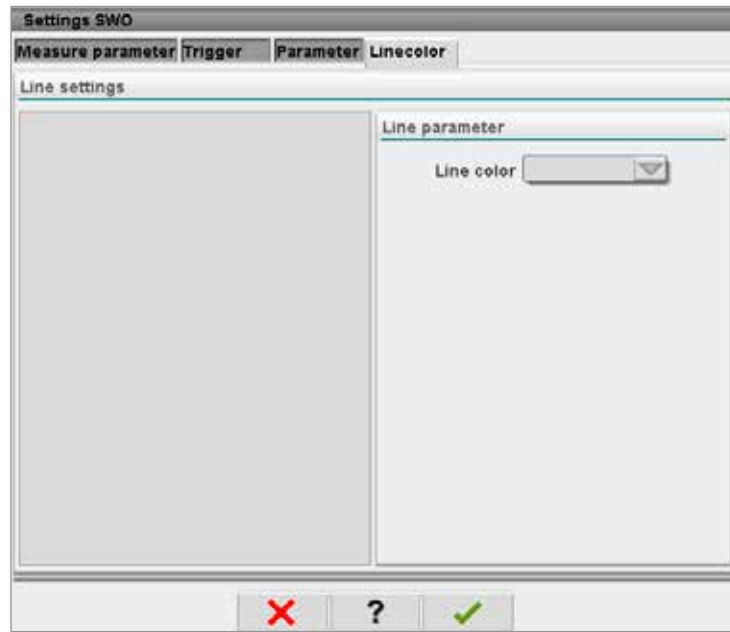

7.20 Process Data (PD) Protocol Screen

The process data protocol screen serves to show process data in tabular form. The recorded values can be printed out during measurement or saved to a file for analysis. The context menu button on the right can also be used to view the process data in other forms (histogram, scatter graph, etc.). See the controller help file for information on saving and printing recorded values.

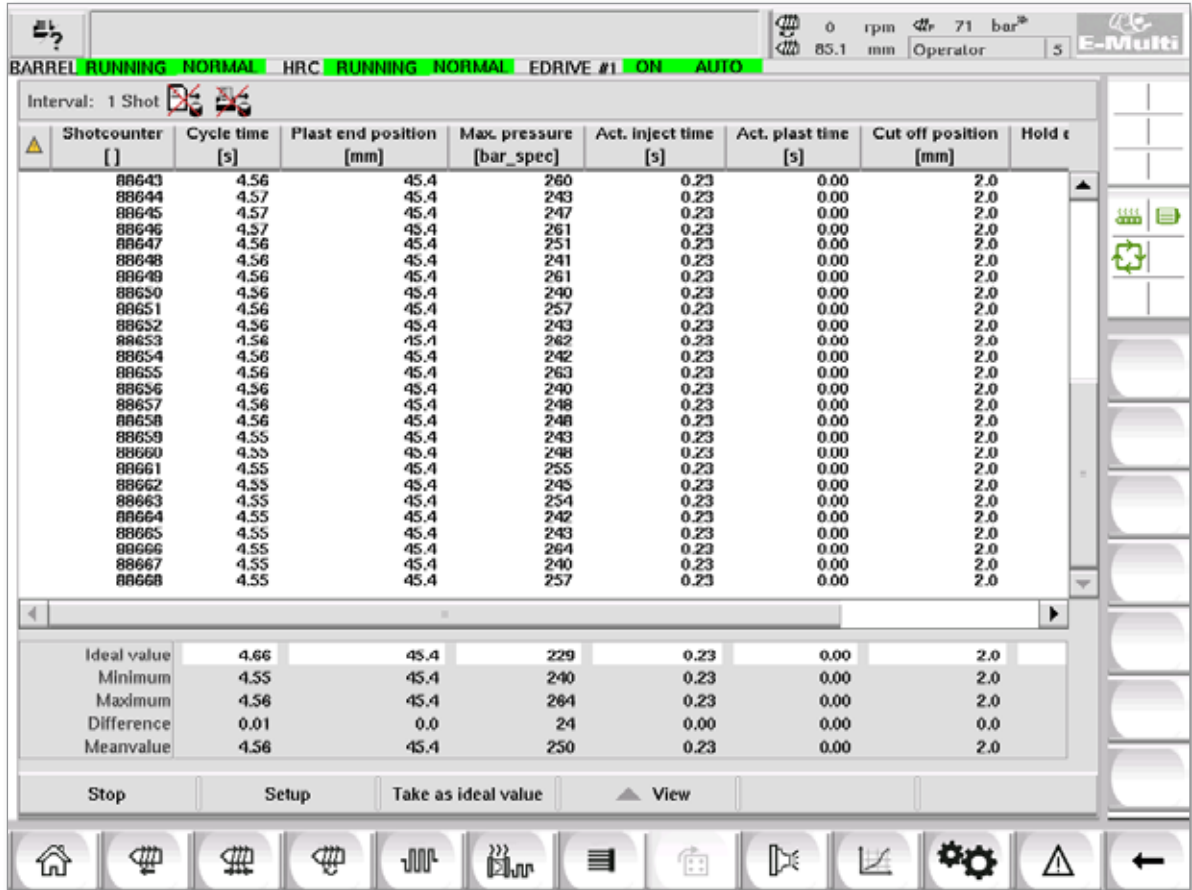

Figure 7-22 Process data protocol screen







Screen Components		Description
		<p>The recorded system variables are shown in a table. Process variables are user selectable and any number of variables may be selected. The table can be scrolled horizontally and vertically.</p> <p>The color scheme of the individual columns can be selected in PDP setup.</p> <p>The lower part of the screen shows the reference value, minimum, maximum and the difference between the two values, as well as the mean value for each process value.</p> <p>The number of cycles (injections) that are taken into account can be adjusted. The default is 20 cycles.</p>

7.20.1 Lower Menu Buttons



Figure 7-23 Process data screen lower menu buttons

Table 7-34 Process Data Screen Lower Menu Buttons	
Start / stop	Starts and stops the measurement of process data. The button is displayed alternatively depending on the current status of the measurement.
Setup	Opens the settings dialog of the PD protocol.
Take as ideal value	The values of the current measurement are set as reference values. Further measurements can be compared with these values.
View	<p>Details off: This option is used to show or hide the status line at the upper edge of the screen.</p> <p>Delete: Deletes the displayed data.</p> <p>Keep list / clear list: Stops or starts the display of new values. The protocol log continues to run in the background. A new actuation of the button continues the display on the position of the current measurement.</p>

Table 7-35 Process Data Screen Context Menu Buttons	
	Software Oscilloscope (SWO) Configurable view
	PD - Protocol Production data in table format
	PD - Line Graph Production data in line graph format
	Statistical Process Control (SPC) Setup Production data Supervisor settings
	PD - Histogram Production data in histogram format
	PD - Scatter Graph Production data in scatter graph format
	PD - Cycle Time Process cycle time shown in stacked horizontal bars

7.21 Main Settings Screen



WARNING

Values on the screens in the manual may not reflect the correct values for your machine size. Do not change settings to the loaded parameters based on the screen pictures.

This screen serves as a central access point for configuration screens as well as service and maintenance screens. The functions available are determined by the user access level.

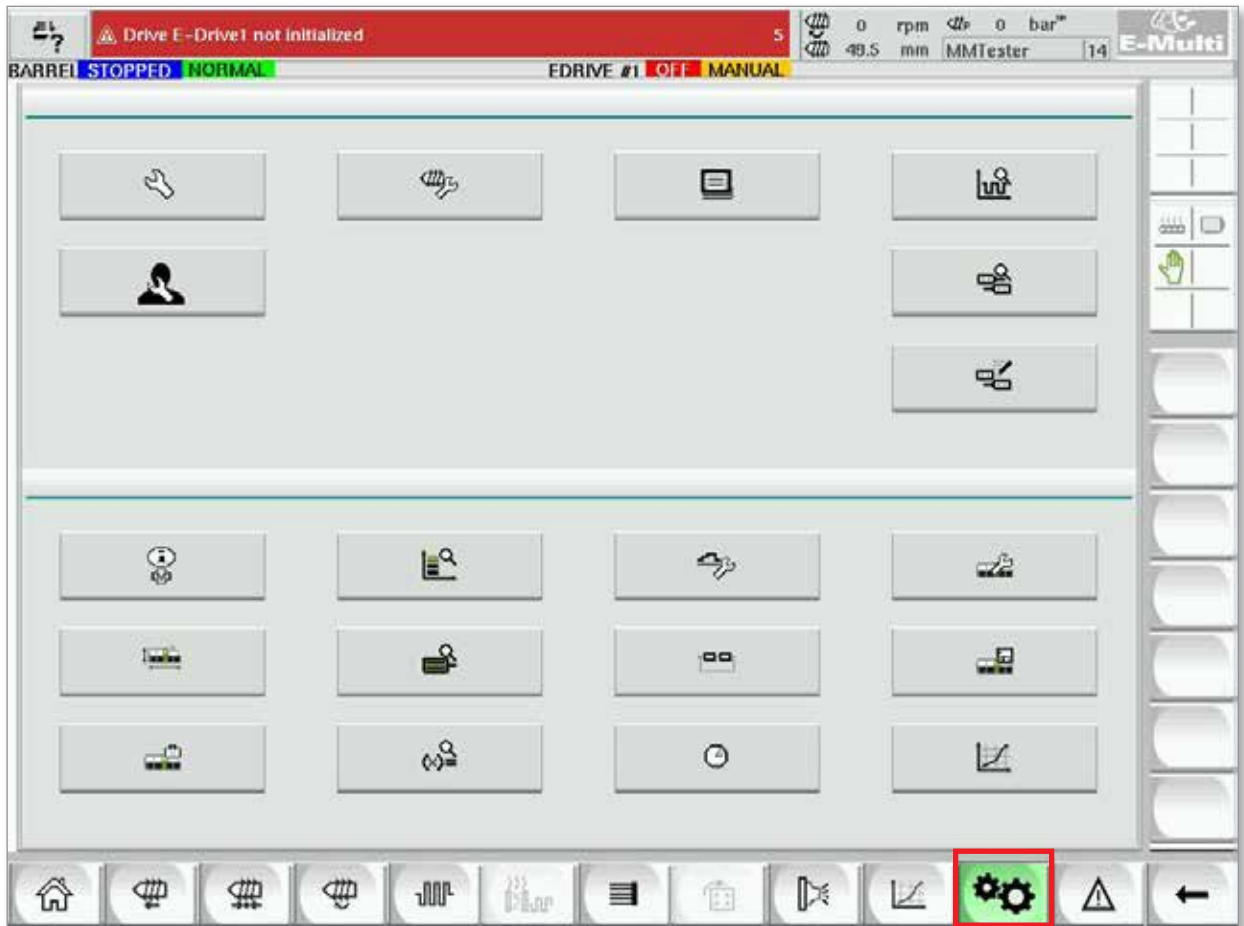

Figure 7-24 Main setting screen

Main Settings Screen - continued

The following graphic shows the names of the icons on the Machine Specification (Service Overview) screen.

Each screen will be given a high level description in the pages that follow.

If you need a more detailed description of the functionality, please contact your *Mold-Masters* representative.

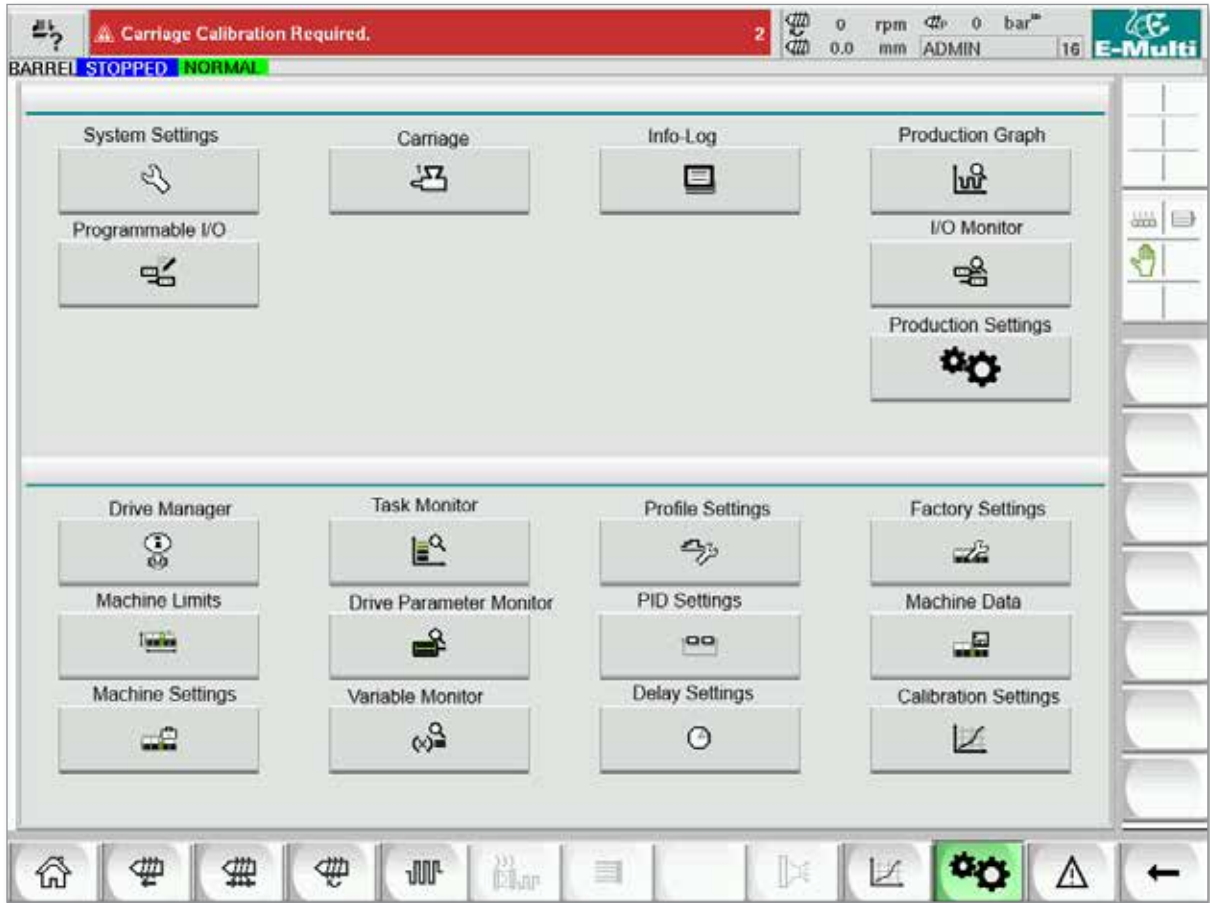

Figure 7-25 Machine specification screen icons

7.22 System Settings Screen

The System Settings screen is used to select global settings such as display language and units of measure, local date and time. Other system information is displayed, but not changed, on this screen. Additional menus can be accessed through the menu buttons at the bottom of the Setup screen, including User, Display, System, Report and Mask.

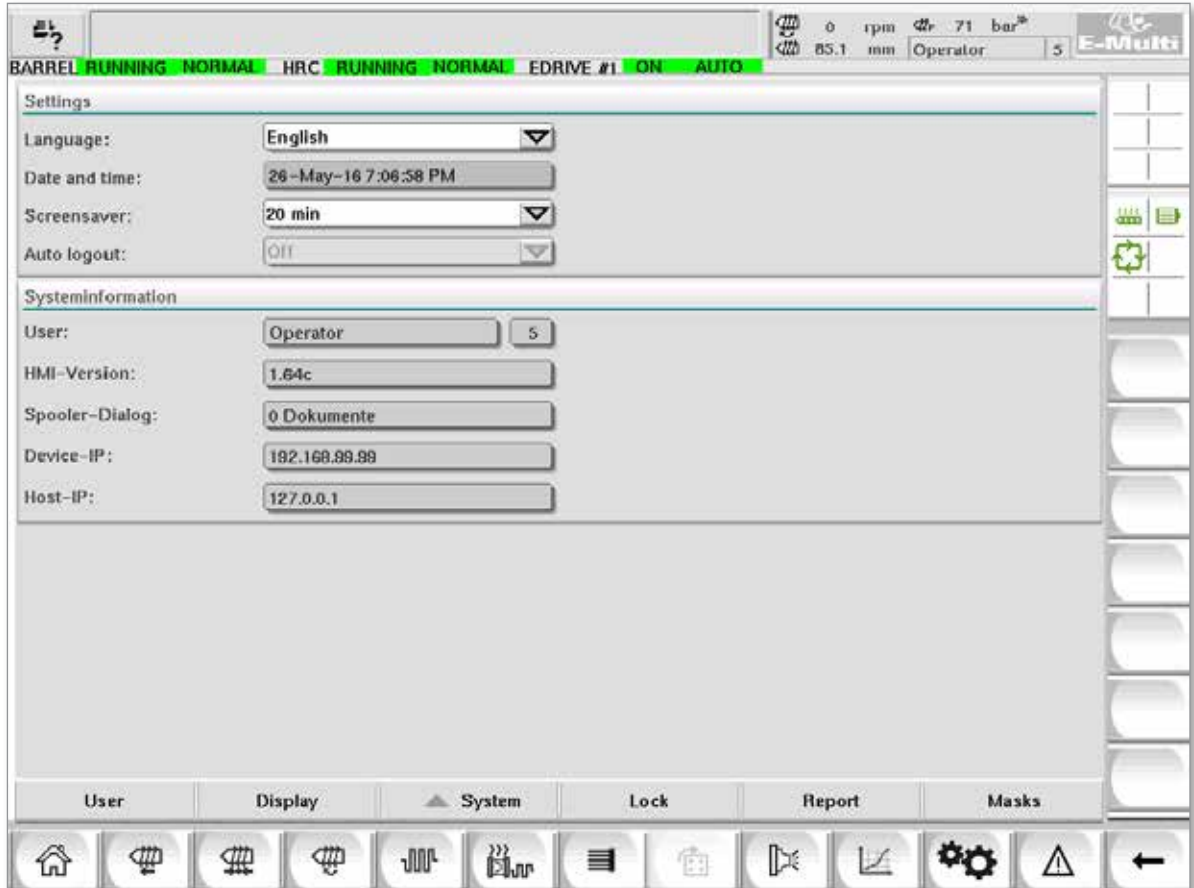



Figure 7-26 System settings screen

Table 7-36 Systems Settings Screen Components

Screen Component	Field	Description
	Language	Used to select the system language for the HMI.
	Date and time	Used to set the system date and time.
	Screen saver	Sets the time after which the HMI screen will be turned off.
	Auto Logout	Sets the time after which a logged-on user is automatically logged off.

Systems Settings Screen - continued

Table 7-36 Systems Settings Screen Components		
Screen Component	Field	Description
	User	Shows the name and access level of the current user
	HMI Version	Shows the current version of the HMI software
	Spooler Dialog	Shows the number of pending print jobs
	Device IP	Shows the IP address of the visualization system
	Host IP	Shows the IP address of the controller

7.22.1 Lower Menu Buttons



Figure 7-27 System settings screen lower menu buttons

Table 7-37 System Settings Screen Lower Menu Buttons	
Menu Buttons	
User	Opens the user login dialog. User administration may also be performed here.
Display	Adjust the brightness and contrast of the display.
System	<p>This button is used to access additional menu buttons.</p> <p>Restart HMI: Reinitializes the visualization software.</p> <p>Details: Displays a dialog box for further system information.</p> <p>System: Shows an overview of the configuration settings of the visualization and the startup times of the loaded screens.</p> <p>SysVars: Shows an overview of the system variables the system is communicating with.</p> <p>Update: Refreshes the display.</p> <p>Logfile: Saves the overview of the communicating system variables in the file hmi.log (normally in the root directory of the system drive).</p> <p>Versions: This dialog shows the system and application versions for the control and the visualization.</p> <p>Network: Opens the dialog for setting and displaying the network configuration.</p>
Lock	Locks the HMI so it can be cleaned. Screen unlocks automatically after 10 seconds.
Report	<p>Pressing this button on a local station opens a file selection dialog, in which the status report can be saved on a drive with a specified name. The drives and directories which are available can be specified in the HMI configuration.</p> <p>Pressing the [status report] button on a remote station will store the status report in the root directory of the system drive of the controller.</p> <p>The status report contains the following information:</p> <ul style="list-style-type: none"> • PMA stack (up to 4 files) • HMI event trace (key presses) • Boot log (optional) • System catalog • Info log • Current PCB configuration • Task analysis (WVR file) • Status report info file • Network status • KNet status • KNet error • Performance log <p>Note: An operator may be asked to save a status report for troubleshooting purposes.</p>
Masks (Screens)	Shows additional diagnostic screens by selecting them in the dialog and pressing the confirmation button.

7.23 E-Multi Radial / Servo Carriage Screen

This screen is used to configure the carriage operating mode and carriage contact force on E-Radial and servo carriage systems. This screen does not appear for standard carriage models.

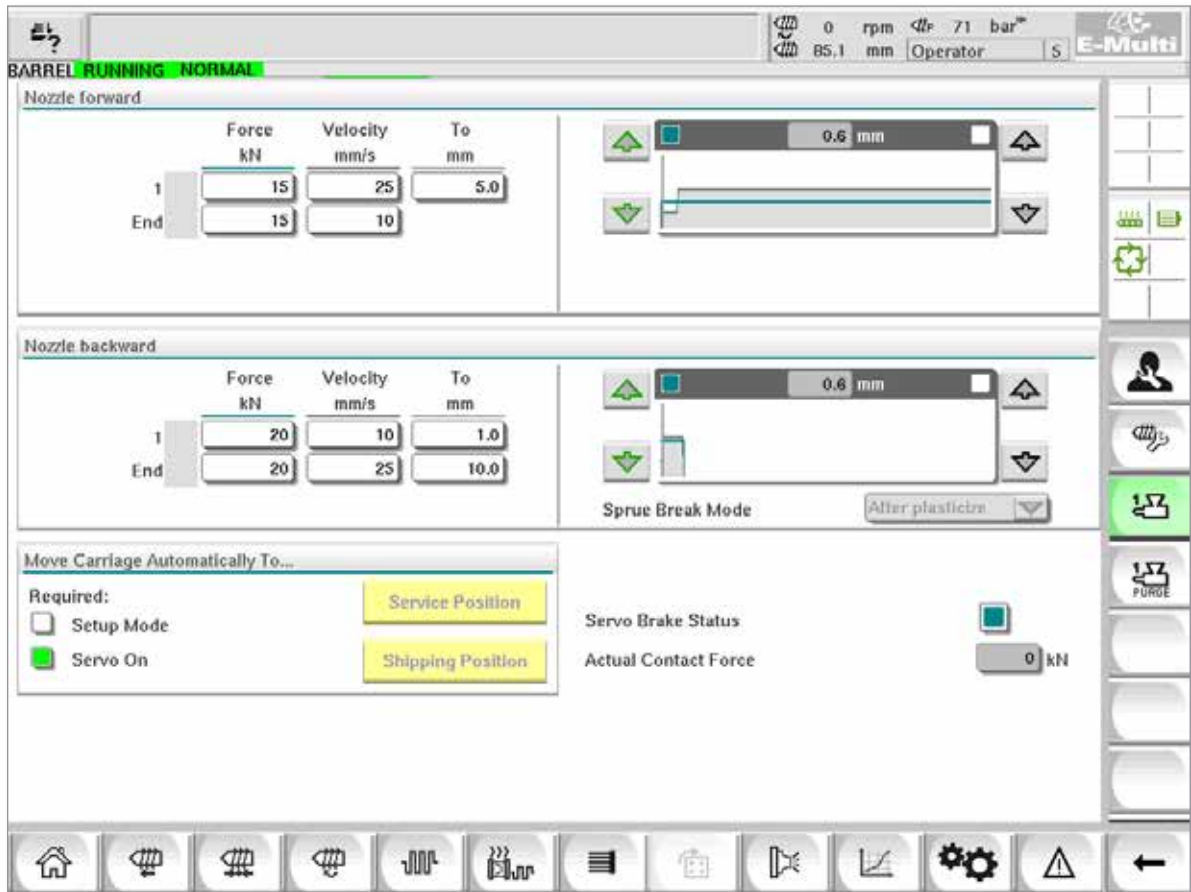
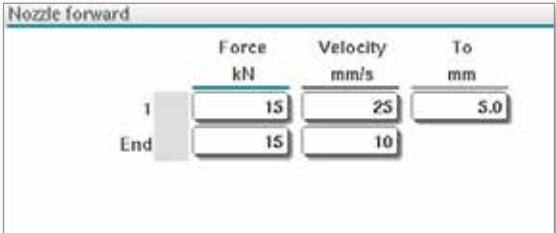

Figure 7-28 E-Multi Radial / Servo carriage screen

Table 7-38 E-Multi Radial / Servo Carriage Screen Components	
Screen Element	Description
<p>Nozzle Forward / Backward</p> <p>Pressure and Velocity Input Fields</p> 	<p>These settings can be adjusted by entering values directly into these fields.</p> <p>Used for setting the pressure and velocity of the nozzle during the cycle. The field labeled 1 controls the movement in the first stage, when the nozzle is moving towards the mold, and the field labeled end controls the nozzle movement when the nozzle is making contact with the mold.</p>

E-Multi Radial / Servo Carriage Screen - continued

Table 7-38 E-Multi Radial / Servo Carriage Screen Components	
Screen Element	Description
	<p>Pressure and Velocity Input Graph Alternatively, the <i>Pressure</i> (teal) and the <i>Velocity</i> (grey) values are shown in the form of profile graphs and the values can be adjusted using the arrow keys next to the profile graphs. On each click of the arrow, the profile graph is adjusted by +/-5 bar and/or +/-5%.</p> <p>Contact Force Displays current contact force to the mold.</p>
	<p>Nozzle back mode This selection indicates when the E-Multi Radial / Servo Carriage will move backward in the auto mode. There are 4 options: Maintain forward After inject after plasticize after cooling time</p>
	<p>Max. forward time Maximum time for the nozzle to reach contact force. If this time is exceeded an alarm will be raised and the cycle will be stopped.</p>
	<p>Max. backward time Maximum time for the nozzle to reach the sprue break position. If this time is exceeded an alarm will be raised and the cycle will be stopped.</p>

Table 7-39 E-Multi Radial / Servo Carriage Screen Context Menu Buttons	
	<p>Auto Purge See "Auto Purge Screen" on page 7-67.</p>

7.24 Auto Purge Screen

This screen is used to setup and activate the Auto Purge program for the E-Multi Radial / Servo carriage system.

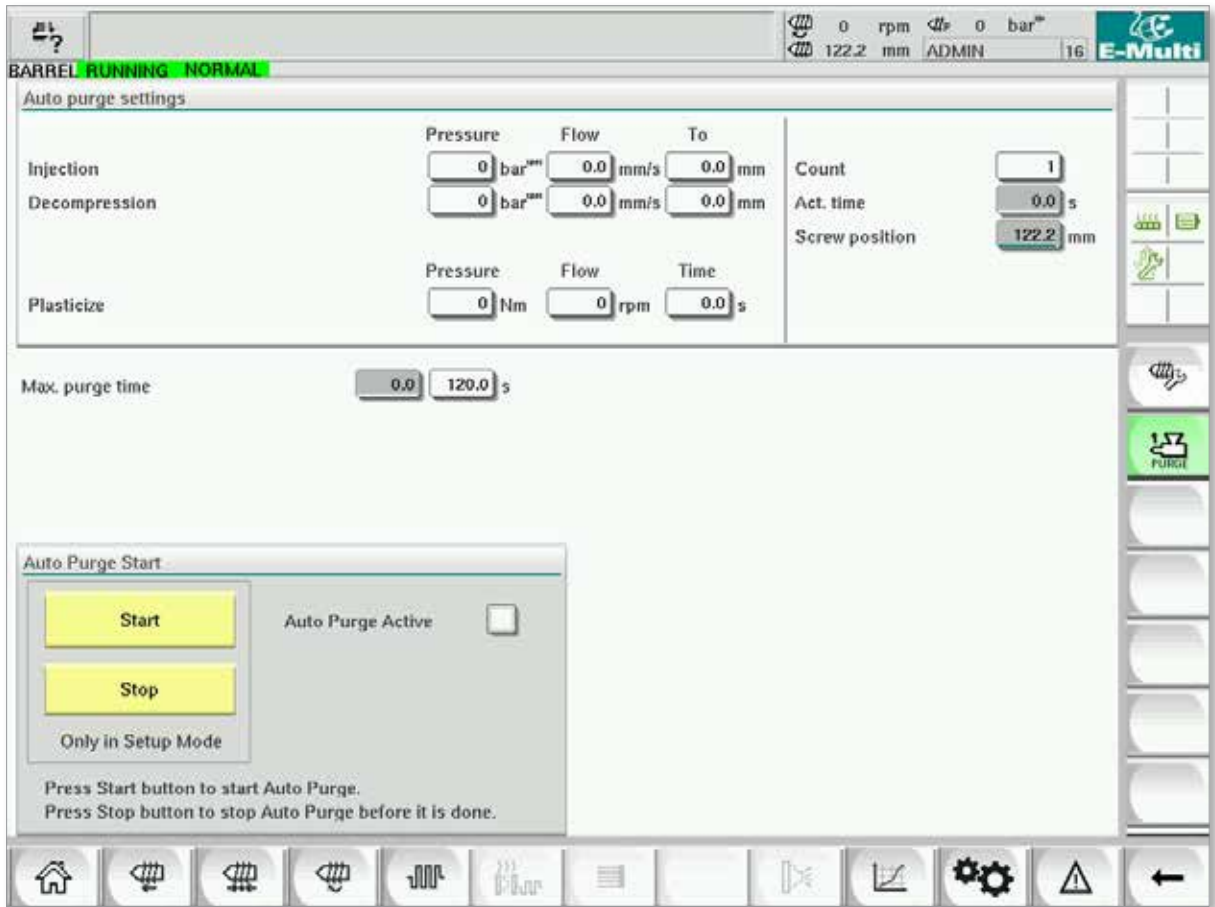

Figure 7-29 Auto purge screen

Auto Purge Screen - continued

Table 7-40 Auto Purge Screen Elements							
	<p>Auto Purge Settings</p> <p>Pressure and Velocity Input Fields These settings can be adjusted by entering values directly into these fields. These fields are used to set the purge cycle parameters.</p>						
	<table border="1"> <tr> <td>Count</td> <td>The number of times the purge cycle will run.</td> </tr> <tr> <td>Act. time</td> <td>Displays the duration of the last purge cycle</td> </tr> <tr> <td>Screw position</td> <td>Displays the current screw position.</td> </tr> </table>	Count	The number of times the purge cycle will run.	Act. time	Displays the duration of the last purge cycle	Screw position	Displays the current screw position.
Count	The number of times the purge cycle will run.						
Act. time	Displays the duration of the last purge cycle						
Screw position	Displays the current screw position.						
	<p>Max. purge time If the purge time exceeds this value, the cycle will stop and the machine will fault.</p>						
	<p>Auto Purge Start / Stop Pressing the 'Start' button will activate the Auto Purge program. Pressing the 'Stop' button will deactivate the Auto Purge process before it is complete.</p>						

7.25 Info-Log Screen

System events (alarms, user changes, system errors, etc.) are recorded in the Info log. This provides a history of the machine operation.

The Info-Log screen only displays information. Alarms cannot be confirmed here.

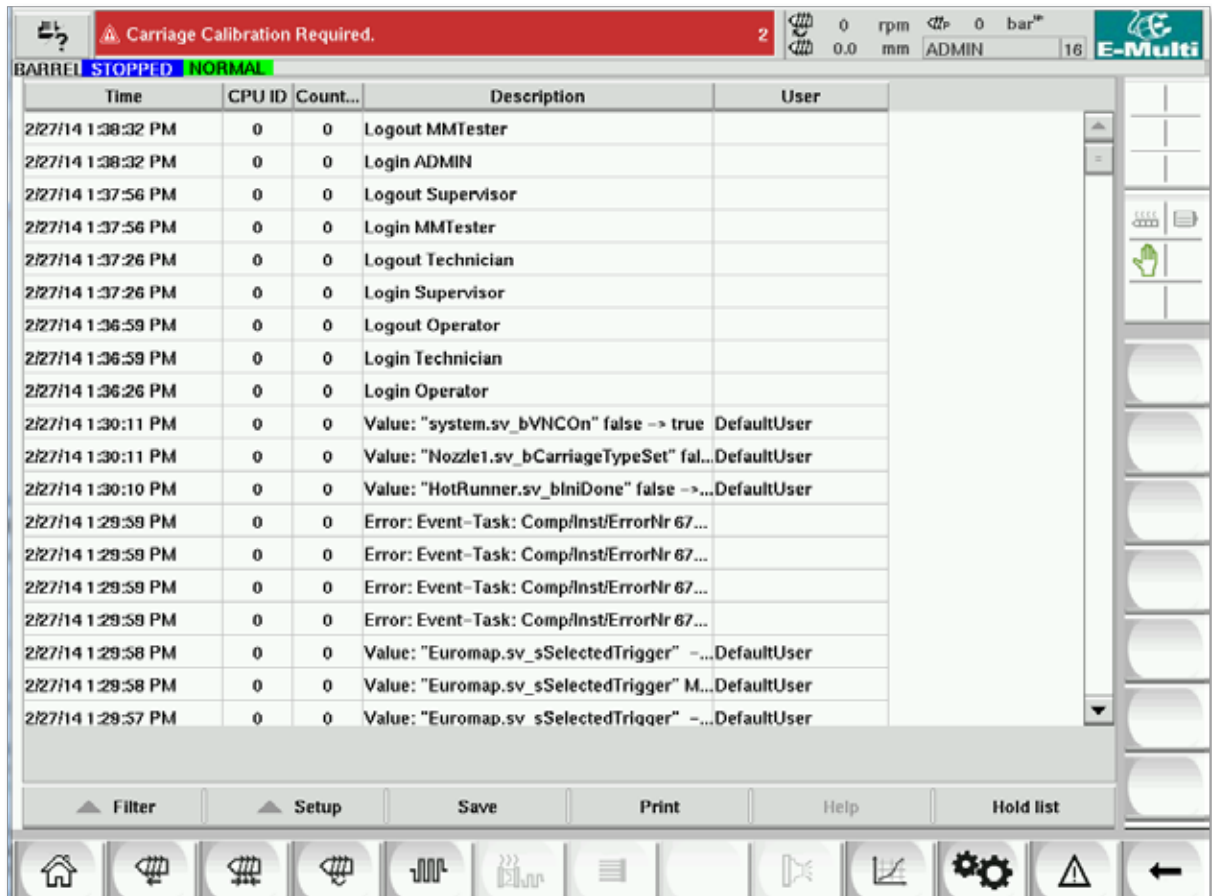

Figure 7-30 Info-log screen

Table 7-41 Info-Log Screen Elements

Interval: 1 Slot	Reference	Minimum	Maximum	Difference	Average
1390	6.15	92.255	434	518	518
1397	6.15	92.277	379	518	518
1398	6.30	92.705	395	520	520
1399	6.15	92.185	387	519	519
2030	6.01	92.275	437	520	520
2031	6.15	92.275	395	520	520
2032	5.90	92.278	423	521	521
2033	6.02	92.290	395	518	518
2034	6.33	92.270	397	519	519
2035	6.19	91.945	391	521	521
2036	6.10	91.914	439	520	520
2037	6.25	91.933	421	519	519
2038	6.30	91.937	411	520	520
2039	6.40	91.937	391	520	520
2040	6.15	91.929	423	520	520
2041	6.30	91.915	394	519	519

All system events are shown in the table. A status line underneath the table shows the entire text of the selected entry.

Using the menu bar, the entire info log may be saved or printed out.

The list may be limited to specific system events using the aid of a filter. This makes it easier to find entries.

Info-Log Screen - continued

Table 7-42 Info-Log Menu Buttons	
Filter	Allows a filter to be selected. Pressing the button restricts the display according to the filter settings. The filters for alarms, system, errors and application are predefined. By selecting filter off, all entries may again be displayed.
Setup	Independent filters may be defined via menu item Filter and the entries searched for text or time of occurrence. Also settings for the display of events may be made (display of long text, log file on and chronological display of events).
Save	The entire info log may be saved to a user selectable location.
View	Opens a sub menu for the selection of the following views: Compact: Only the connection designations and the status icons are displayed. Normal: The assigned system variable is displayed besides the connection designations and the status icons. List: Shows the connections in tabular form.
Print	Opens a printer-dialog and prints out the Info-Log. All currently displayed messages will be printed.
Help	Displays the corresponding help page for the selected line (help for the Info-Log class).

Table 7-43 Info-Log Filter Elements	
Check boxes (Alarm, System, etc.)	The corresponding Infolog class is displayed by selecting a check box. All Info-log classes are selected by default.
Find	The Info-Log entries are searched for the search term entered here and displayed with OK.
from / to	A specified time period may be entered in these input fields which restricts the Info-Log entries displayed.
OK	Confirm the entries.

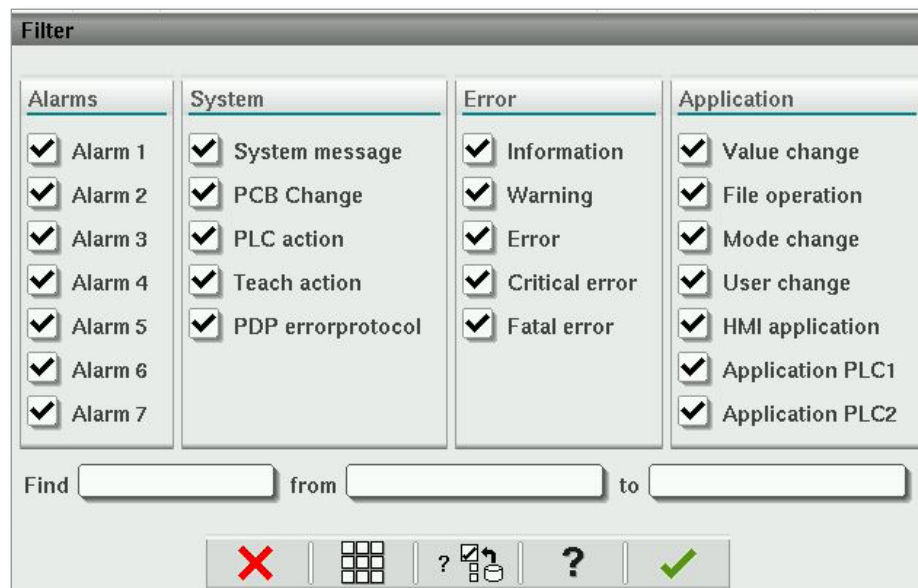

7.26 Programmable I/O

This section describes the settings for programmable digital outputs. For each output ON and OFF conditions can be defined. These conditions are defined using system variables.

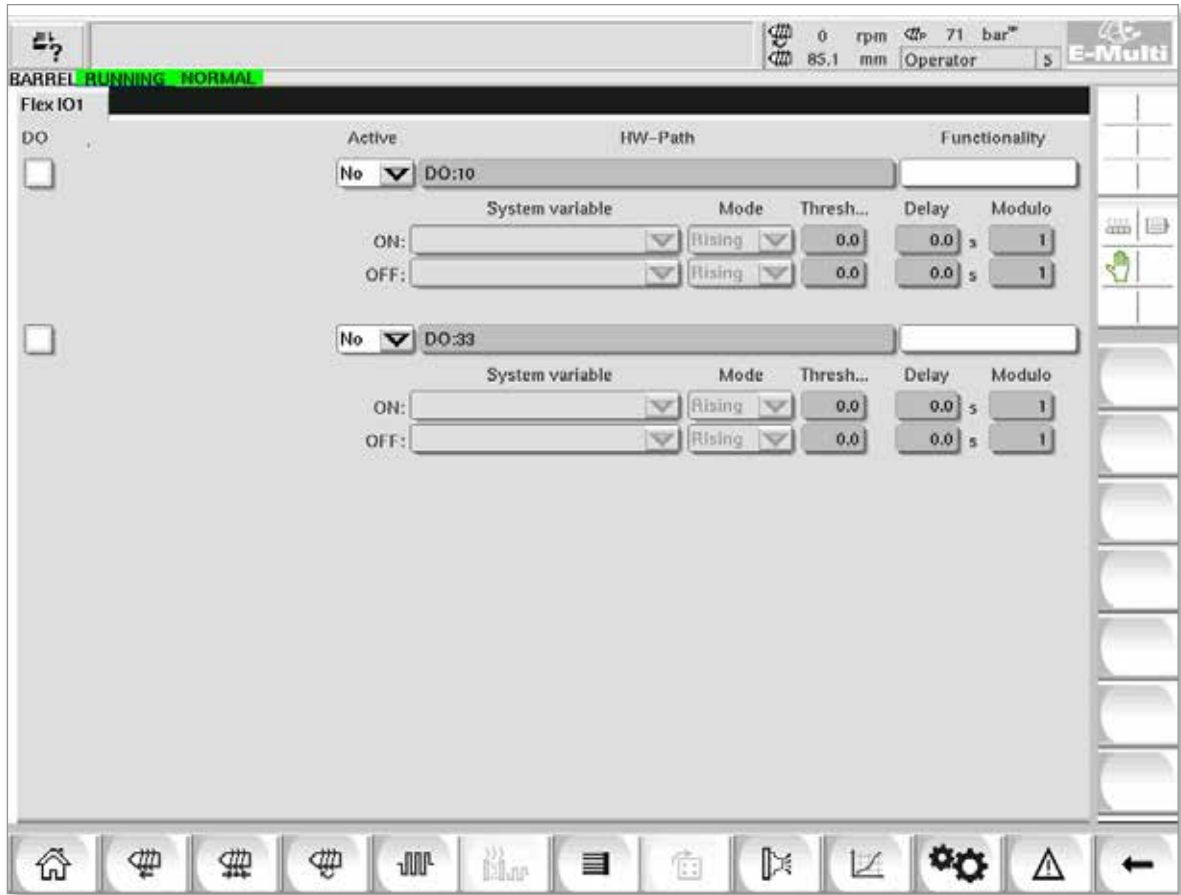

Figure 7-31 Programmable I/O screen

Table 7-44 Programmable I/O Screen Components	
Screen Components	Description
DO	Status of the digital output (active / inactive). The output is on when the box is filled.
Active	Defines if the programmable output is used or not.
HW-Path	Displays the PLC output being controlled
Functionality	Used to describe how the output is used, e.g. COLOR MIXER
System variable	Which variable will be used to turn the output on or off. The drop down list displays the variables in the IO Param variable group. Additional variables may be added as required.

Programmable I/O - continued

Table 7-44 Programmable I/O Screen Components	
Screen Components	Description
Mode	<p>Depending on the selected system variable, different settings are possible.</p> <p>Rising for flags and digital inputs and outputs</p> <ul style="list-style-type: none"> The digital output will be set or reset if the state of the variable changes from FALSE to TRUE or OFF to ON. <p>Rising for numbers and analog inputs and outputs</p> <ul style="list-style-type: none"> The digital output will be set or reset if the value of the system variable rises above a defined threshold. <p>Falling for flags and digital inputs and outputs</p> <ul style="list-style-type: none"> The digital output will be set / reset if the state of the variable changes from TRUE to FALSE or ON to OFF. <p>Falling for numbers or analog inputs and outputs</p> <ul style="list-style-type: none"> The digital output will be set / reset if the value of the system variable falls below a defined threshold. <p>Change</p> <ul style="list-style-type: none"> The digital output will be set / reset if the value of the system variable changes. Not available for decimal numbers or times.
Threshold	<p>Defines the threshold above or below which the output is turned on or off.</p> <p>Not available for flags and digital inputs or outputs.</p>
Delay	<p>Delay time between the on or off condition being fulfilled and the output being turned on or off.</p>
Modulo	<p>Defines how often a condition has to be fulfilled in order to turn the output on or off.</p> <p>A modulo of 2 on the ON condition would require the ON condition to be fulfilled 2 times before the output was turned on.</p>

7.26.1 I/O Monitor Screen

The I/O monitor screen displays the status of the inputs and outputs of the hardware modules.

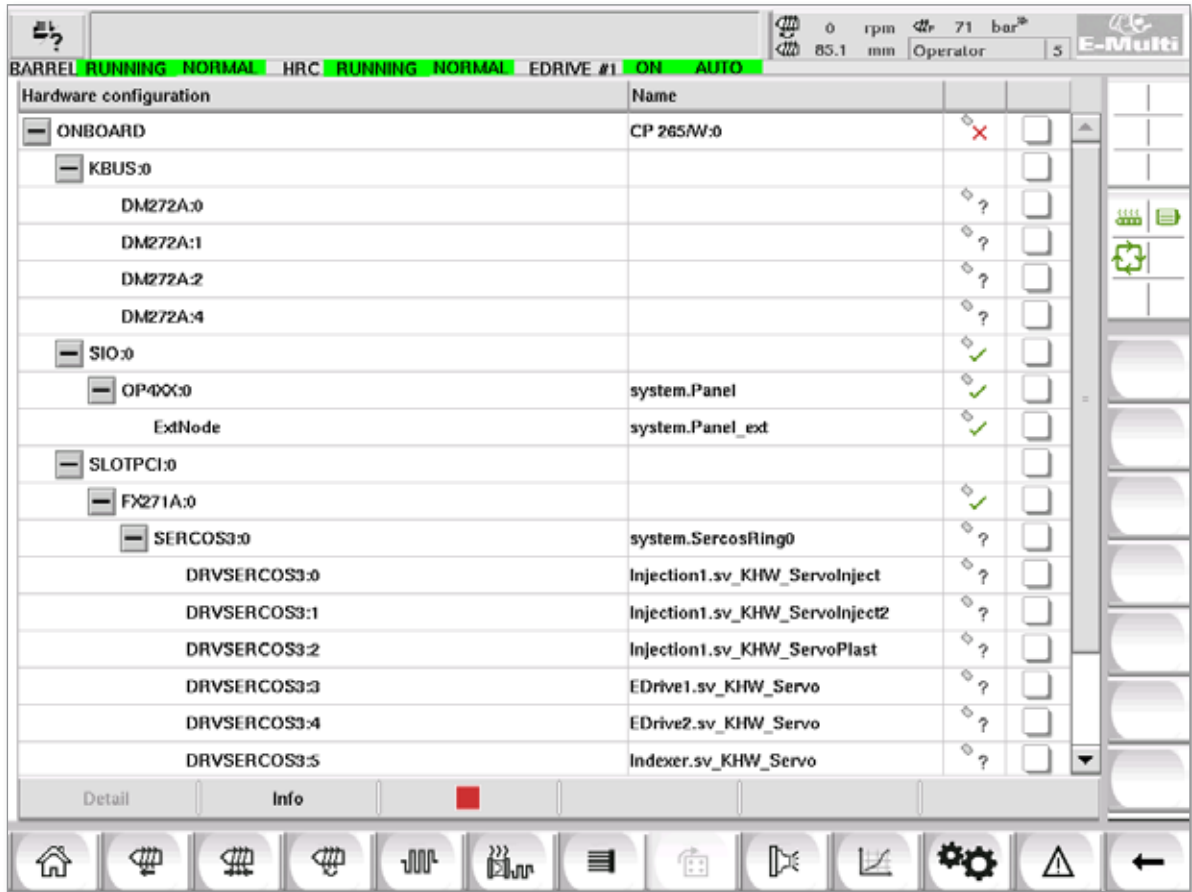

Figure 7-32 I/O monitor screen

Table 7-45 I/O Monitor Screen Components	
Screen Components	Description
Main overview screen	<p>The overview screen is used for the selection of one or more hardware modules. The modules are represented hierarchically in a tree structure, as they are integrated in the system (connections of CPU module via bus coupler, K-Net, K-CAN, SIO,... to the hardware modules).</p> <p>The modules required can be selected by clicking on the checkbox in the right column. Selecting one structure element will mark all elements located below.</p> <p>To deselect a module, click on it again.</p>
Info	This dialogue displays information about the selected module (e.g.: BIOS version, Operation hours counter, etc.).
Detail	Switches to the detail view of the selected module.
Start / Stop Indicator	<p>The state of the CPU is displayed as follows:</p> <ul style="list-style-type: none"> CPU is started. CPU is stopped.

7.27 Production Settings Screen

This screen offers settings for functions as well as display and setting options for the production process.

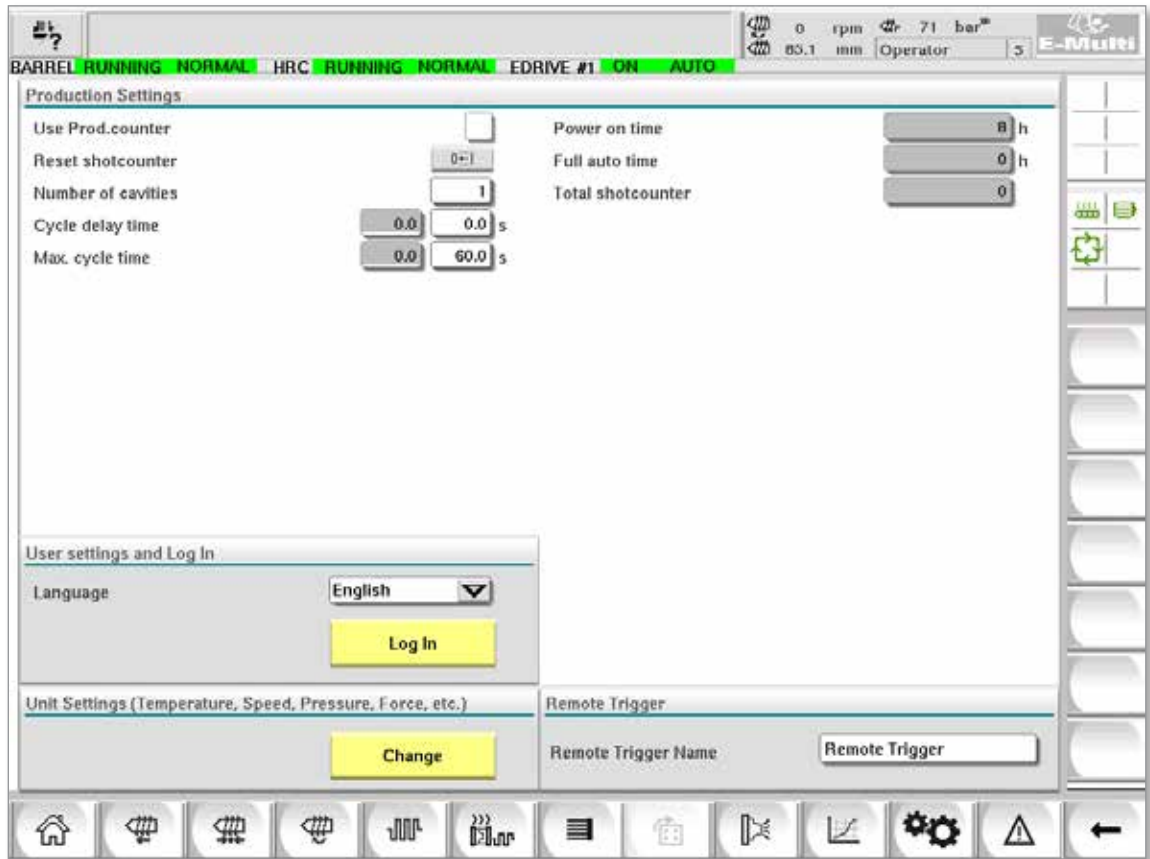

Figure 7-33 Production settings screen

Table 7-46 Production Settings Screen Components	
Screen Components	Description
Use Prod.counter	Activates / deactivates the use of the production counter limit on the home screen. See Overview screen.
Reset Shotcounter	Resets the production counter to 0.
Number of Cavities	Sets the number of cavities in the mold. The production counter is incremented by this amount every cycle.
Cycle Delay Time	Defines a delay time between production cycles in automatic mode.
Max. Cycle Time	In the left field (grey) the period of the current production cycle (in seconds) is shown. In the right field (white), the maximum cycle time can be set. If the production cycle exceeds this time, the process is stopped and an alarm is triggered.
Power On Time	Display of the machine's total runtime in hours.
Full Auto Time	Display of the machine's total runtime in automatic mode.
Total Shotcounter	Total shotcounter. Not resetable.
Language Combobox	Used to select the language displayed on all screens.
User Settings Button	Displays the user login dialog.
Unit Setup Button	Displays the measurement unit settings dialog. This dialog can be used to change the measurement units for the system and save or load custom unit templates.

7.28 Drive Monitor Screen

This screen shows the drive parameters (actual values) during live operation. The screen gives a simple overview of each drive in the system and helps with making an initial diagnosis in case problems occur on a drive. The screen shows information pertaining to the respective drive (Injection, Injection2, Plasticize, Carriage). Each drive is shown on a separate tab.

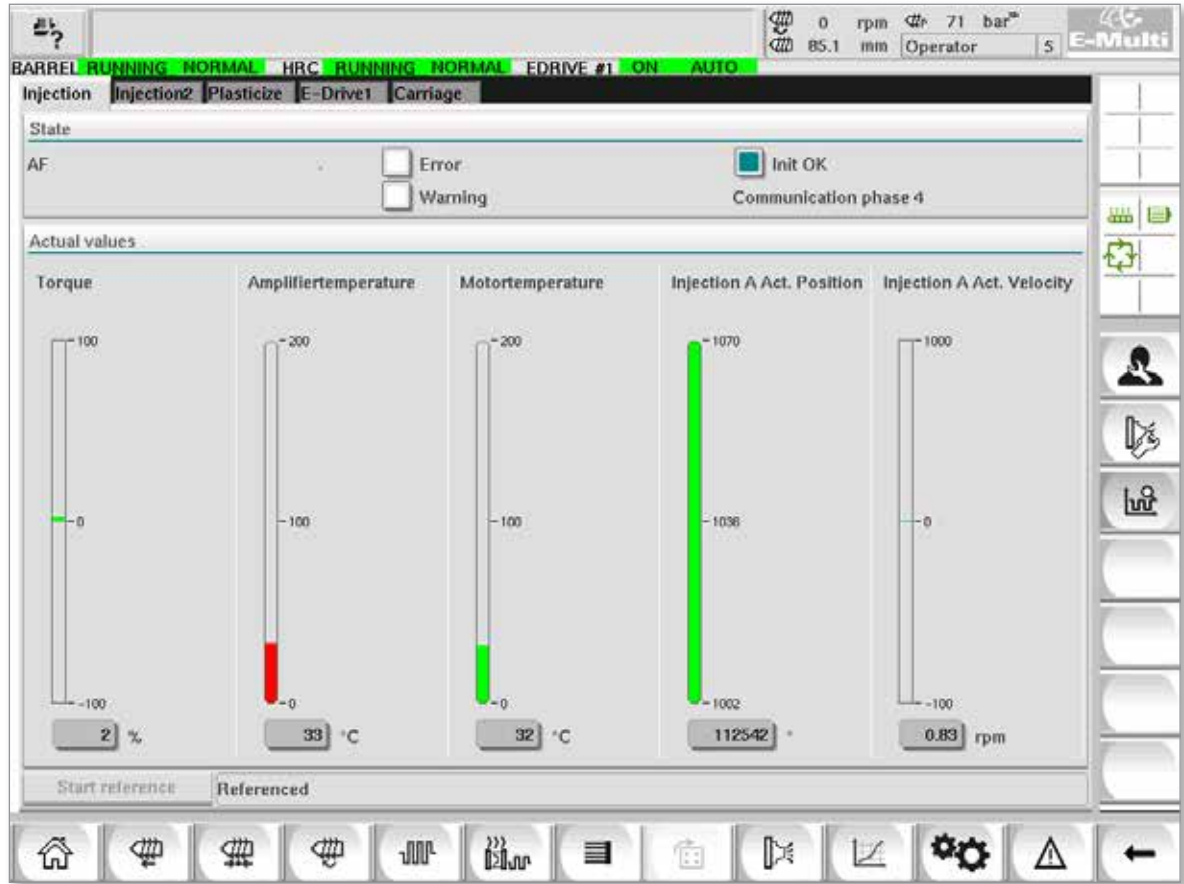

Figure 7-34 Drive monitor screen

Table 7-47 Drive Manager Screen Components

Screen Components	Description
State	Shows the drive states. Possible drive states: <ul style="list-style-type: none"> • AF = Drive enabled • Ab = Drive ready but not enabled • AH = Drive halt • bb = Drive ready but no 400 / 480VAC supply voltage. Check drive supply circuit breaker. • STO = Drive safety circuit open, check E-Stop and Gate circuits. • Fxxxx = Drive faulted (xxxx is the fault number)
Error	Indicates if the drive has an active fault. The fault is displayed in the alarm screen.
Warning	Display of a pending warning message for this drive. The warning message is displayed in the alarm screen.
Init OK	Initialization status of the drive (display only) <ul style="list-style-type: none"> • Green = Drive is initialized and ready for operation • Empty = Drive is not initialized / ready for operation

Drive Monitor Screen - continued

Table 7-47 Drive Manager Screen Components	
Screen Components	Description
Communication	<p>The communication phases (states) are shown on the right hand side in text form (e.g. Communication phase 4).</p> <ul style="list-style-type: none"> • 1, 2 or 3: Startup phase or parameter set transfer • 4: Cyclical mode OK
Torque	<p>Torque of the drive in percent of the maximum torque. The value is shown both graphically and numerically:</p> <ul style="list-style-type: none"> • Green = Normal range • Yellow = Warning range • Red = Critical range <p>The threshold values for the changing colors are defined in the drive configuration.</p>
Amplifier Temperature	<p>Temperature of the drive's performance component. The value is shown both graphically and numerically:</p> <ul style="list-style-type: none"> • Green = Normal range • Yellow = Warning range • Red = Critical range <p>The threshold values for the changing colors are defined in the drive configuration.</p>
Motor Temperature	<p>Temperature of the motor. The value is shown both graphically and numerically:</p> <ul style="list-style-type: none"> • Green = Normal range • Yellow = Warning range • Red = Critical range <p>The threshold values for the changing colors are defined in the drive configuration.</p>
Position	<p>Current position of the drive. The value is shown both graphically and numerically.</p>
Velocity	<p>Revolution velocity of the drive (unit: rpm). The value is shown both graphically and numerically.</p>
Start Reference Button	<p>Starts and / or stops the referencing of the drive. The current status of referencing is shown in a text line to the right of this button.</p>
Status Display	<p>The status display of the drive is to the right of the button Start referencing. The states are shown in text form, e.g. Referenced.</p>

7.29 Task Monitor Screen

This screen shows software tasks that are running in the background.

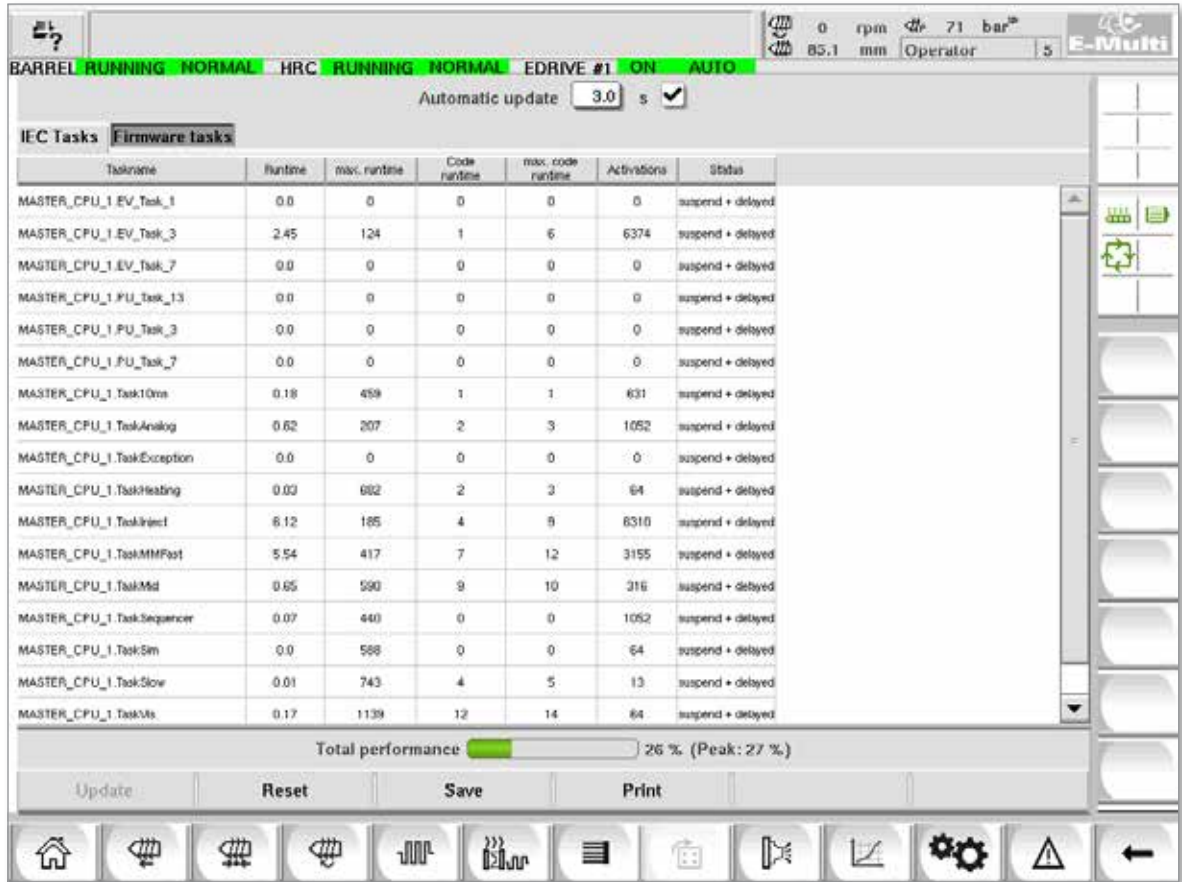

Figure 7-35 Task monitor screen

7.30 Drive Parameter Monitor Screen

Parameters of electrical drives may be displayed in this screen and their values changed. The left part of the screen shows the existing drives in a tree structure. By expanding the structure, the individual parameter groups may be selected. The right part of the screen shows the parameters of selected groups in tabular form.

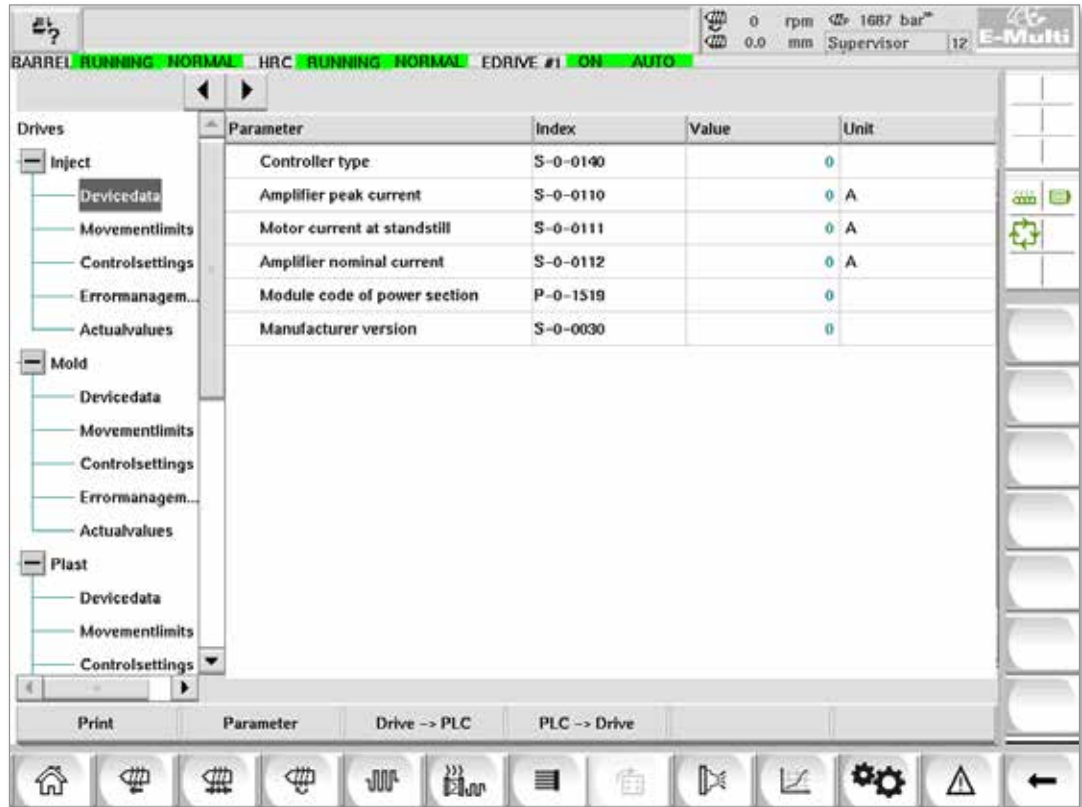

Figure 7-36 Drive parameter monitor screen

Table 7-48 Drive Parameter Monitor Screen Components	
Screen Components	Description
Parameter (Column)	Designation of the parameter. If the parameter is an array, the structure may be expanded with the [+] button that is in the same line.
Index	Unique index of the parameters (including Sub-Index).
Value	Value of the parameter.
Unit	Unit of the parameter.
Menu Buttons	
Print	Printout of the displayed parameters.
Parameter	This button is used to open a dialog for the direct display of a parameter (Parameter selection).
Drive -> SPS	The entire parameter set of the selected drive may be stored in a file (*.vda) here. The file name can also be specified besides the storage location.
SPS -> Drive	The entire parameter set from a file (*.vda) may be loaded into the selected drive here.

7.31 PID Settings



CAUTION

Modifying PID values can cause damage to the injection unit that is not covered under warranty.

Record the original values before making changes.

Change values one at a time and in small steps.

For P, the larger the value, the greater the effect.

For I, the smaller the value, the greater the effect.

Table 7-49 PID Settings Screen Components

Screen Components	Description	
Inject pressure limit	Use Inject Pressure Limit PID	When this option is selected, the pressure limit is regulated (PID), otherwise it will be controlled.
	P	The proportional part for the injection regulator is adjusted here.
	I	The integral part for the injection regulator is adjusted here.
	D	The differential part for the injection regulator is adjusted here.
Pressure limit controller	Use Inject Pressure Limit Velocity	When this option is selected, the injection is regulated (PID), otherwise it will be controlled.
	P	The proportional part for the pressure limit controller is adjusted here.
	I	The integral part for the pressure limit controller is adjusted here.
	D	The differential part for the pressure limit controller is adjusted here.
Hold	Use hold PID	When this option is selected, the hold pressure is regulated (PID), otherwise it will be controlled.
	P	The proportional part for the hold pressure controller is adjusted here.
	I	The integral part for the hold pressure controller is adjusted here.
	D	The differential part for the hold pressure controller is adjusted here.
Backpressure	Use backpressure PID	When this option is selected, the backpressure at plasticizing is regulated (PID), otherwise it will be controlled. Precondition for control: Oil backflow at linear screw movement in backward direction must be throttled by an electromagnetically activated proportional valve.
	P	The proportional part for the back pressure at plasticizing is adjusted here.
	I	The integral part for the back pressure at plasticizing is adjusted here.
	D	The differential part for the back pressure at plasticizing is adjusted here.

7.32 Reference Settings Screen

This screen shows all of the reference values set for the E-Multi system.

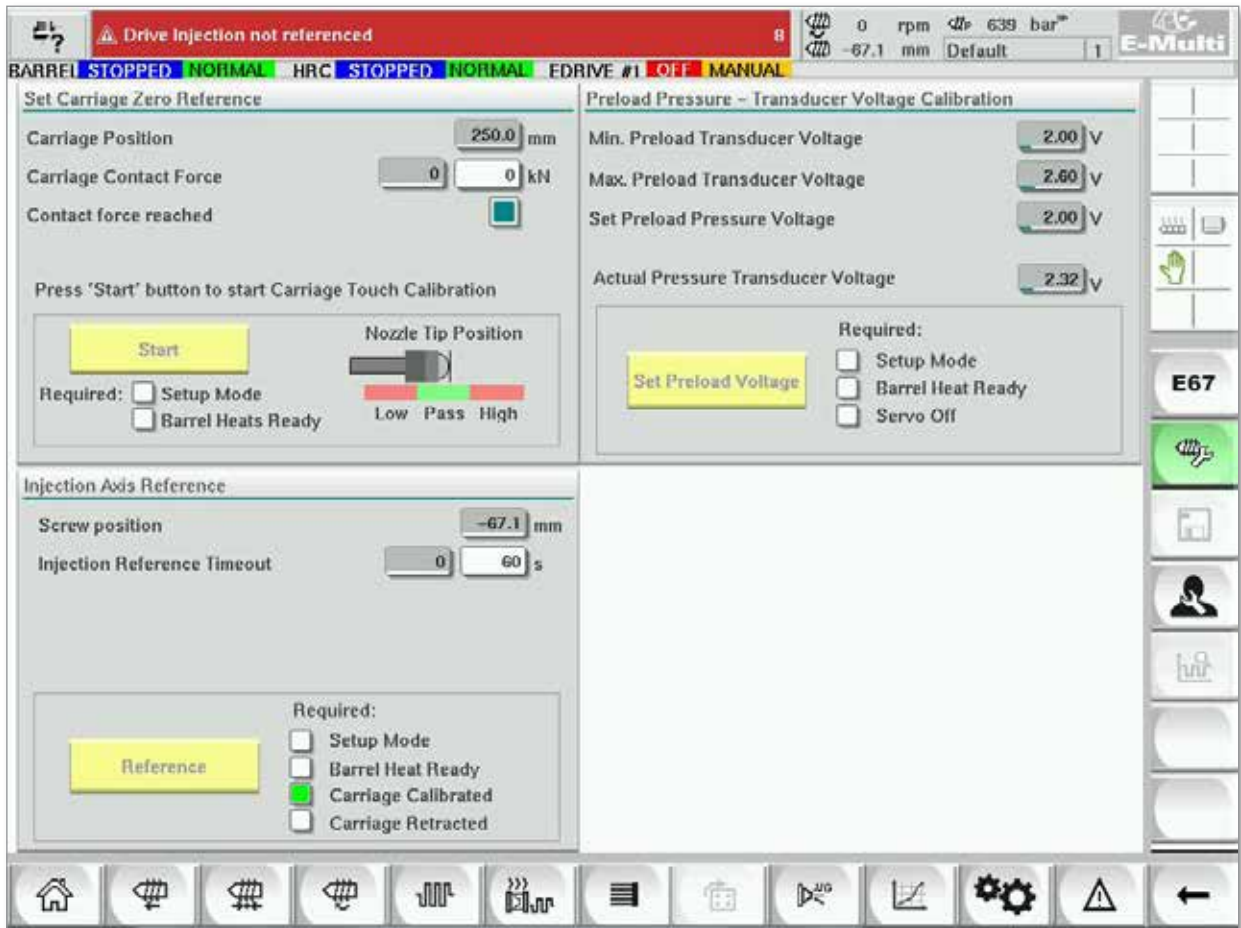

Figure 7-37 Reference settings screen

Table 7-50 Reference Settings Screen Elements

Screen Component	Description	
	Carriage Position	Relative position of the nozzle to mold inlet.
	Contract Force Set	The left field, with the grey background, shows the current nozzle force. The right field, with a white background, shows the contact force set point.
	Contact force reached	It is an indicator to acknowledge the nozzle contact force has reached the set point.
	Set Carriage Zero Reference	This is used during the carriage setup and is only visible in setup mode. Tap the button to reset the nozzle position to 0 when the nozzle is just touching the nozzle inlet on the mold.

7.32.1 Reference Settings Screen - continued

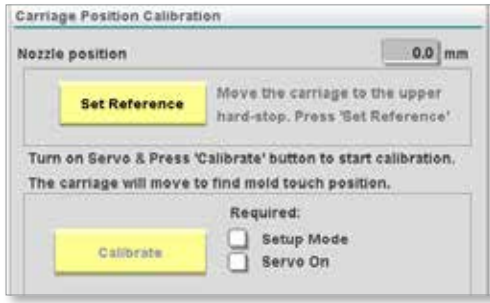
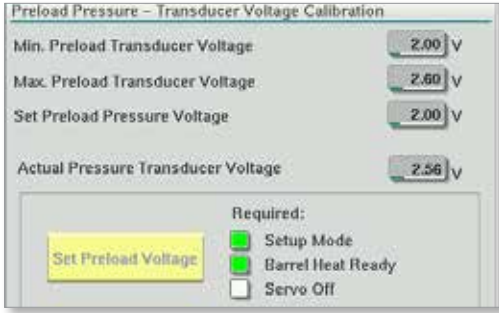
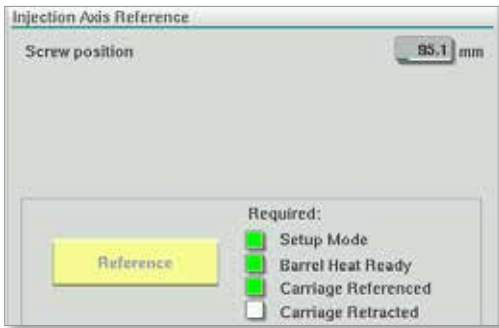



Table 7-50 Reference Settings Screen Elements											
Screen Component	Description										
	<p>E-Multi Radial and Servo Carriage options This frame replaces the Set Carriage Zero Reference frame when an E-Multi Radial unit is installed.</p>										
	<table border="1"> <tr> <td>Calibrate</td> <td>Begins the auto calibration routine for the E-Multi Radial.</td> </tr> <tr> <td>Set Reference</td> <td>The controller must be in Setup mode. Use the F3 button to move the carriage away from the mold until it stops moving. Tap the Set Reference button to set the nozzle back reference position.</td> </tr> </table>	Calibrate	Begins the auto calibration routine for the E-Multi Radial.	Set Reference	The controller must be in Setup mode. Use the F3 button to move the carriage away from the mold until it stops moving. Tap the Set Reference button to set the nozzle back reference position.						
Calibrate	Begins the auto calibration routine for the E-Multi Radial.										
Set Reference	The controller must be in Setup mode. Use the F3 button to move the carriage away from the mold until it stops moving. Tap the Set Reference button to set the nozzle back reference position.										
	<p>Preload Pressure - transducer voltage calibration</p>										
	<table border="1"> <tr> <td>Minimum Preload Transducer Voltage</td> <td>If the pressure transducer voltage drops below this value, an alarm will be generated.</td> </tr> <tr> <td>Maximum Preload Transducer Voltage</td> <td>If the pressure transducer voltage at idle rises above this limit, an alarm will be generated.</td> </tr> <tr> <td>Set Preload Voltage</td> <td>Pressure transducer voltage that corresponds to 0 melt pressure.</td> </tr> <tr> <td>Actual Pressure Transducer Voltage</td> <td>Real time pressure transducer voltage reading.</td> </tr> <tr> <td>Set Preload Voltage Button</td> <td>Sets the transducer voltage that corresponds to 0 melt pressure.</td> </tr> </table>	Minimum Preload Transducer Voltage	If the pressure transducer voltage drops below this value, an alarm will be generated.	Maximum Preload Transducer Voltage	If the pressure transducer voltage at idle rises above this limit, an alarm will be generated.	Set Preload Voltage	Pressure transducer voltage that corresponds to 0 melt pressure.	Actual Pressure Transducer Voltage	Real time pressure transducer voltage reading.	Set Preload Voltage Button	Sets the transducer voltage that corresponds to 0 melt pressure.
	Minimum Preload Transducer Voltage	If the pressure transducer voltage drops below this value, an alarm will be generated.									
	Maximum Preload Transducer Voltage	If the pressure transducer voltage at idle rises above this limit, an alarm will be generated.									
	Set Preload Voltage	Pressure transducer voltage that corresponds to 0 melt pressure.									
	Actual Pressure Transducer Voltage	Real time pressure transducer voltage reading.									
Set Preload Voltage Button	Sets the transducer voltage that corresponds to 0 melt pressure.										
<p>Injection Axis Reference</p>											
	<table border="1"> <tr> <td>Screw Position</td> <td>Specifies the screw position at which the system changes to hold pressure</td> </tr> <tr> <td>Reference Button</td> <td>Tap this button to automatically move the screw fully back and then fully forward to verify the stroke and reset the screw 0 position. CAUTION: The injection unit will move once this choice is confirmed. Note: Referencing should be done with no material in the feed block to prevent material bridging.</td> </tr> </table>	Screw Position	Specifies the screw position at which the system changes to hold pressure	Reference Button	Tap this button to automatically move the screw fully back and then fully forward to verify the stroke and reset the screw 0 position. CAUTION: The injection unit will move once this choice is confirmed. Note: Referencing should be done with no material in the feed block to prevent material bridging.						
	Screw Position	Specifies the screw position at which the system changes to hold pressure									
Reference Button	Tap this button to automatically move the screw fully back and then fully forward to verify the stroke and reset the screw 0 position. CAUTION: The injection unit will move once this choice is confirmed. Note: Referencing should be done with no material in the feed block to prevent material bridging.										
											

Table 7-51 Reference Settings Screen Context Menu Buttons	
	<p>Production Graph Configurable view</p>
	<p>Production Settings</p>

7.33 Machine Data Screen

Used for backing up (saving) machine parameters before a software update and restoring (loading) saved machine parameters after a software update.

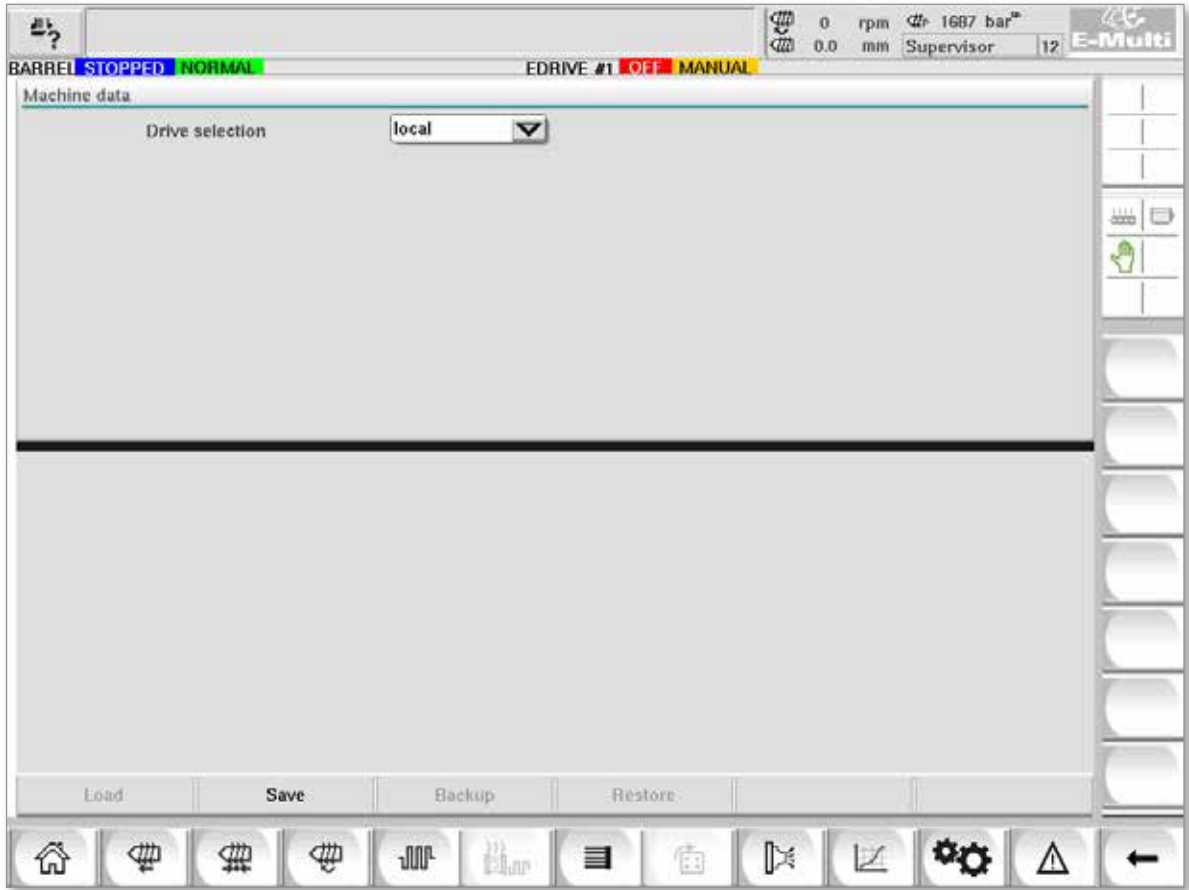

Figure 7-38 Machine data screen

Table 7-52 Machine Data Screen Components	
Screen Components	Description
Drive selection Drop Down Menu	Location where the machine data will be saved to or loaded from.
Load	Restores (loads) machine parameters from a previously backed up dataset. Saved datasets can be loaded from the CF Card or USB stick.
Save	Saves the current machine parameters to a backup dataset on the CF card or USB stick.
Backup	Backs up the saved machine file as backup. This button is only available if machine data has already been saved.
Restore Backup	Restores the saved machine file. This button is only available if a backup is available.

7.34 Variable Monitor Screen



CAUTION

Changing system variables may result in unexpected operation and damage to the E-Multi that is not covered under warranty.

The variable monitor screen is used for viewing and modifying machine (IEC) variables. The user may put together any variables in groups, save, observe or modify the value of the variables group. This service screen is mainly used for fault diagnosis and startup. The variables monitor consists of three sections (tabs):

- Variable selection, for grouping of variables
- Variable list, for displaying selected variables
- Search result

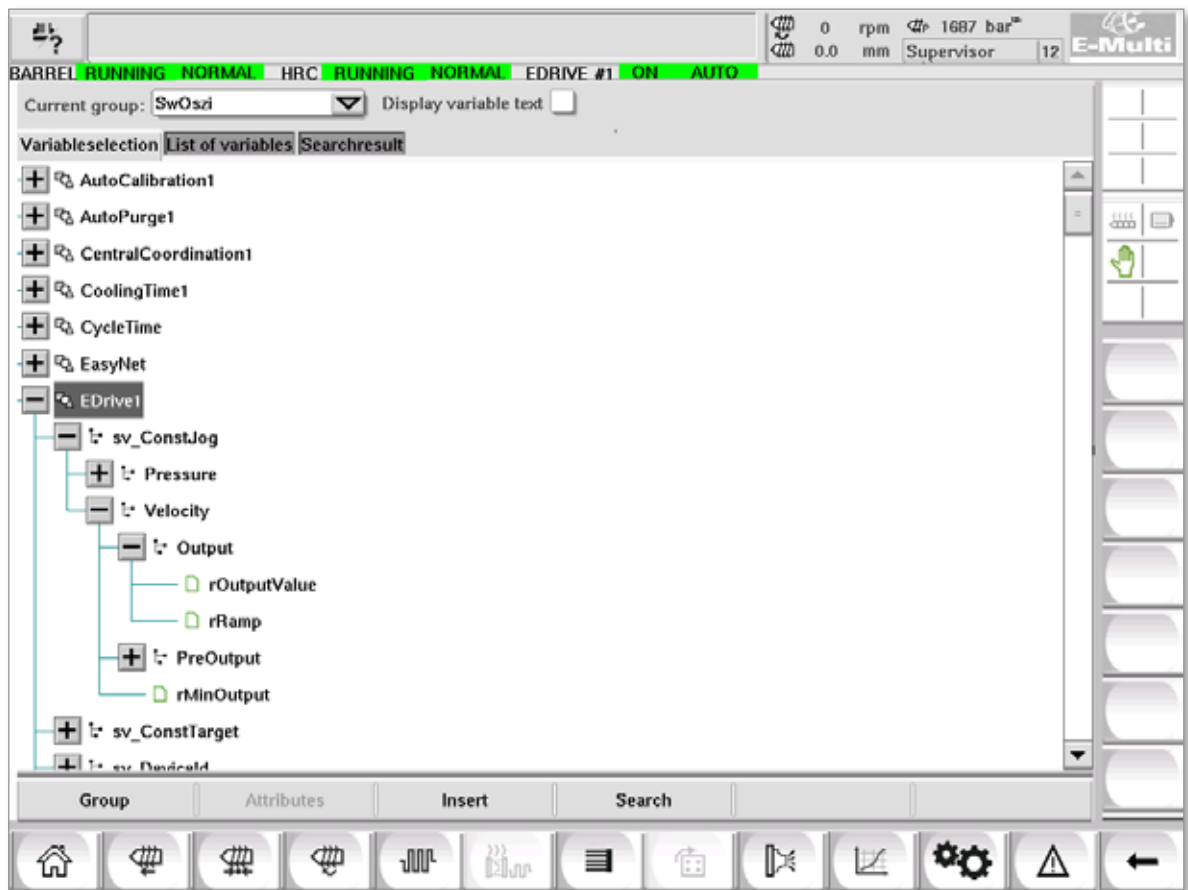

Figure 7-39 Variable monitor screen

Variable Monitor Screen - continued

Table 7-53 Variable Monitor Screen Components	
Screen Components	Description
Variable Selection	Displays all system variables in a tree format. These may be expanded and all variables, structures and arrays contained within may be displayed. In the variables selection any variables may be chosen for display in the variable list. Additionally the variables may be organized in groups.
List of Variables	Displays the variables in the chosen variable group.
Search Result	The search result is displayed in this area. The current machine unit and the specified search term is displayed above the result. The search result remains until the next search process is received.
Menu Buttons	
Current Group	Displays a list of the available variable groups. Making a selection from this list will update the variables shown on the list of variables tab.
Group	This button opens a pop-up menu where the following functions may be selected: <ul style="list-style-type: none"> • New: Creates a new group • Delete: Deletes the currently selected group • Save: Saves the currently selected group • Restore: Restores the selected variable group The created group is also used for variable selection in PDProtocol, PDGraphic and PDSupervision.
Attributes	The attributes for the selected variable are displayed in a dialog.
Insert	The selected variable is added to the currently selected group. If a structure is selected, only the base elements of the next level of this structure are added with Insert. These variables will be inserted into the current group.
Search	After selecting an element (machine unit, structure, etc.), a dialog in which a search can be made for system variables within the selected element can be opened with this button. With this, the name, long text, short text or the unit of the variable(s) being searched for can be specified (multiple specifications are linked with AND). The search result is displayed under Search result. Variables out of this list can be added to a group with the Insert button.
List of Variables Tab - Additional Fields	
Name / long text	The name of the variable including path is displayed here. If the variable name is longer than the column width, it is truncated in the middle with "...". The full name is displayed in the status line when it is selected. The long text is displayed with the option Display Variable Text.
Value	Displays the value of the variable. The value can be modified directly.
Unit	Unit of the variable.

7.35 Delay Settings Screen

This screen is used to set delay times for the production operation. Delay times adjusted in this screen only affect the manual and full automatic mode. These settings have no effect on setup mode.

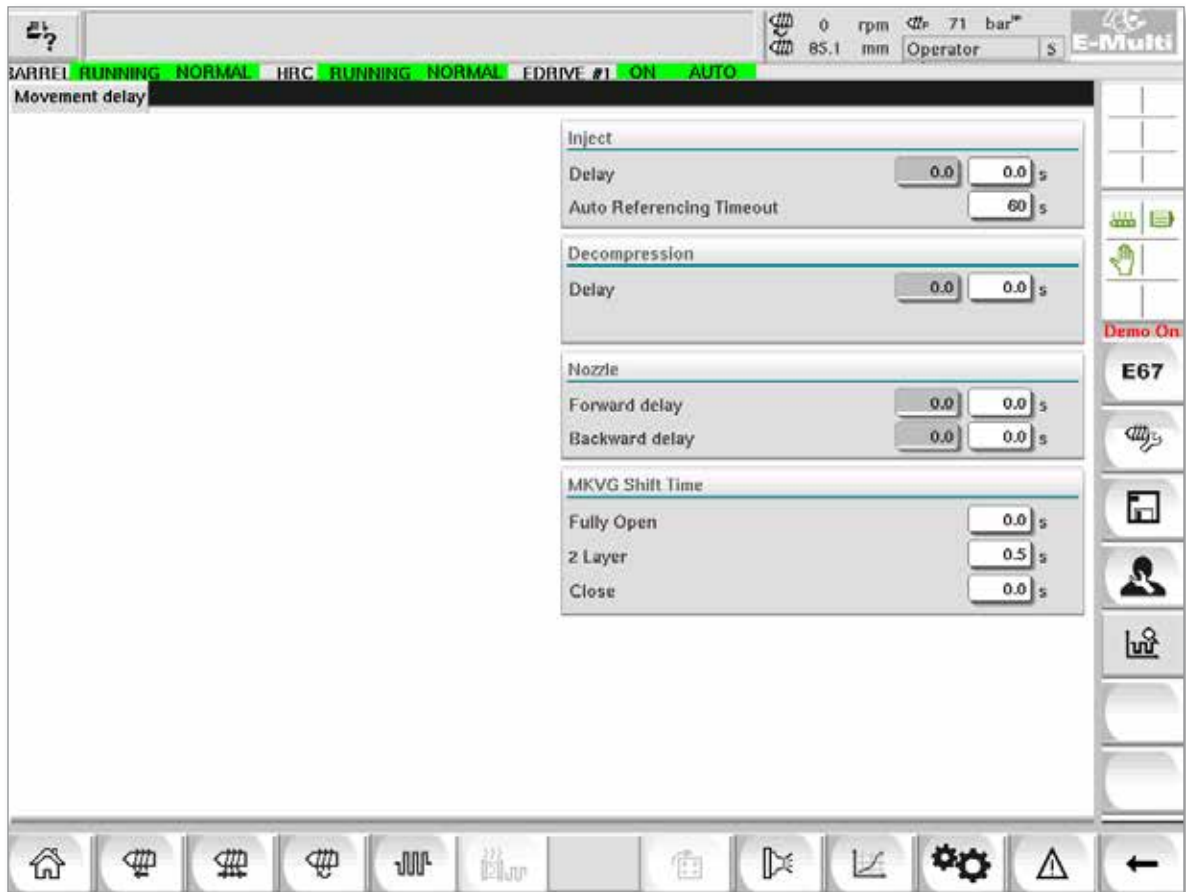

Figure 7-40 Delay settings screen

Table 7-54 Delay Setting Screen Components	
Screen Components	Description
Inject: Delay	Delay time between carriage force being reached and the start of injection. If the nozzle is already forward this delay will still be added. Recommended for use with sprue break only.
Decompression: Delay	Delay time before nozzle is moved away from the mold.
Nozzle: Forward Delay	The duration between the plasticizing and the start of the nozzle's forward movement is specified here.
Backward Delay	The duration between the end of injecting and the start of the nozzle's backward movement is specified here.

7.36 Calibration Settings Screens

These screens are used for calibration of machine transducers, servo degrees to distances, etc.

This screen is divided into the following tabs:

- Nozzle (only for servo carriage systems)
- Injection
- RPM and Inject press

The table shows the values of the individual stages, where they may also be changed manually. The linearization table is displayed on the right.

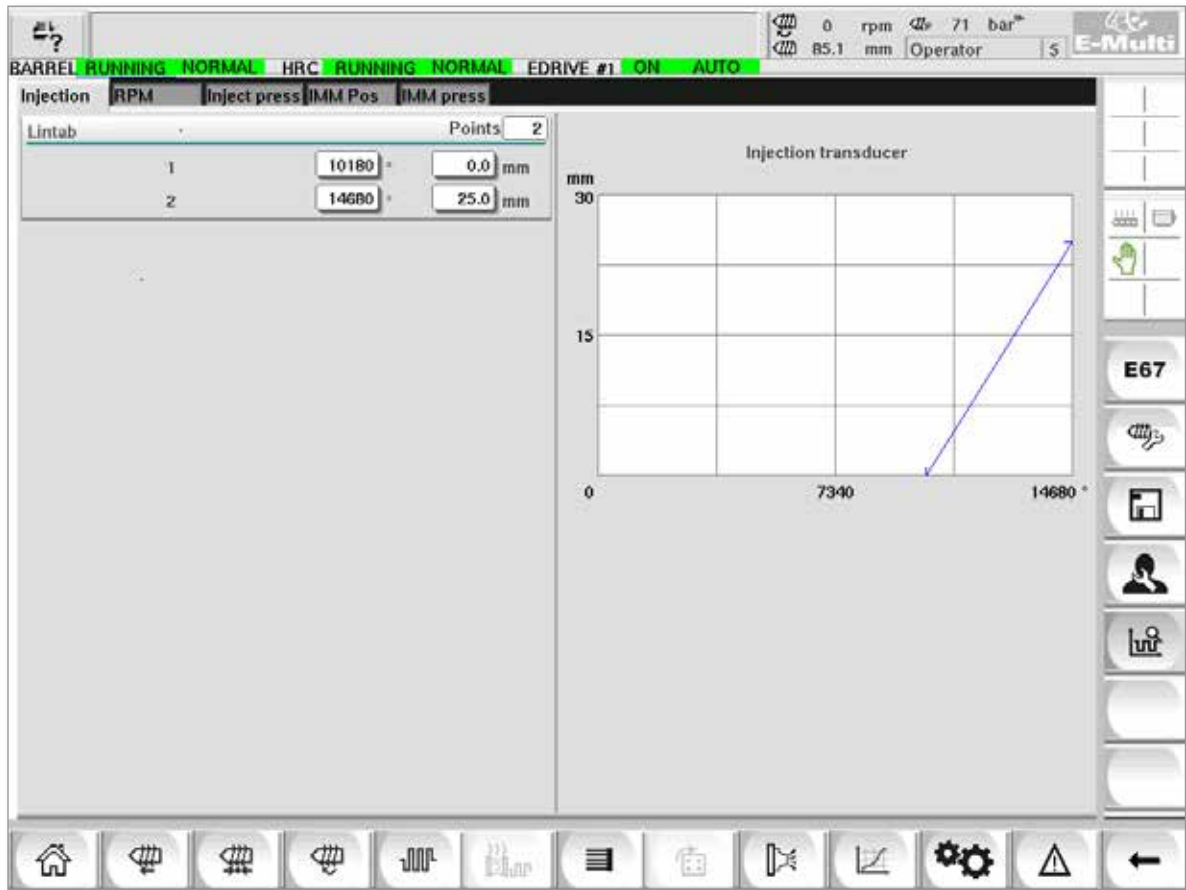

Figure 7-41 Calibration settings screen

Table 7-55 Calibration Settings Screen Components	
Screen Components	Description
Nozzle	This tab is used for the calibration of carriage feedback to actual carriage position.
Injection	This tab is used for the calibration of injection motor's rotary position to the screw position.
RPM	This tab is used for the calibration of the screw motor's rotational speed to the feed screw's rotational speed.
Inject Press	This tab is used for calibrating the machine's injection pressure.
	Lintab Points Number of points in the linearization table.
	1 - n After the auto calibration, the values determined in the process will be entered automatically into these fields. All values can be subsequently changed by manual entry.

7.37 Alarms Screen

The alarm screen shows a list of the alarms triggered by the control including status, time of occurrence, alarm class and description. Alarms can be confirmed either individually or collectively via the menu bar.

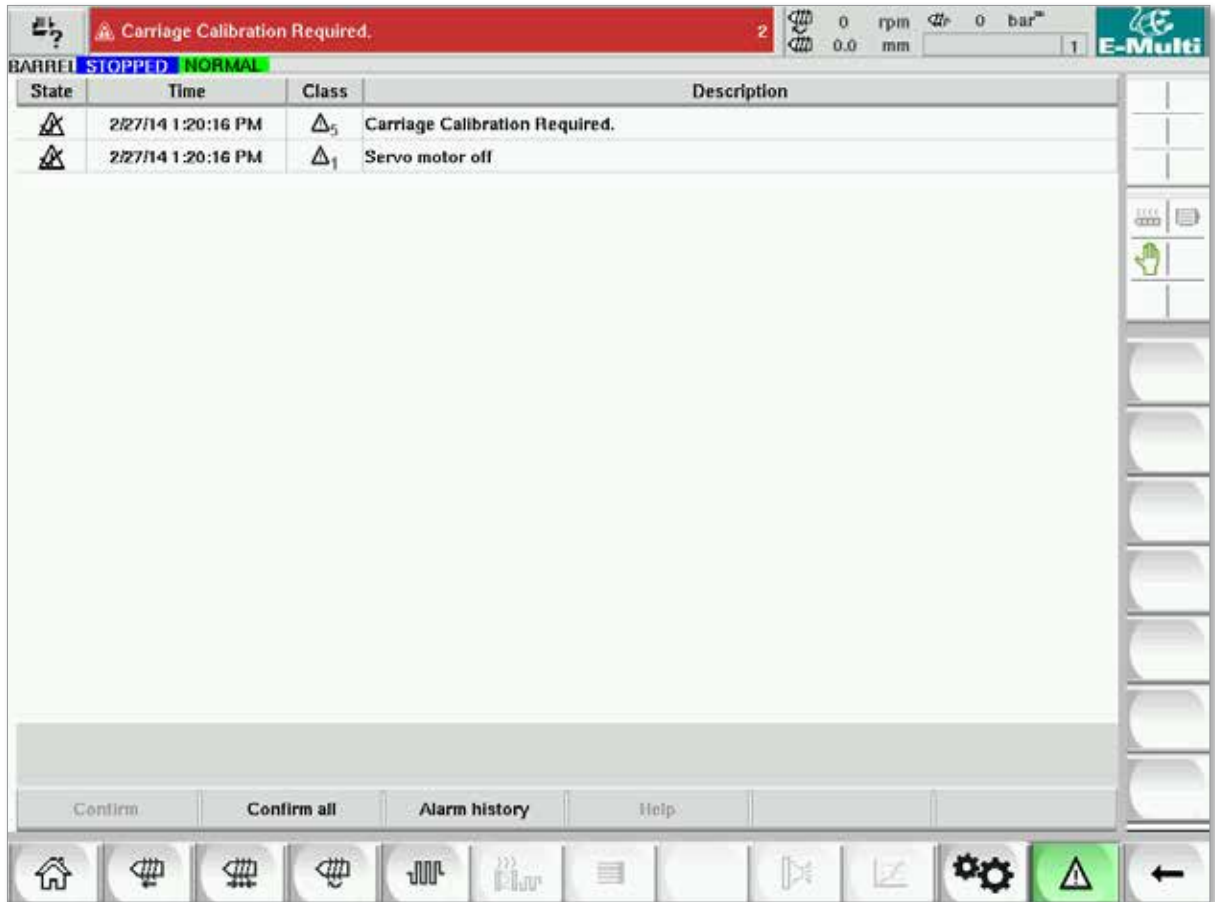

Figure 7-42 Alarms screen

Alarms Screen - continued

Table 7-56 Alarms Screen Components

Screen Components																																															
<table border="1"> <thead> <tr> <th>State</th> <th>Time</th> <th>Class</th> <th>Description</th> </tr> </thead> <tbody> <tr> <td></td> <td>11/6/13 2:20:45 PM</td> <td>▲</td> <td>Drive E-Drive1 not initialized</td> </tr> <tr> <td></td> <td>11/6/13 2:20:35 PM</td> <td>▲₁</td> <td>HRC Ready Interlock is not ON. Check HRC temperatures and r</td> </tr> <tr> <td></td> <td>11/6/13 2:20:35 PM</td> <td>▲₂</td> <td>EDrive Plate# 1 : Servo is not Enabled.</td> </tr> <tr> <td></td> <td>11/6/13 2:20:35 PM</td> <td>▲₃</td> <td>Nozzle not referenced</td> </tr> <tr> <td></td> <td>11/6/13 2:20:34 PM</td> <td>▲₂</td> <td>EDrive Plate# 1 : Homing is required</td> </tr> <tr> <td></td> <td>11/6/13 2:20:34 PM</td> <td>▲₂</td> <td>EDrive Plate# 1 : is not in Auto Mode. This blocks the E67 Robot.</td> </tr> </tbody> </table>	State	Time	Class	Description		11/6/13 2:20:45 PM	▲	Drive E-Drive1 not initialized		11/6/13 2:20:35 PM	▲ ₁	HRC Ready Interlock is not ON. Check HRC temperatures and r		11/6/13 2:20:35 PM	▲ ₂	EDrive Plate# 1 : Servo is not Enabled.		11/6/13 2:20:35 PM	▲ ₃	Nozzle not referenced		11/6/13 2:20:34 PM	▲ ₂	EDrive Plate# 1 : Homing is required		11/6/13 2:20:34 PM	▲ ₂	EDrive Plate# 1 : is not in Auto Mode. This blocks the E67 Robot.	<table border="1"> <thead> <tr> <th>Column</th> <th colspan="2">Description</th> </tr> </thead> <tbody> <tr> <td>State</td> <td colspan="2">The column shows the status icon of the alarm</td> </tr> <tr> <td></td> <td>Active</td> <td>Pending alarm</td> </tr> <tr> <td></td> <td>Inactive</td> <td>Alarm is reset by the application, but not yet acknowledged by the user</td> </tr> <tr> <td></td> <td>Confirmed</td> <td>The alarm has been acknowledged by the user, but has not been reset by the application yet.</td> </tr> <tr> <td></td> <td>Cancelled</td> <td>The alarm has been deleted (only relevant for Info-Log, see Info-Log screen)</td> </tr> </tbody> </table>	Column	Description		State	The column shows the status icon of the alarm			Active	Pending alarm		Inactive	Alarm is reset by the application, but not yet acknowledged by the user		Confirmed	The alarm has been acknowledged by the user, but has not been reset by the application yet.		Cancelled	The alarm has been deleted (only relevant for Info-Log, see Info-Log screen)
State	Time	Class	Description																																												
	11/6/13 2:20:45 PM	▲	Drive E-Drive1 not initialized																																												
	11/6/13 2:20:35 PM	▲ ₁	HRC Ready Interlock is not ON. Check HRC temperatures and r																																												
	11/6/13 2:20:35 PM	▲ ₂	EDrive Plate# 1 : Servo is not Enabled.																																												
	11/6/13 2:20:35 PM	▲ ₃	Nozzle not referenced																																												
	11/6/13 2:20:34 PM	▲ ₂	EDrive Plate# 1 : Homing is required																																												
	11/6/13 2:20:34 PM	▲ ₂	EDrive Plate# 1 : is not in Auto Mode. This blocks the E67 Robot.																																												
Column	Description																																														
State	The column shows the status icon of the alarm																																														
	Active	Pending alarm																																													
	Inactive	Alarm is reset by the application, but not yet acknowledged by the user																																													
	Confirmed	The alarm has been acknowledged by the user, but has not been reset by the application yet.																																													
	Cancelled	The alarm has been deleted (only relevant for Info-Log, see Info-Log screen)																																													
<table border="1"> <thead> <tr> <th>State</th> <th>Time</th> <th>Class</th> <th>Description</th> </tr> </thead> <tbody> <tr> <td></td> <td>11/6/13 2:20:45 PM</td> <td>▲</td> <td>Drive E-Drive1 not initialized</td> </tr> <tr> <td></td> <td>11/6/13 2:20:35 PM</td> <td>▲₁</td> <td>HRC Ready Interlock is not ON. Check HRC temperatures and r</td> </tr> <tr> <td></td> <td>11/6/13 2:20:35 PM</td> <td>▲₂</td> <td>EDrive Plate# 1 : Servo is not Enabled.</td> </tr> <tr> <td></td> <td>11/6/13 2:20:35 PM</td> <td>▲₃</td> <td>Nozzle not referenced</td> </tr> <tr> <td></td> <td>11/6/13 2:20:34 PM</td> <td>▲₂</td> <td>EDrive Plate# 1 : Homing is required</td> </tr> <tr> <td></td> <td>11/6/13 2:20:34 PM</td> <td>▲₂</td> <td>EDrive Plate# 1 : is not in Auto Mode. This blocks the E67 Robot.</td> </tr> </tbody> </table>	State	Time	Class	Description		11/6/13 2:20:45 PM	▲	Drive E-Drive1 not initialized		11/6/13 2:20:35 PM	▲ ₁	HRC Ready Interlock is not ON. Check HRC temperatures and r		11/6/13 2:20:35 PM	▲ ₂	EDrive Plate# 1 : Servo is not Enabled.		11/6/13 2:20:35 PM	▲ ₃	Nozzle not referenced		11/6/13 2:20:34 PM	▲ ₂	EDrive Plate# 1 : Homing is required		11/6/13 2:20:34 PM	▲ ₂	EDrive Plate# 1 : is not in Auto Mode. This blocks the E67 Robot.	<table border="1"> <thead> <tr> <th>Column</th> <th colspan="2">Description</th> </tr> </thead> <tbody> <tr> <td>Time</td> <td colspan="2">Date and time when the alarm occurred.</td> </tr> <tr> <td>Class</td> <td colspan="2">Division of alarm classes*: 1 System error 2 Machine error 3 Process error 4 Not used at the moment 5 Information 6 Synchronization point reached</td> </tr> <tr> <td colspan="3">Note*: Alarm classes are used to identify the level of alarm and are useful to sort, filter or group alarms. It is a convention used to determine the severity of an alarm with 1 being the most severe.</td> </tr> <tr> <td>Description</td> <td colspan="2">Alarm text</td> </tr> </tbody> </table>	Column	Description		Time	Date and time when the alarm occurred.		Class	Division of alarm classes*: 1 System error 2 Machine error 3 Process error 4 Not used at the moment 5 Information 6 Synchronization point reached		Note*: Alarm classes are used to identify the level of alarm and are useful to sort, filter or group alarms. It is a convention used to determine the severity of an alarm with 1 being the most severe.			Description	Alarm text				
State	Time	Class	Description																																												
	11/6/13 2:20:45 PM	▲	Drive E-Drive1 not initialized																																												
	11/6/13 2:20:35 PM	▲ ₁	HRC Ready Interlock is not ON. Check HRC temperatures and r																																												
	11/6/13 2:20:35 PM	▲ ₂	EDrive Plate# 1 : Servo is not Enabled.																																												
	11/6/13 2:20:35 PM	▲ ₃	Nozzle not referenced																																												
	11/6/13 2:20:34 PM	▲ ₂	EDrive Plate# 1 : Homing is required																																												
	11/6/13 2:20:34 PM	▲ ₂	EDrive Plate# 1 : is not in Auto Mode. This blocks the E67 Robot.																																												
Column	Description																																														
Time	Date and time when the alarm occurred.																																														
Class	Division of alarm classes*: 1 System error 2 Machine error 3 Process error 4 Not used at the moment 5 Information 6 Synchronization point reached																																														
Note*: Alarm classes are used to identify the level of alarm and are useful to sort, filter or group alarms. It is a convention used to determine the severity of an alarm with 1 being the most severe.																																															
Description	Alarm text																																														
Menu Buttons																																															
Confirm	The user can confirm alarms here. Only those alarms that can be confirmed by the user are acknowledged. If an alarm is selected that the user cannot confirm, an info window notifies of this. Several alarms may be selected one after the other.																																														
Confirm all	Confirmation of all pending alarms. To acknowledge all alarms it is not necessary to select the alarms.																																														
Alarm History	Shows the history of alarms.																																														
Help	This button can call up an alarm help for a selected alarm line.																																														

7.38 Mold Data Screen

Mold specific settings such as movement settings, profile, temperature setpoints and others may be stored (saved) and recalled (loaded). The upper section contains a table that shows the saved mold settings. A mold data record contains the settings for profiles, temperatures, mold height, etc.

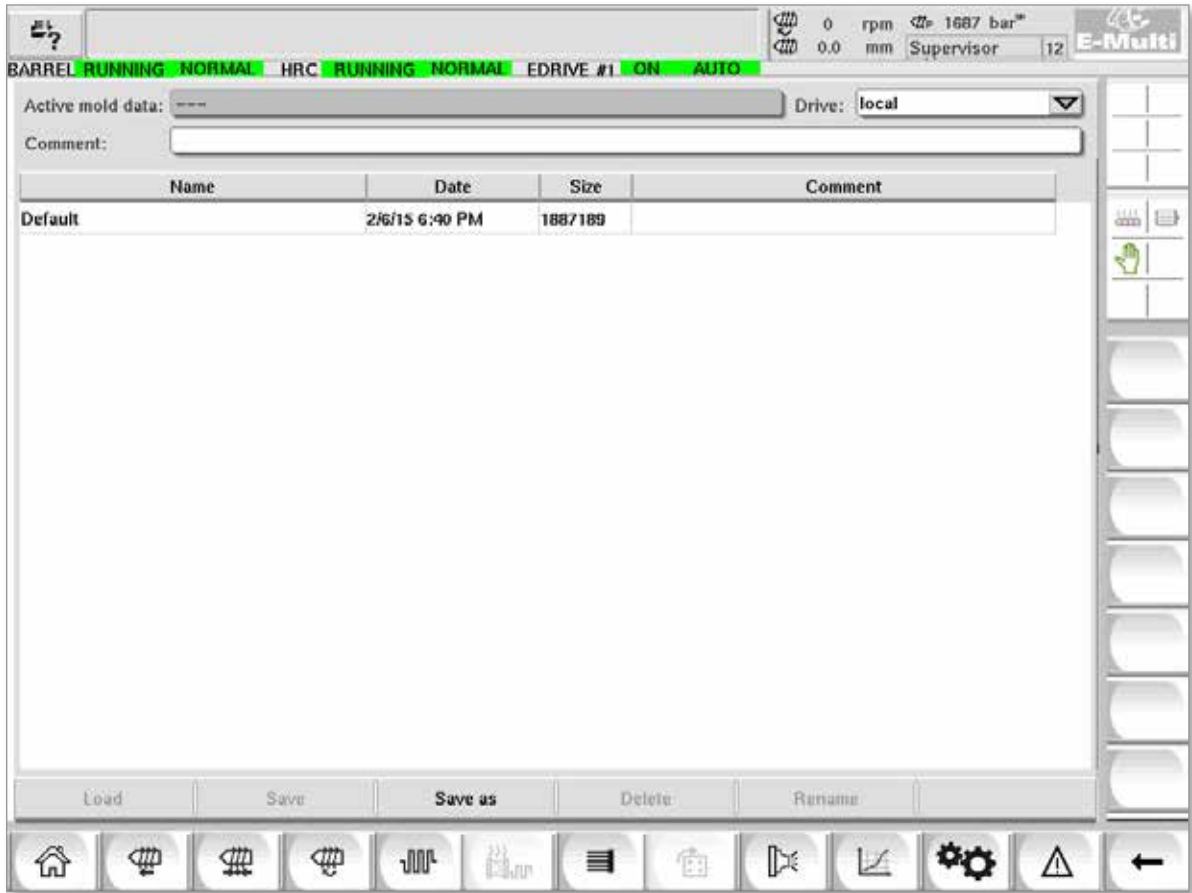



Figure 7-43 Mold data screen

Table 7-57 Mold Data Screen Components		
Screen Components		
	Element	Description
	Active mold data	Currently loaded mold settings.
	Drive	Selection of a drive (local compact flash or USB stick) for saving and loading mold settings.
	Comment	Comments about the current mold settings.

Mold Data Screen - continued

Table 7-57 Mold Data Screen Components		
Screen Components		
	Name	Name of the mold settings.
	Date	Creation date.
	File size	File size.
	Comment	Comments about the mold settings.

7.38.1 Lower Menu Buttons



Figure 7-44 Mold data screen lower menu buttons

Table 7-58 Mold Data Screen Menu Buttons	
Menu Buttons	
Load	Loads the selected mold settings file.
Save	Saves the current mold settings to a file. If the settings file exists, the current settings will overwrite the previously saved settings.
Save as	Saves the current mold settings to a new file.
Delete	Deletes the selected mold settings file.
Rename	Renames the selected mold settings file.



NOTE

Do not load a standard E-Multi mold setting file on a E-Radial system as the profile limits could be outside of normal operating conditions.

In the case where a standard mold setting file was loaded, loading a E-Radial mold setting file will correct the profile.

7.39 Euromap E67 Screen

This screen allows the user to monitor the hard wired I/O that is between the molding machine, E-Multi and the robot. The screen may be accessed by pressing the E67 button on the contextual menu bar from the home screen.

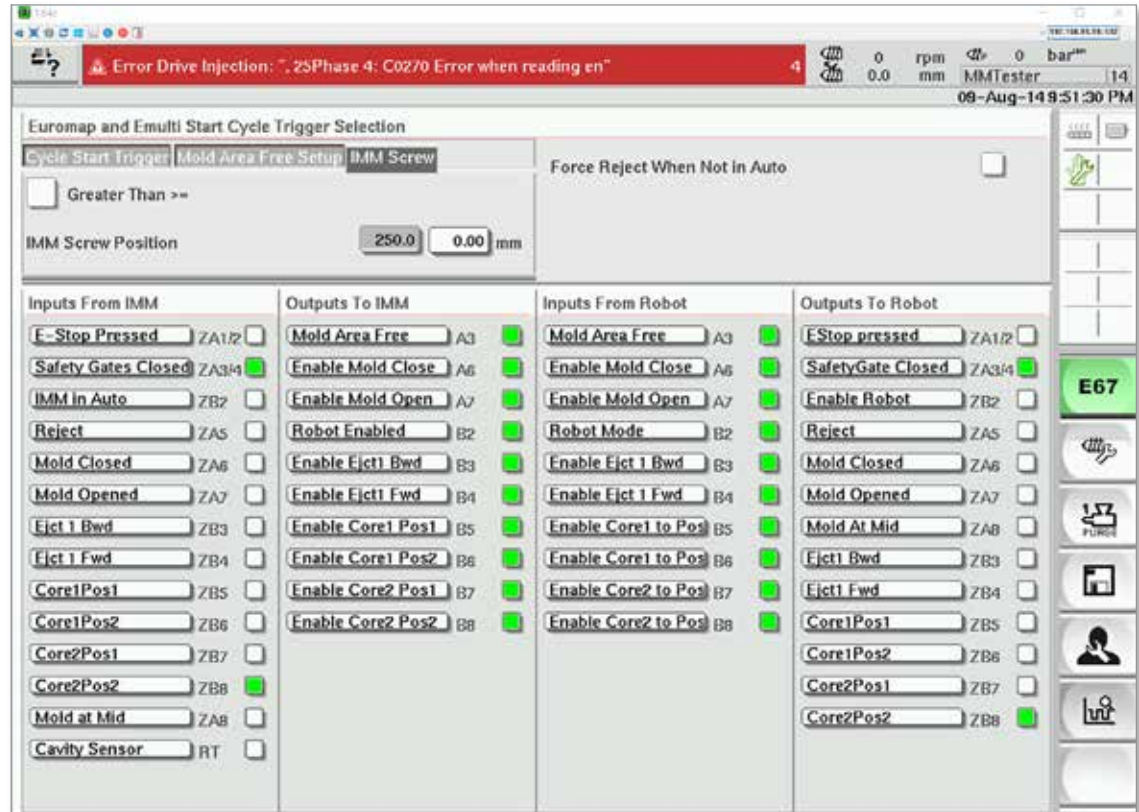

Figure 7-45 Euromap E67 screen

Table 7-59 Fields of the Cycle Start Trigger Tab	
Field	Description
	<p>Start delay time Delay between the trigger signal from the IMM and the start of E-Multi injection cycle.</p> <p>Start delay count: Used to delay E-Multi injection by ignoring the trigger signal for the specified number of cycles. Useful for transfer molding when the IMM cavity is empty for the first shot.</p>

Table 7-60 Fields of the Mold Area Setup Tab	
Field	Description
	<p>Injection & Hold The mold area free signal is blocked when E-Multi injection starts and is released when E-Multi hold is finished.</p>
	<p>Injection & Recovery The mold area free signal is blocked when E-Multi injection starts and is released when E-Multi recovery is finished or the E-Multi cooling time (on the hold page) is finished, whichever is longer.</p>
	<p>Never The mold area free signal is never blocked by the E-Multi. Any auxiliary equipment in the same chain such as a robot can still turn the signal off.</p>
	<p>Carriage Motion Only valid with servo carriage systems using sprue break. The mold area free signal is blocked when the carriage starts to move towards the mold before injection and is released once the carriage returns to the sprue break position.</p>

Table 7-61 Fields of the IMM Screw Tab	
Field	Description
	<p>Greater Than >= Tap the Greater Than >= checkbox to switch the screw direction so injection starts when the IMM screw position rises to the value entered in the IMM Screw Position field.</p>
	<p>IMM Screw Position When using the IMM screw position, injection will start when the IMM screw position falls to the position entered in the IMM Screw Position field.</p>

Table 7-62 Fields of the Force Rejection Panel	
Field	Description
	<p>Force Reject When Not in Auto When enabled, the E-Multi controller will turn on the reject signal to the handling system as long as the E-Multi controller is not in automatic mode. This is to ensure that if the E-Multi system has a fault or is not running in automatic, parts will be rejected.</p>

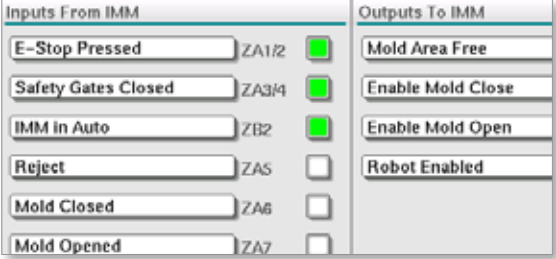
Table 7-63 Fields of the Input and Output Signals Panel	
Field	Description
	<p>Input and Output Signals</p> <p>The lower part of the screen provides an overview of E67 signals. When a signal is ON, the indicator turns green.</p> <p>Indicators may be renamed to match IMM naming conventions or I/O names.</p> <p>The reject signal to the robot will be turned on in the following cases:</p> <ol style="list-style-type: none"> 1. If there is a reject signal from the IMM 2. If the option for “Reject Tracking” is selected in Factory settings and if there is an E-Multi alarm 3. If SPC is being used and there is a bad part detected

7.40 Legacy E67 Screen



NOTE

This screen is shown only on legacy controllers (2013 and earlier).

The screenshot displays the Legacy E67 HMI interface. At the top, a red status bar indicates "Drive Injection not referenced" with a value of 10. The main header shows "HRC STOPPED NORMAL" and "E-Multi". Below this, the "Euromap and Emulti Start Cycle Trigger Selection" section is active, showing "Mold Area Free Setup" as the selected trigger. Parameters include "Start delay time" (0.0 s) and "Start delay count" (0). The "Force Reject When Not in Auto" checkbox is checked.

Inputs From IMM	Outputs To IMM	Inputs From Robot	Outputs To Robot
E-Stop Pressed ZA1/2 <input type="checkbox"/>	Mold Area Free ZA3 <input checked="" type="checkbox"/>	Mold Area Free ZA3 <input type="checkbox"/>	I Stop pressed A1/2 <input type="checkbox"/>
Safety Gates Closed ZA3/4 <input type="checkbox"/>	Enable Mold Close ZA6 <input checked="" type="checkbox"/>	Enable Mold Close ZA6 <input type="checkbox"/>	SafetyGate Closed A3/4 <input type="checkbox"/>
IMM in Auto ZB2 <input checked="" type="checkbox"/>	Enable Mold Open ZA7 <input checked="" type="checkbox"/>	Enable Mold Open ZA7 <input type="checkbox"/>	Enable Robot B2 <input type="checkbox"/>
Reject ZA5 <input type="checkbox"/>	Robot Enabled ZB2 <input type="checkbox"/>	Robot Mode ZB2 <input type="checkbox"/>	Reject A5 <input checked="" type="checkbox"/>
Mold Closed ZA6 <input type="checkbox"/>	Enable Eject1 Bwd ZB3 <input checked="" type="checkbox"/>	Enable Eject 1 Bwd ZB3 <input type="checkbox"/>	Mold Closed A6 <input type="checkbox"/>
Mold Opened ZA7 <input checked="" type="checkbox"/>	Enable Eject1 Fwd ZB4 <input checked="" type="checkbox"/>	Enable Eject 1 Fwd ZB4 <input type="checkbox"/>	Mold Opened A7 <input type="checkbox"/>
Eject 1 Bwd ZB3 <input type="checkbox"/>	Enable Core1 Pos1 ZB5 <input checked="" type="checkbox"/>	Enable Core1 to Pos ZB5 <input type="checkbox"/>	Mold At Mid A8 <input type="checkbox"/>
Eject 1 Fwd ZB4 <input checked="" type="checkbox"/>	Enable Core1 Pos2 ZB6 <input checked="" type="checkbox"/>	Enable Core1 to Pos ZB6 <input type="checkbox"/>	Eject1 Bwd B3 <input type="checkbox"/>
Core1Pos1 ZB5 <input checked="" type="checkbox"/>	Enable Core2 Pos1 ZB7 <input type="checkbox"/>	Enable Core2 to Pos ZB7 <input type="checkbox"/>	Eject1 Fwd B4 <input type="checkbox"/>
Core1Pos2 ZB6 <input checked="" type="checkbox"/>	Enable Core2 Pos2 ZB8 <input type="checkbox"/>	Enable Core2 to Pos ZB8 <input type="checkbox"/>	Core1Pos1 B5 <input checked="" type="checkbox"/>
Core2Pos1 ZB7 <input type="checkbox"/>			Core1Pos2 B6 <input checked="" type="checkbox"/>
Core2Pos2 ZB8 <input type="checkbox"/>			Core2Pos1 B7 <input type="checkbox"/>
Mold at Mid ZA8 <input type="checkbox"/>			Core2Pos2 B8 <input type="checkbox"/>
Remote Trigger RT <input type="checkbox"/>			

The bottom of the screen features a navigation bar with icons for Home, Back, Forward, Stop, Run, and other functions. A vertical toolbar on the right side includes a "E67" button and other control icons.

Section 8 - Preventive Maintenance

The preventive maintenance program enables supervisors and technicians to create maintenance tasks that are to be done after a set number of cycles.



NOTE

Time-based functionality is displayed in the preventive maintenance software but is not implemented.

8.1 Settings Tab (Configuring Tasks)

Use the Settings tab to create and edit maintenance tasks. Only supervisors and technicians can create and edit maintenance tasks.

The screenshot shows the 'Preventive Maintenance' settings window. It has three tabs: 'Active Tasks', 'Settings', and 'Diag'. The 'Settings' tab is selected. Below the tabs is a section 'Select Preventive Maintenance Item' with a 'Task' dropdown menu set to 'PM 1 (Not Enabled) :oil change', a 'Name' text box containing 'oil change', and an 'Enabled' checkbox. The next section is 'Preventive Maintenance Task Triggers', which includes radio buttons for 'Use Time' (unselected), 'Hours' (selected), and 'Days' (unselected). It also has input fields for 'Warning Hours' (0), 'Alarm Hours' (0), 'Use Cycles' (checked), and 'Cycles' (1). Below this is 'Select Counter Trigger' with a dropdown menu set to 'MKValveGate1.do_ValveGate2' and a refresh icon. The 'Messages to be displayed' section has two text boxes: the first contains '10w40' and the second contains 'Check filter'. At the bottom right, there is a link 'Import/Export Task Settings' and two buttons: 'Export' and 'Import'.

8.1.1 Tasks

There are two types of tasks: preventive maintenance (PM) and Milacron. Supervisors will only see the PM type tasks in the dropdown list. MoldMasters technicians will see both PM and Milacron type tasks in the dropdown list.

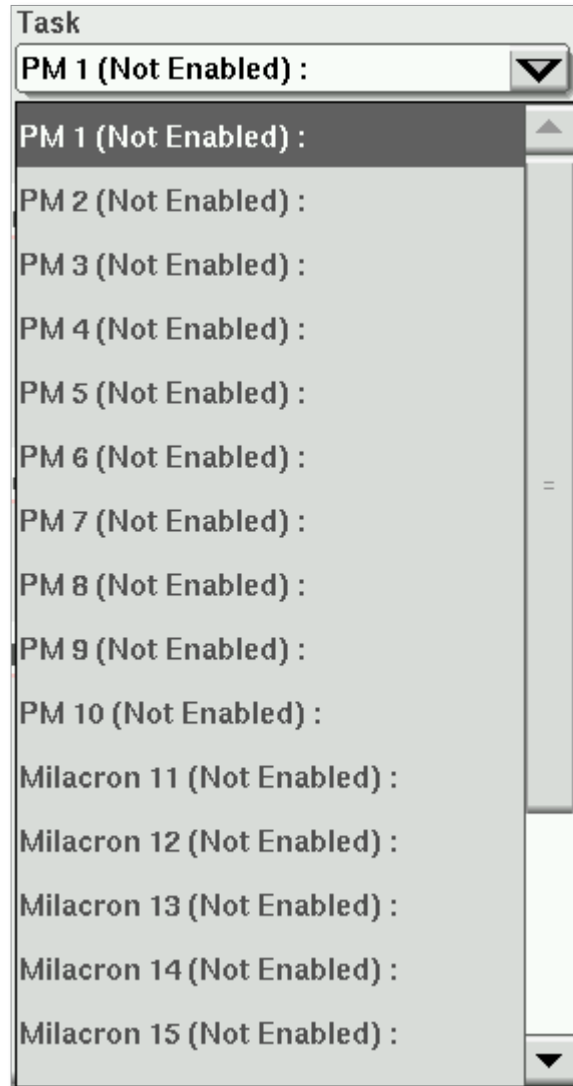

8.1.1.1 PM Task Type

There are 10 PM tasks that can be configured by a supervisor or a MoldMasters technician.

8.1.1.2 Milacron Task Type

When a user logs in with a Milacron technician level authority or higher, an additional 10 tasks become selectable in the dropdown list.

8.1.2 Task Accessibility

At the supervisor level, 10 PM tasks are available. At the technician level, 10 additional tasks are available.

8.1.3 Task Names

Task names can be up to 50 characters. Tasks should be given descriptive names.



Figure 8-3 Naming a task

8.1.3.4 Active Task View

Using active task view, you can view tasks as well as display messages related to the task.



8.1.4 Disabled Tasks

If a task is disabled, the Enabled option button next to the task name will be shown as not selected.

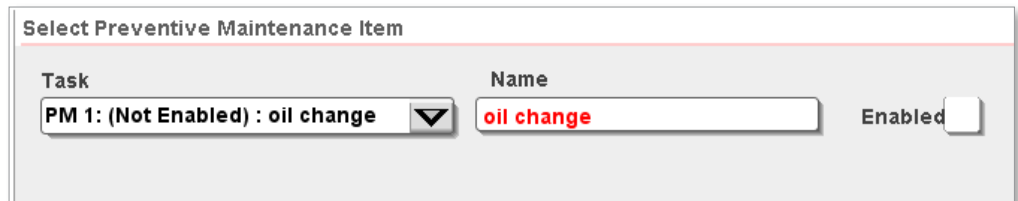

Disabled tasks are not shown in the Active Tasks tab.

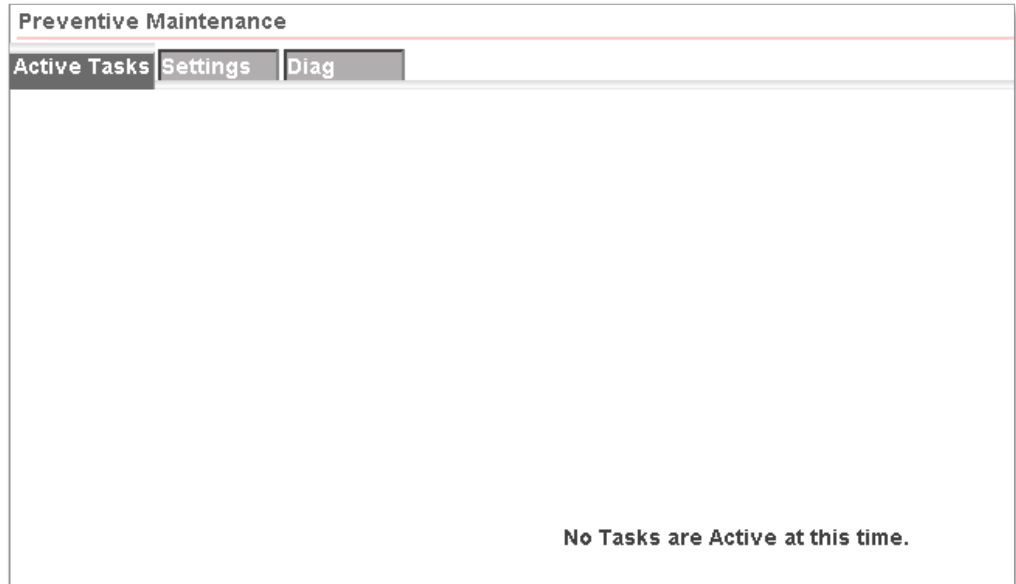

8.1.5 Enabled Supervisor Tasks

If a task is enabled, the Enabled checkbox next to the task name will be shown as selected.

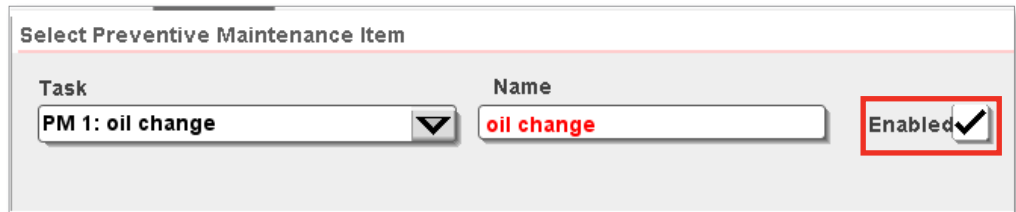

Enabled tasks are shown in the Active Tasks tab.



8.1.6 Cycle Count Triggers

Warning messages and alarm messages can be displayed along with tasks. The Euromap 67 mold-close enable can be prevented if an alarm is reached before a maintenance task is performed and acknowledged in the Active Task tab.

8.1.6.1 Set a cycle count trigger

1. Use the Preventive Maintenance Task Triggers panel to set up a cycle count trigger for a task.

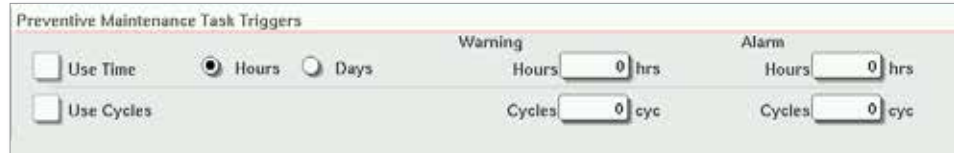

Preventive Maintenance Task Triggers

Use Time Hours Days Warning Hours hrs Alarm Hours hrs

Use Cycles Cycles cyc Cycles cyc

2. Tap the Use Cycles checkbox, and enter a number of cycles in the Warning and/or Alarm boxes.



Preventive Maintenance Task Triggers

Use Time Hours Days Warning Hours hrs Alarm Hours hrs

Use Cycles Cycles cyc Cycles cyc

8.1.6.2 Reaching a warning trigger

When the cycle count reaches the warning level, a red warning message is displayed in the top bar of the screen to inform you that the task is to be performed soon. The machine will still operate normally but the warning message will stay in the alarm list until the task is done and the task acknowledge button is pressed.

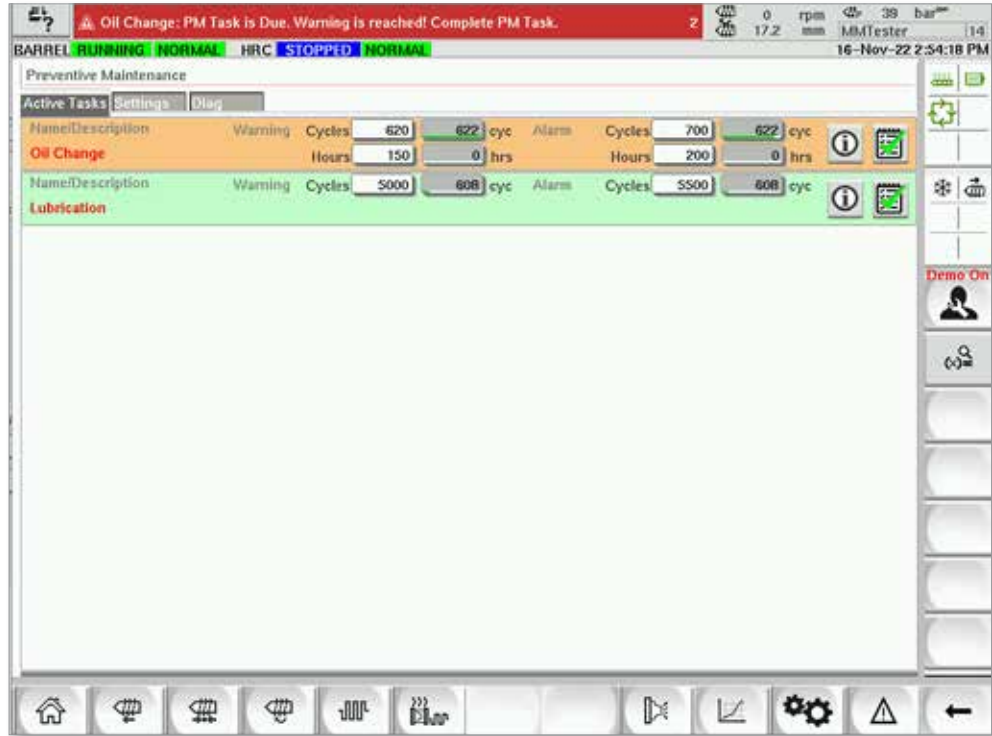

8.1.7 Trigger Selection for Cycle Counting

You can set a task to count cycles from a unique trigger by using the Counter Trigger dropdown list.

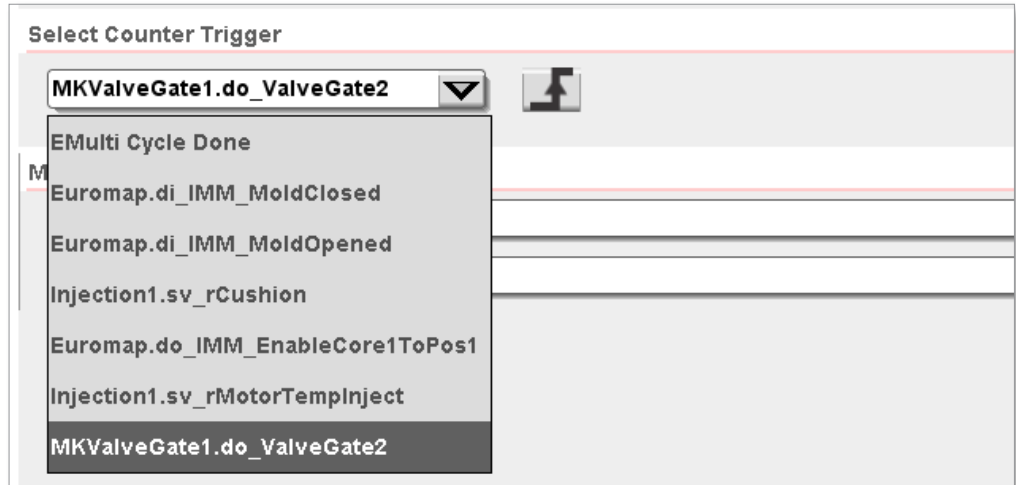

8.1.7.1 Add a trigger to the Counter Trigger dropdown list

You can add a trigger to the Counter Trigger dropdown list using the Variable Monitor screen. The trigger must be one of these data types:

- Boolean
- Integer
- Double integer
- Real or floating point

You must add triggers to the PMTriggers group. If this group does not exist, you can create using the Variable Monitor screen.

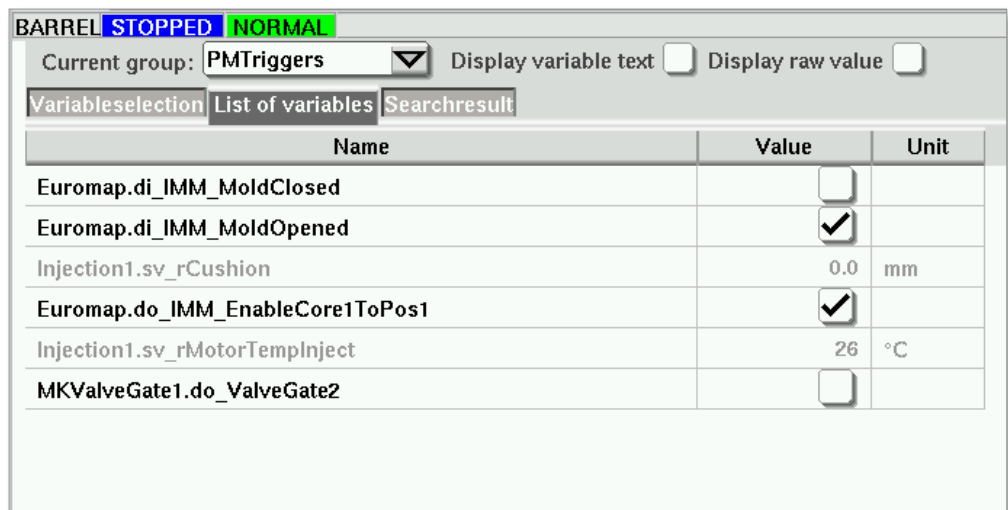

8.1.7.2 Leading/Falling Edge Triggers

Count triggers increment the task counter when the trigger value rises or falls based on the Leading/Falling edge toggle.



Figure 8-3 Rising edge trigger



Figure 8-4 Falling edge trigger

8.1.7.5 Trigger Threshold

If the trigger data type is Boolean, a threshold is not displayed. The Boolean data type is either true or false, so there is no threshold.

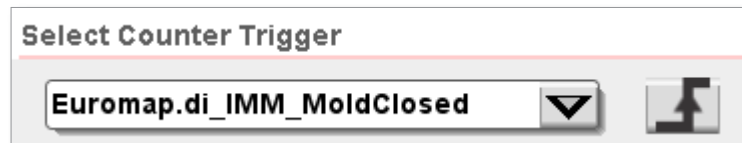

When you choose the integer, double integer, or floating point data type, you must enter a threshold value. When the leading or falling edge of the variable crosses the threshold, the counter is incremented.

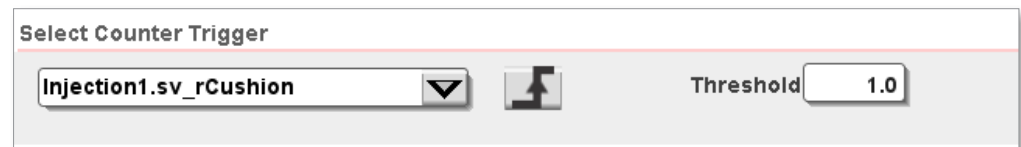

8.1.8 Messages

8.1.8.1 Enter a message to be displayed

There are two text lines you can use to provide more information about a task. You can use these lines of text to inform maintenance personnel about tools and equipment that are required to perform the task.



8.1.8.2 View messages

You can view messages in the active task tab by tapping the info button of a task.

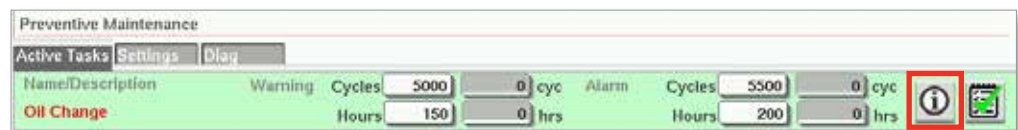

A message dialog box will appear when you tap the information button.

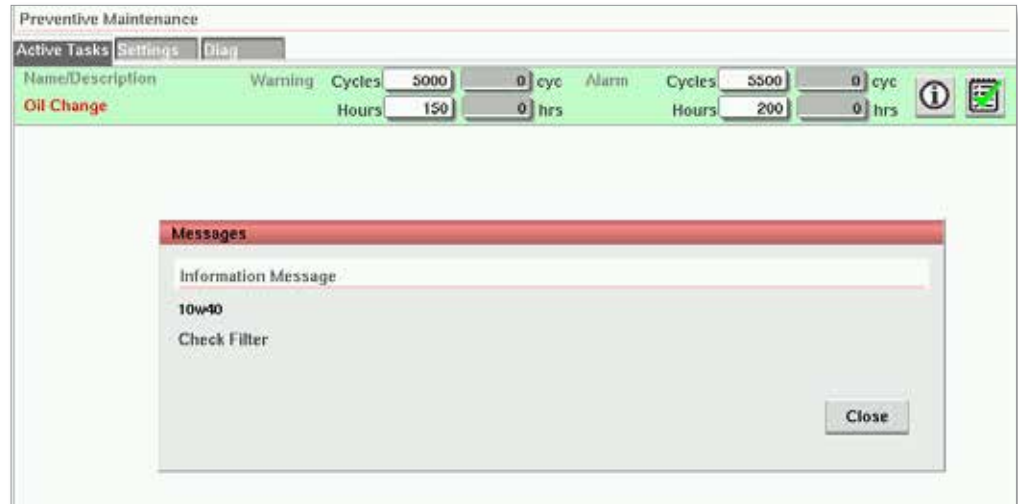

8.1.9 Milacron User Level Tasks

When you are logged in as the Milacron Technician level or higher another 10 tasks are available



8.1.9.1 Alarm Function

A Milacron technician can control whether the task alarm level prevents the Mold Close Enable from being allowed by selecting or leaving unselected the Disable Mold Close on Alarm checkbox.



Milacron User Level tasks record events in the event log. If you only want to record the alarm and have no warning, set both the alarm count and the warning count to the same value.

8.1.10 View Milacron Active Tasks

All Milacron tasks are added to the Diag tab of the Preventive Maintenance screen.



8.1.11 Color Codes of Active Tasks



NOTE

Warnings do not prevent a machine from functioning. They only inform that maintenance is due.

8.1.11.1 Normal PM Not Due

When a task is not at the warning count level, the task is colored green and no messages are displayed.



8.1.11.2 Task is Due

When the task counter is greater than the warning threshold but less than the alarm threshold, a warning message is displayed, the task is highlighted orange, and the Acknowledge button is displayed.



8.1.11.3 Task is Overdue

When a task counter is greater than the alarm threshold, an alarm message is displayed, the task name is colored red, and the Acknowledge button is displayed.

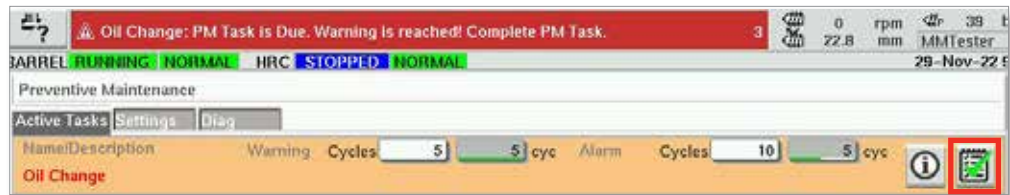

If the task is not a Milacron task set for logging only, this alarm prevents the machine from functioning. The Euromap 67 Enable Mold Close signal is blocked, and the molding machine will not be able to close the mold. Maintenance must be performed and acknowledged to allow the machine to operate.

8.1.12 Acknowledge a Task Has Been Performed

When the task counters are greater than the warning level, the Acknowledge button is displayed on the task.



1. Tap the Acknowledge button to resume normal operation.

8.2 Reporting and Log View

8.2.1 View the preventive maintenance history

1. Tap the Log screen button on the main screen to view the preventive maintenance history

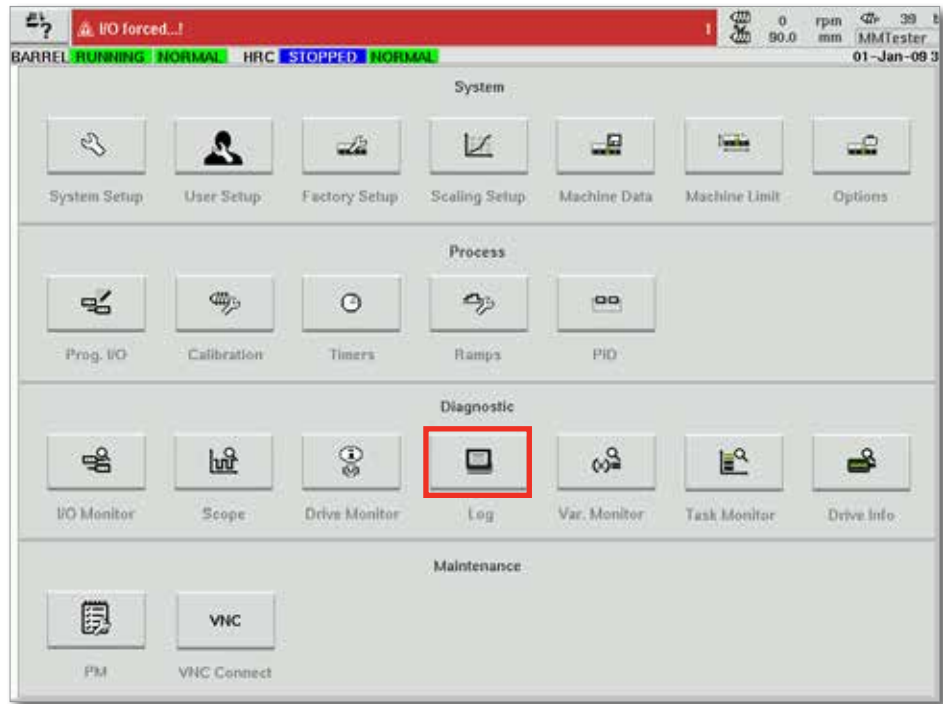

2. Tap the Setup button.

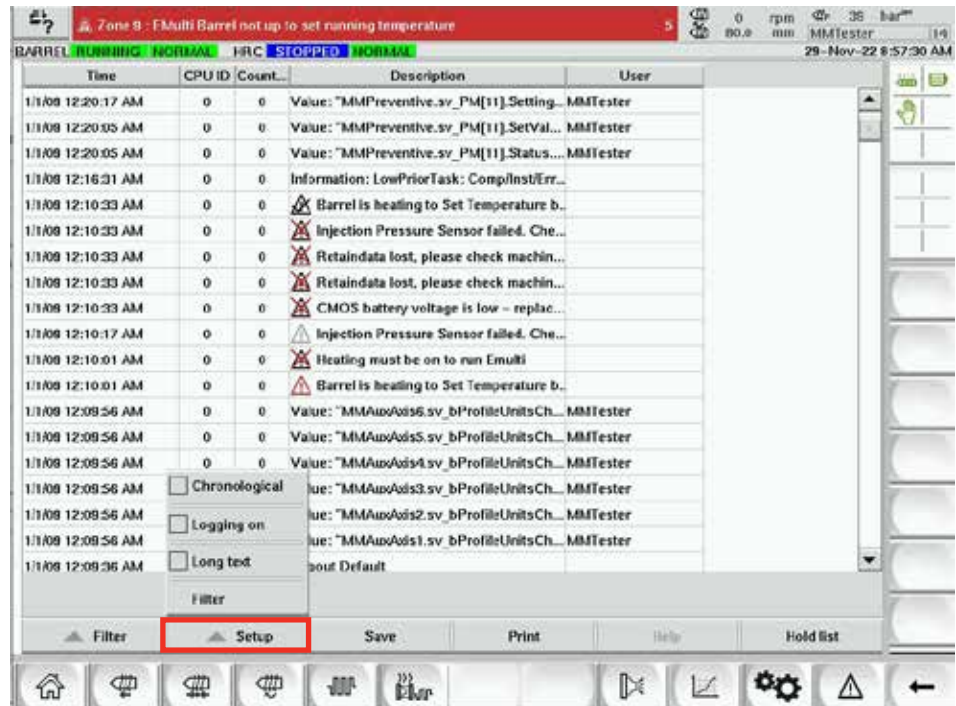

- Tap the Alarm 7 checkbox. Alarm level 7 is used for all preventive maintenance.

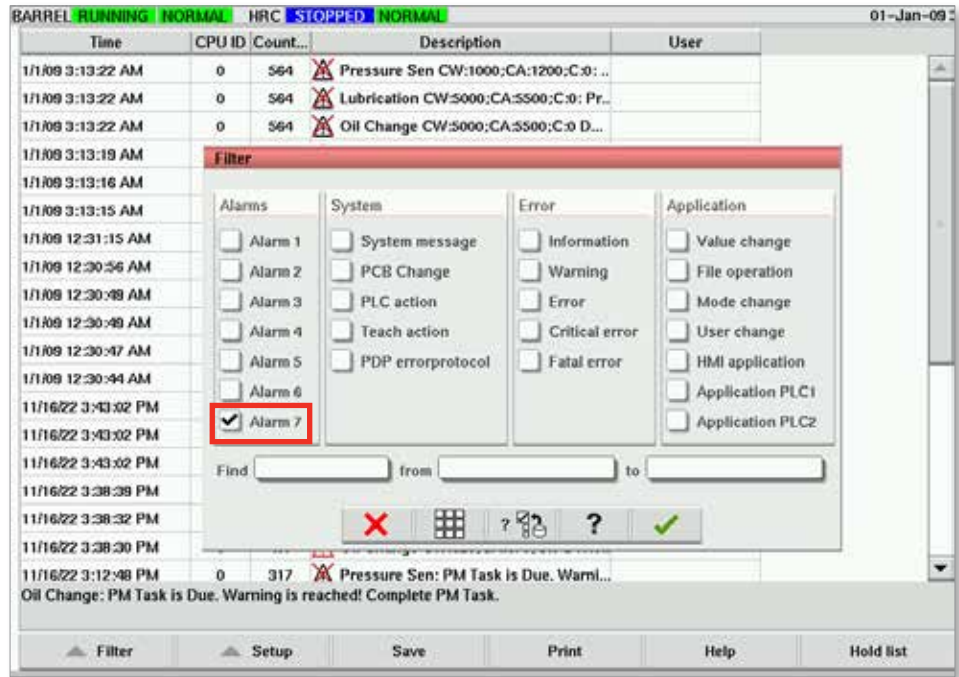

- Use the From and To input boxes to enter time search criteria.

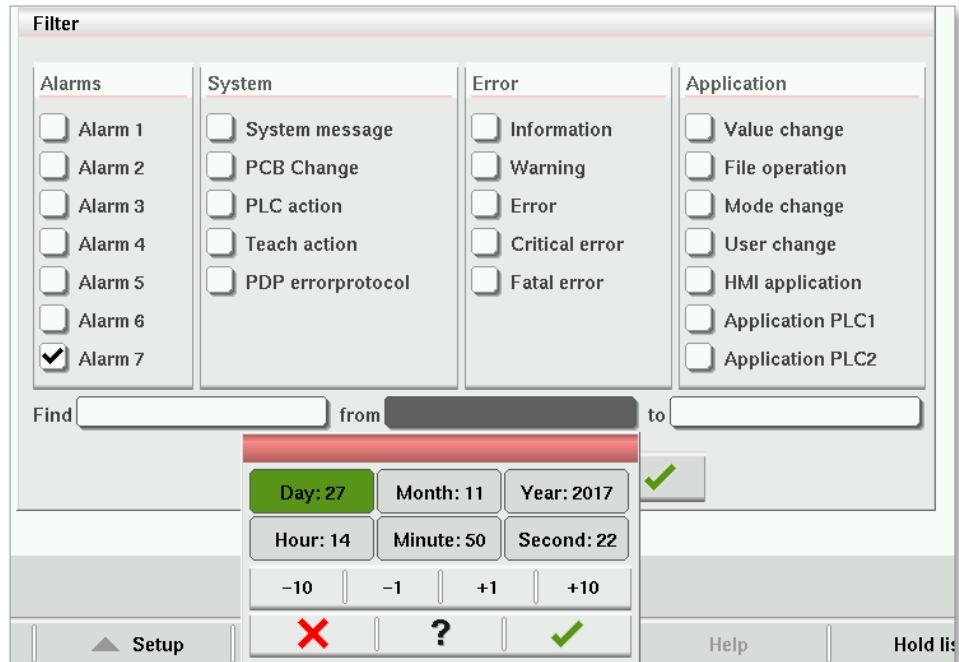

5. Enter other search criteria, if necessary.

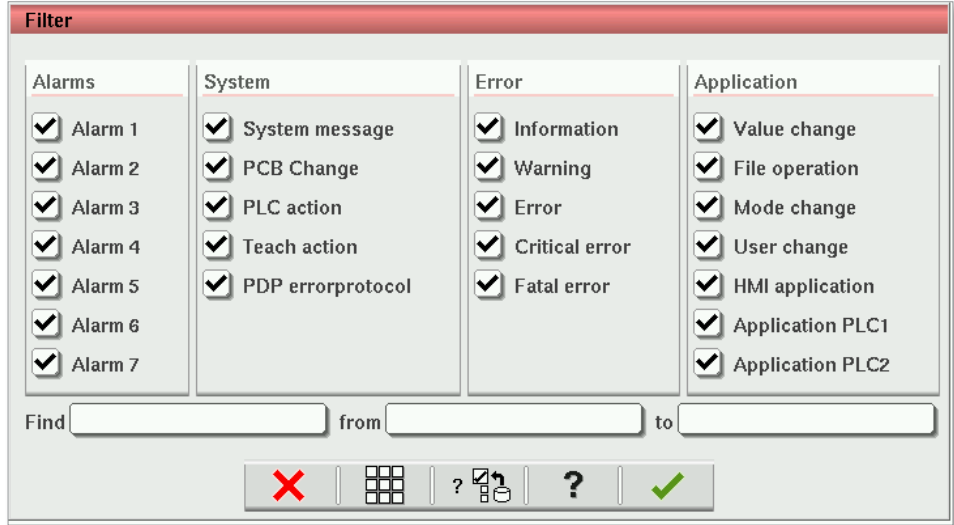

6. Tap the Accept button.

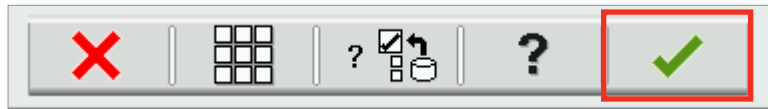

8.2.1.1 Clear filter selections

1. Tap the clear settings button.

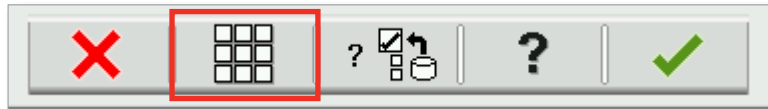

Section 9 - Maintenance



WARNING

Ensure that you have fully read “Section 3 - Safety” before doing maintenance procedures on the controller.

9.1 Clean the HMI Screen

The HMI screen should be cleaned, whenever required, with a moist, soft, clean cloth and glass cleaner. The glass cleaner should be sprayed onto the cloth and not directly onto the HMI surface.

The screen can be temporarily disabled to touch input by pushing the [Lock] button on the bottom of the “7.22 System Settings Screen” on page 7-62. This will disable the touchscreen input for 10 seconds.

The surface coating of the touch screen is resistant to the following solvents:

- Heptane
- Alcohol
- Toluene
- Acetone
- Methyl ethyl ketone
- Unleaded gasoline
- Hydrochloric acid
- Turpentine
- Gear oil

The surface is *not* resistant to 40% sodium hydroxide which will cause white discoloration of the screen.

9.2 Preventive Maintenance

Table 9-1 Preventive Maintenance Schedule	
Preventive Maintenance	Frequency
Controller fan filters	Check monthly, replace if necessary

9.3 Put the Servo Carriage in the Maintenance Position

1. Tap the servo carriage button on the right menu bar of the home page.

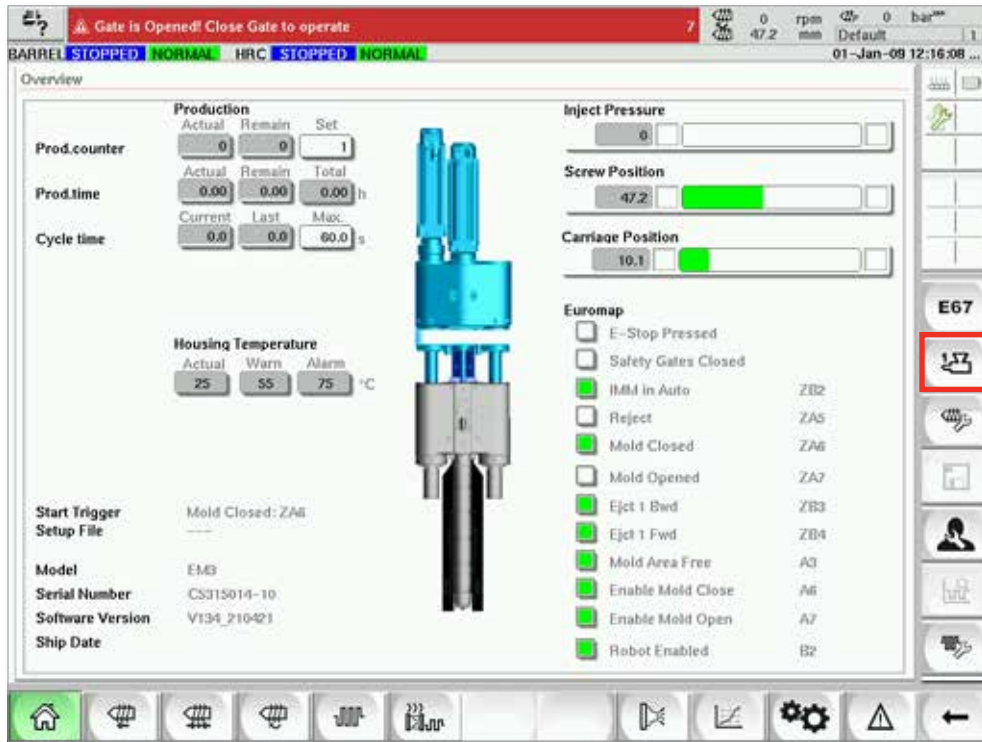

Figure 9-1 Home page

2. Tap the Service Position button.



Figure 9-2 Servo carriage page

9.4 Verify Injection Pressure Oil Circuit (Preload Pressure)

The E-Multi controller uses a pressure transducer in the injection pressure oil circuit to monitor injection pressure during the injection cycle. The pressure in the circuit should be within specifications. See Table 9-4 of the E-Multi User Manual for the respective size for specifications.

9.4.1 Check the Preload Oil Pressure



WARNING

Do not open the high pressure port plugs. High pressure port plugs have plastic plug caps installed to prevent accidental opening.

1. Always check with E-Multi preload pressure at operating temperature and idle pressure.
2. On the controller, tap the Operation Mode Select button and choose Set Up Mode. Check the F1 LED. If it is not blinking, press the F1 key to put the controller into setup mode.
3. Check the screw position. If the position is greater than half the stroke, move the screw to the half stroke position, and then move the screw back approximately 25 mm (1.0") further. This will decompress the screw and make sure the pressure value is showing idle pressure.
4. Check the pressure reading on the controller.
If the pressure is below the lower limit, the high pressure circuit will need to be re-charged using the E-Multi Oil Fill Kit.
5. Navigate to the screw settings page. Verify that the actual voltage is within the limits. Refer to the Engineering Specification Document for the respective size for specifications.

9.5 Nozzle Protrusion Adjustment - Automatic Adjustment

9.5.1 Carriage Home Position Calibration



WARNING

This procedure requires visual inspection of the machine while it is moving. Wear eye protection.



IMPORTANT

For proper calibration, ensure the nozzle protrusion is set correctly.

The first time the E-Multi is installed, and any time it is transferred to a new machine with a different mold, the carriage home position and contact force must be set.

9.5.2 Manual Calibration

1. Put the E-Multi into setup mode.
2. Navigate to the Reference Settings page.
3. Move the carriage forward until the nozzle is just touching the manifold inlet.
4. Choose Set on the screen.

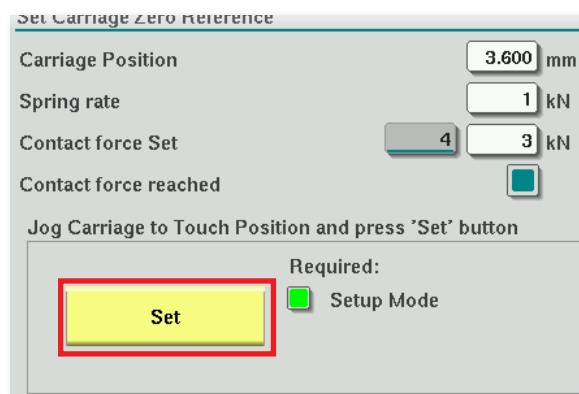

5. Press the [F4] button on the controller to increase nozzle contact force. Continue pressing until the motor stops moving and the Contact force Set display field stops increasing. The value in the display field is the maximum contact force that can be generated with the current setup.
6. Tap the Contact force set entry field (the field to the right) to set the desired nozzle contact force.
A typical setting is 25-50% of the maximum observed in the previous step.
7. Put the controller in Manual mode.
8. Use the [F3] button to move the nozzle away from the mold until there is a gap.
9. Press and hold the [F4] button to move the nozzle towards the mold until it stops.
Verify that the contact force is equal to or slightly greater than the set point chosen in step 6.

9.5.3 Automatic Calibration

1. Put the controller in setup mode.
2. Make sure barrel heaters are at operating temperature.
3. Tap the **[Start]** reference button.

If the nozzle is adjusted correctly, the routine will complete and the nozzle tip position graphic will show the nozzle tip in the green region.

If the nozzle is not adjusted correctly, the carriage will move to a preset position and tell the operator to adjust the nozzle using the manual adjuster screw. Once the adjustment is made, press the **[Start]** button again to run the calibration routine again.

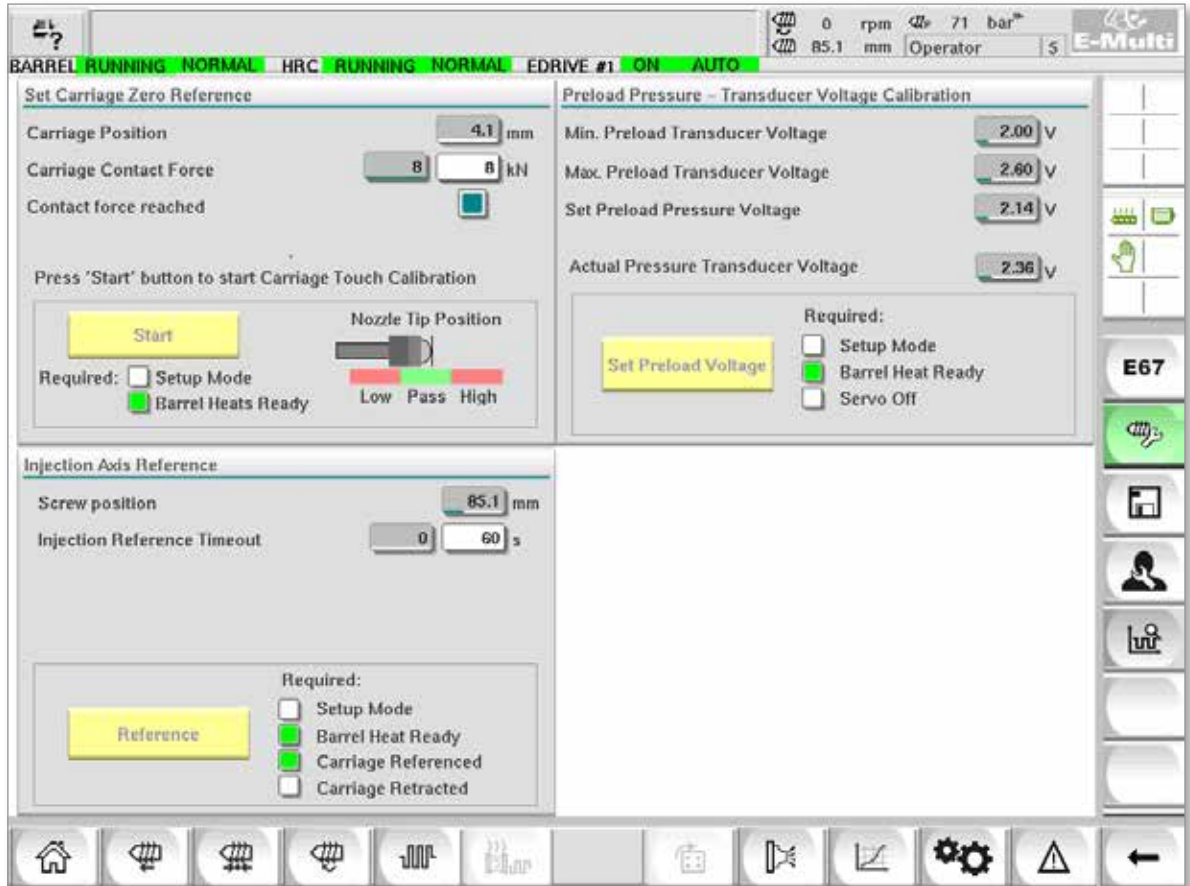

Figure 9-3 Nozzle protrusion adjustment - Radial and Servo carriage models

9.6 Injection Axis Referencing



CAUTION

The injection referencing routine verifies the injection stroke by moving the screw fully back and then fully forward.

Referencing will fail if the screw cannot achieve the full stroke.

1. Controller must be in setup mode with heats on and up to operating temperature, carriage referenced and carriage retracted from the mold.
2. Navigate to the screw settings page.
3. In the lower left-hand area, tap the Reference button.
4. Confirm the dialog box that appears.



NOTE

Once the dialog is confirmed, the injection axis will move automatically.

5. Wait for the screw to move fully back and then fully forward. Referencing is complete when the screw position is just below 0.

9.7 Service and Repair The Controller



WARNING

Always isolate your controller at source before you open the unit to inspect it or replace fuses.

9.7.1 Replacement Parts

Mold-Masters does not expect that you will need to repair any controller parts at board level other than fuses. In the unlikely event of any board failure then we provide an excellent repair and exchange facility for all our customers.

9.7.2 Cleaning and Inspection



CAUTION

External cables should be checked to see that there has been no damage to the flexible conduit, plugs or sockets. If the flexible conduit has been damaged or if there are any exposed conductors, the loom must be replaced.

Every environment suffers some degree of contamination, necessitating the need to inspect the fan filters at regular intervals (monthly is recommended). If filters are clogged, they need to be replaced. Replacement filters can be obtained from *Mold-Masters*. Please quote the model type and year of manufacture.

Any excess dust that has entered into the cabinet may be removed with a light brush and vacuum cleaner.

If the equipment is subject to vibration, we recommend you use an insulated screwdriver to check that no terminals have become loose.

9.8 Update Software

It is not necessary to send your control system back to the *Mold-Masters* factory for upgrades. Instead they will, on request, be sent to you in the form of one compact flash card that can be read by your controller. The following instructions will guide you through the upgrade procedure.

Mold-Masters recommends that you always wait until your controller is free before implementing any upgrade. This ensures that, in the event of a mishap such as an error, or a power interruption at a crucial point, that normal production will not be adversely affected.

9.8.1 Save Mold Data



CAUTION

Recipes and machine data are stored on the compact flash card. It is important to save the machine data and mold data prior to upgrading software.

1. Insert a USB key into the USB port located on the side of the controller.



NOTE

Mold data files must be active (loaded) before they can be saved. Only the active file will be saved. Each additional date file to be saved must be activated (loaded) before saving.

2. Load the mold data file to be saved. If the mold data file to be saved is already loaded skip to step 4.
3. Select Local from the Drive: drop down menu. Select the desired file, then tap the Load button.
A message box will display Loading Complete once the file is active. The active mold data filename appears at the top of the screen.

Save Mold Data - continued

4. Navigate to the mold data screen.

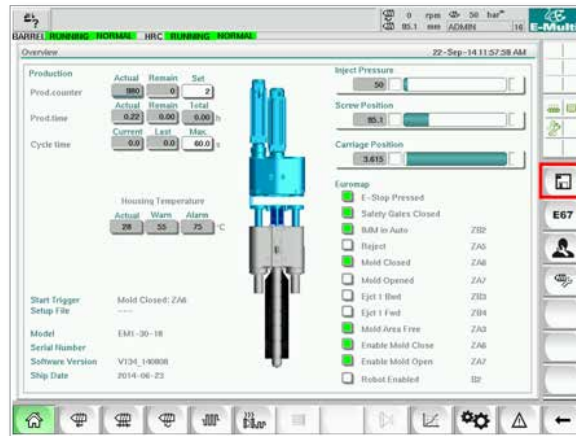

5. From the Drive: drop down menu, select USB0.
6. Tap the Save button to save the active mold data file (as displayed along the top of the screen) to the USB key.
7. Repeat this procedure for each mold data file to be saved.

9.8.2 Save Machine Data

1. Insert a USB key into the USB port located on the side of the controller.



2. Navigate to the machine data screen.



Save Machine Data - continued

3. From the Drive: drop down menu, select USB0.
4. Tap the Save Machine Data button.
5. Tap the Back up Machine Data button.
6. Remove the USB drive. Using another computer, verify that the mold and machine data files have been saved to the USB drive.

9.8.3 Install New Software

1. Power down the controller following the instructions in “6.3 Switch On” on page 6-2.
2. Remove the existing compact flash card.
The compact flash card is located on top of the PLC. There is a black tab on top of the PLC next to the card slot. Press the back of the tab down to eject the compact flash card from the holder.



3. Install the new compact flash card with the connector-side down.
The card and slot are keyed and the card should slide into the slot easily. Do not force the card if it does not slide easily. The card is properly installed when the top of the card is at the same level as the top of the PLC.
4. Insert the USB key with the machine and mold data backup files.



Install New Software - continued

5. Power on the controller following the instruction in “6.3 Switch On” on page 6-2.
6. Log in as Supervisor.
7. Navigate to the Machine Data screen. Select USB0 from the drop down menu, then tap the Load Machine Data button.



8. Navigate to the Mold Data screen. Select USB0 from the drop down menu, then tap the Load Mold Data button.

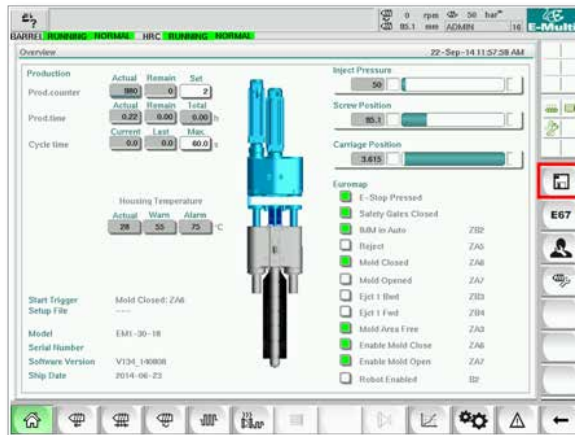

9. Navigate to the Heat set up page. Follow the button sequence below to select the Auto Detect button.

Install New Software - continued

a) Tap the Barrel Temperature Settings button.

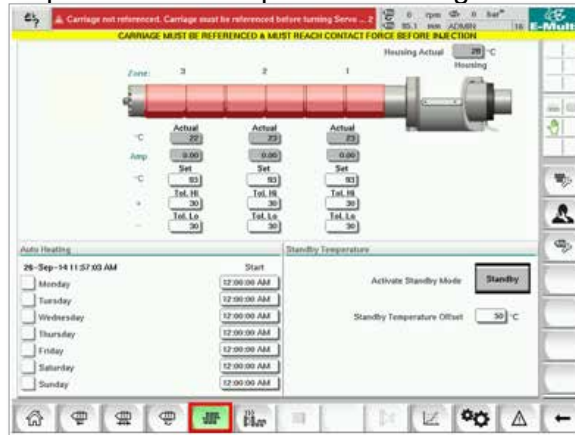

b) Tap the Hot Runner Control Setup button.

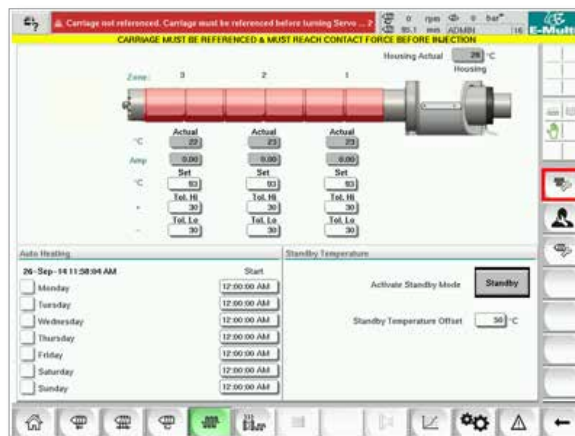

c) Tap the Auto Detect button.



10. When the Auto Detect sequence is complete, power down the controller following the instructions in “6.4 Switch Off (Shutdown)” on page 6-2.

11. Power on the controller, following the instruction in “6.3 Switch On” on page 6-2 to complete the software upgrade.



NOTE

E-Multi controllers support only FAT or FAT32 formatted USB drives. USB drives formatted as NTFS, HFS(+), or EXT will not work.

Section 10 - Troubleshooting



WARNING

Ensure that you have fully read “Section 3 - Safety” before troubleshooting any issues with the controller.

10.1 Thermocouple Electrical Check

The controller system has functionality to monitor thermocouple performance.

1. A working thermocouple will show a realistic temperature based on the environment it is in. Defective thermocouples will read -100°C on the controller.
2. If a thermocouple shows as defective, test the thermocouple at the support beam or hot runner connector. Thermocouples should show output similar to those in the same area. If the output is significantly different, replace the thermocouple.
3. If the new thermocouple shows -100°C there is probably a wiring problem. Check the wiring and connections.

10.2 Heater Continuity Check

This procedure requires access to the heater connector. Power down the machine before disconnecting heater cable.

1. Testing of the heaters is done with a multimeter set to measure resistance.
2. The heaters are wired to the connector in pairs according to the wiring schematic.
3. Checking the resistance across the pins should show around 48 ohms for a 1000 W heater and 96 ohms for a 500 W heater.
4. A reading of 0 ohms indicates a shorted heater and a reading of infinity indicates an open heater.

10.3 Transducer Output Check

Transducer function is checked automatically every cycle. If the transducer is defective, an alarm will be shown on the controller.

10.4 Vibrator Valve Check

1. The vibrator runs on every cycle when the feed screw is turning. If the vibrator is not moving, check the air pressure to the vibrator by closing the air needle valve and disconnecting the air line from the supply side of the valve.
2. Open the needle valve slowly and check for air pressure on the supply line. If there is no pressure, check the pneumatic connection to the machine. If there is pressure, close the valve, reconnect the air line to the

Vibrator Valve Check - continued

valve and open the valve.

3. Next, check the mechanical function by disconnecting the air supply tube from the solenoid valve on the support beam and applying compressed air to the tube. If the vibrator is working properly, it should start to vibrate when compressed air is applied.
4. If the vibrator is working, reconnect the air line to the valve and disconnect the valve cable. Apply 24 VDC to pin 1 and 0 VDC to pin 2. The valve should open and the vibrator should start to vibrate. If the valve does not move, replace the valve with a known good one.

10.5 Servo Motor Temperature Check

The motor warning and alarm temperatures are factory settings that can only be changed by a *Mold-Masters* technician. The default values are:

Warning temperature: 75°C

Alarm temperature: 80°C

The E-Multi controller automatically disables the motors when the alarm temperature is reached. The motor temperature can be monitored in real time on the “Drive Monitor Screen” on page 7-75.

Motor temperature alarms, as shown below, can be seen on the “Alarms Screen” on page 7-87.

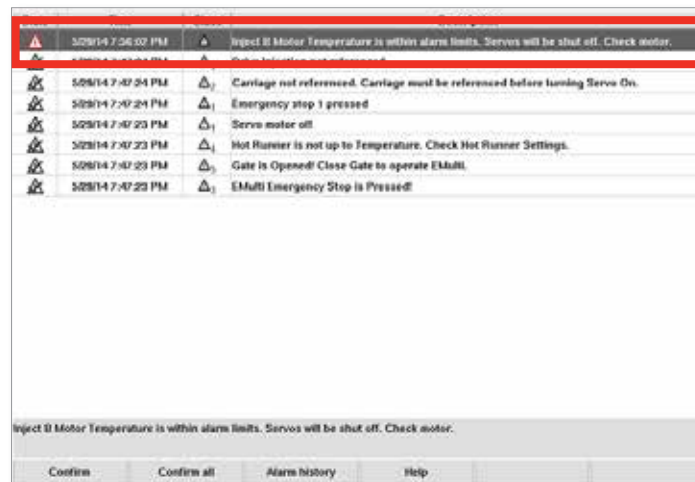

Figure 10-1 Alarms screen with motor temperature alarm

10.6 Troubleshoot the Control System

The control system has several features, which provide an early diagnosis of faults in the control system.

If the system detects any malfunctions, it displays an error message on the Alarm screen.

If the system detects any abnormal condition it displays a warning message on the Alarm screen.

See “Table 10-1 Fault and Warning Messages” on page 9-3. and “Table 10-2 Integrated HRC Warning Messages” on page 9-4.

10.6.1 Fault and Warning Messages

Any of the messages from Table 10-1 or Table 10-2 may be displayed on the Fault Indication line.

Table 10-1 Fault and Warning Messages		
Error Message	Cause	Action
AUTO	The controller has detected a T/C failure and automatically switched this zone to manual. It is using recorded settings to maintain the zone temperature.	Check from the tool back to the controller for a disconnected thermocouple.
	(Note: this will only be seen if you have selected Auto/Manual Mode Enable)	
ERR!	No temperature rise has been detected in that zone.	Check thermocouple wiring, it may be reversed. Heater wiring may be faulty or element may be open circuit.
FUSE	The fuse for that zone has failed. Note: a fuse can only fail due to a fault external to the controller. Identify and rectify the fault before replacing the fuse.	Replace the fuse with one of the same rating and type, i.e. High Rupture Current load fuse. The blown fuse is located either on the control card or on the off-board triac module (If fitted).
GND	The system has detected an earth fault.	Check your heater wiring for a low impedance path to earth.
HELP	There is a system failure	Please contact <i>Mold-Masters Systems</i> .
HIGH	The water-flow sensor has detected a high flow rate.	Check that the coolant water system is not blocked or leaking.
LOW	The water-flow sensor has detected a low flow rate.	
LINE	No mains supply synchronisation pulses being received.	Check supply wiring for presence of all three phases.
LOAD	No load on that zone. Only occurs when in manual closed loop mode where the current is pre-set. The current sensing circuit has not detected a current flow; therefore, the zone is flagged as not having a load.	Isolate the system supply and check the connections between the controller and the tool heaters. Also, check the heater for continuity.
OVER	The RTD zone has detected a temperature in excess of 99°C.	Check the wiring to see that there is no fault. Check that a different RTD has not been fitted.
N/Z	The controller card in this rack position is not responding.	Check card for faults.
NONE	A Zone type appears not to be selected for the card.	There is a communications problem. Try a replacement controller card.

Fault and Warning Messages - continued

Table 10-1 Fault and Warning Messages		
Error Message	Cause	Action
REV	The card has detected an abnormal input at the T/C termination that indicates a shorted or reversed thermocouple.	If the REV alarm persists then you should switch off the controller and investigate the offending zone. Alternatively you could slave the offending zone to a good zone until you have time to clear the fault.
T/C	An open circuit thermocouple has been detected.	For immediate recovery you can either slave that control zone to an adjacent zone or change to open loop control. Later, check to see whether the input fuse on the control card has ruptured or, if the fuse is good, replace the thermocouple.
TRC	Triac fault. This can only occur when in manual mode and automatic mode, where the current is pre-set manually. If for instance, the triac output current is higher than the set point, the controller attempts to reduce output to the level required. If it fails the triac may have failed and it is flagged as faulty.	Check the current output on the channel. If the triac has failed, return to <i>Mold-Masters</i> for repair.

Table 10-2 Integrated HRC Warning Messages	
Warning Message	Abnormal Condition
MAN	The control zone is in manual mode.
S #	The zone is slaved to another control zone, where # represents the number of that zone, i.e. S 2 means the zone is slaved to Zone 2. The same power is being sent to both zones. In the Display page, the set point displayed on the selected zone is the same as that on the slave zone.
TEST	Displayed when the zone is in diagnostic test mode.
WARN	If during the test procedure a temperature interaction is found between zones, this message is displayed.
FAIL	The zone under test has failed.
OK	The zone has passed testing.

10.7 Back Feed Protection (Injection Pawl) (optional)

The injection stop pawl is a device that prevents uncontrolled backwards motion of the screw.

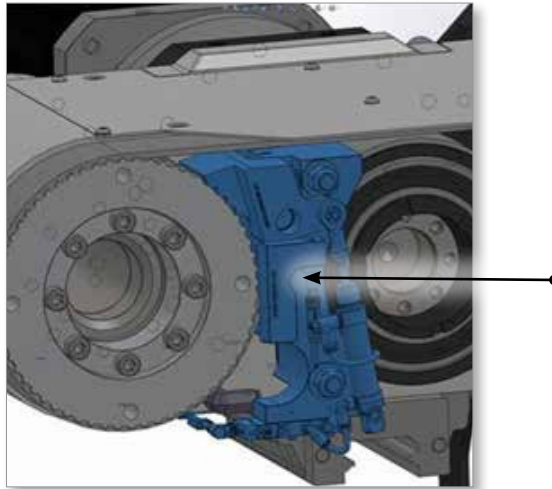

Figure 10-2 Injection pawl

The injection pawl is automatically engaged when the servo drives are disabled or when there is an emergency stop. When the pawl is engaged, it prevents the injection housing from moving backwards. When power is applied to the valve of the injection pawl, the cylinder retracts, disengaging the pawl. When the pawl is disengaged, the pawl position sensor illuminates and a signal is sent to the controller.

10.7.1 Injection Pawl Alarms

1. Screw pushed back during injection
2. Screw exceeded target position for decompression after recovery
3. Screw exceeded absolute injection stroke limit

An emergency stop (E-Stop) is triggered when alarm 3 occurs (the screw is pushed back to exceed the stroke limit).

10.7.2 Entering setup mode

1. Press the F1 button on the E-Multi panel.

The F1 LED will blink. The setup mode icon will appear in the right bar.

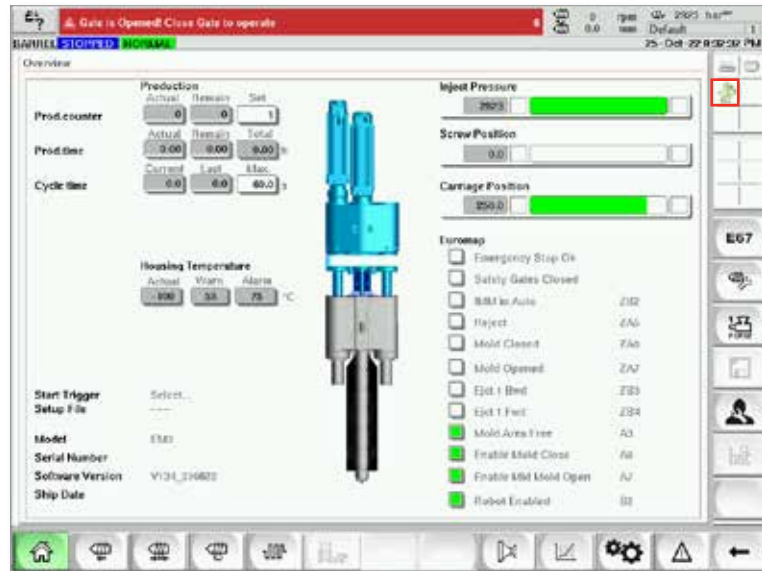

10.7.3 Removing an interlock

When an injection pawl alarm occurs, an interlock prevents the E-Multi from resuming the automatic mode of operation. To remove an interlock, do the following.

1. Enter setup mode. See section 9.7.2 Entering setup mode.
2. Tap the Settings button on the bottom bar.

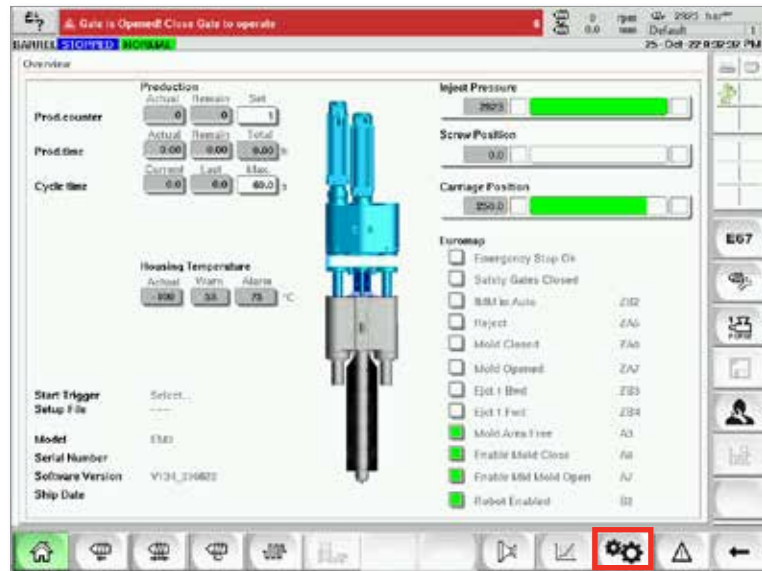

3. Tap the Calibration button.

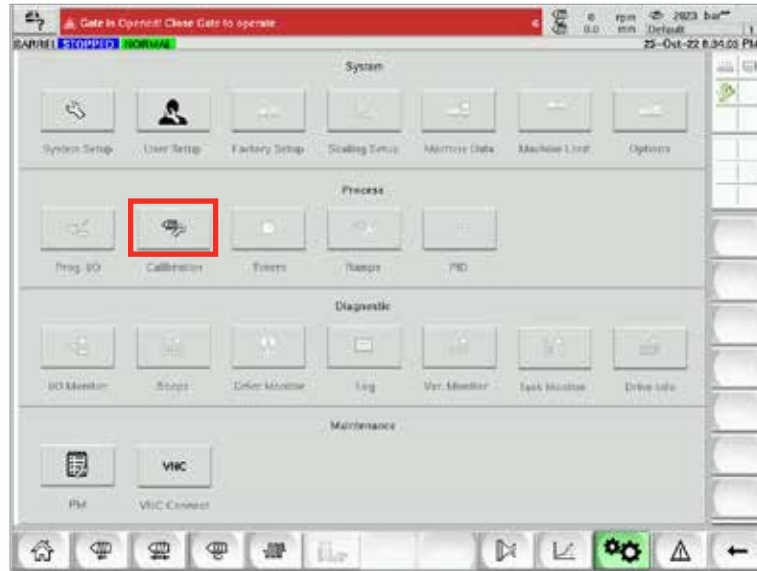

4. If you need to engage the lock pawl, tap the Engage button.



5. If you need to disengage the lock pawl, tap the Disengage button.



6. To recover from alarms 1 and 2, contact Mold-Masters to get a recovery password. (See section "10.7.1 Injection Pawl Alarms" on page 9-5 for information about injection pawl alarms.)
7. Enter the recovery password, and tap the Accept button.



8. To recover from alarm 3 (E-Stop):
 - a) Press the E-Stop recovery button to enable the drive and allow the injection unit to move.
 - b) Contact Mold-Masters to have a technician unlock the machine.
 - c) Re-reference the injection axis.

Appendix A

Purge Guard (optional)

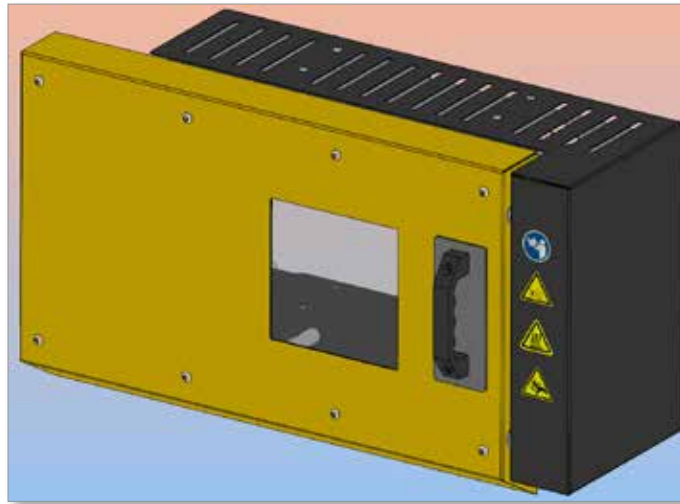

The E-Multi controller has an input for monitoring the state of the purge guard. A switch on the purge guard sends a signal to the input when the purge guard is closed. The E-Multi controller has a dry contact that mimics the state of the purge guard switch. The contact is wired in series with the IMM purge guard so that the E-Multi purge guard functions in the same way as the IMM purge guard.

Open the purge guard

1. Pull up the handle to unlock the guard, and slide the purge guard to the left.

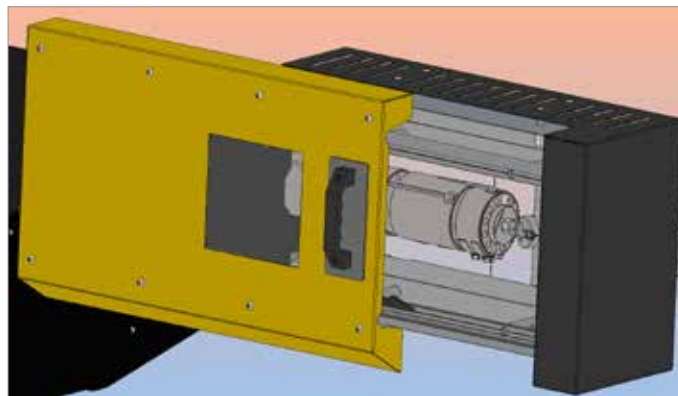

When the purge guard is opened, an alarm is generated and shown on the top bar of the E-Multi controller screen.

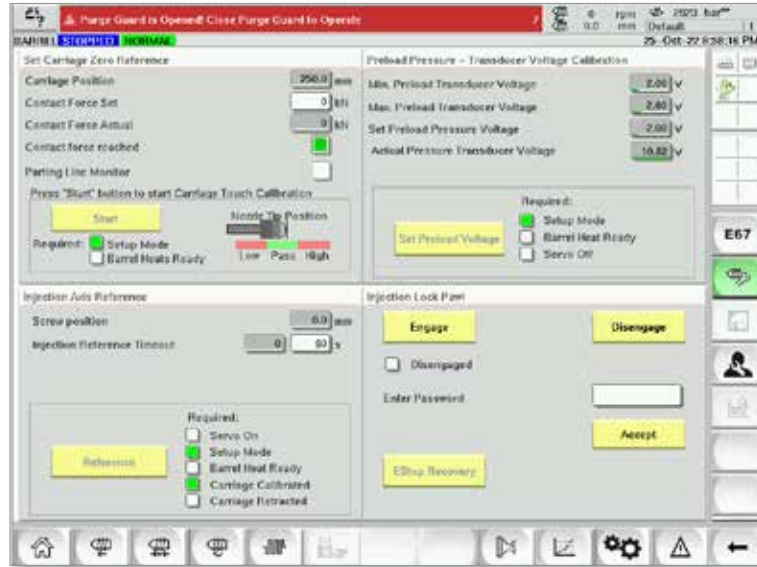

Remove a purge alarm (close the purge guard)

1. Use the handle of the purge guard to slide the purge guard fully to the right.

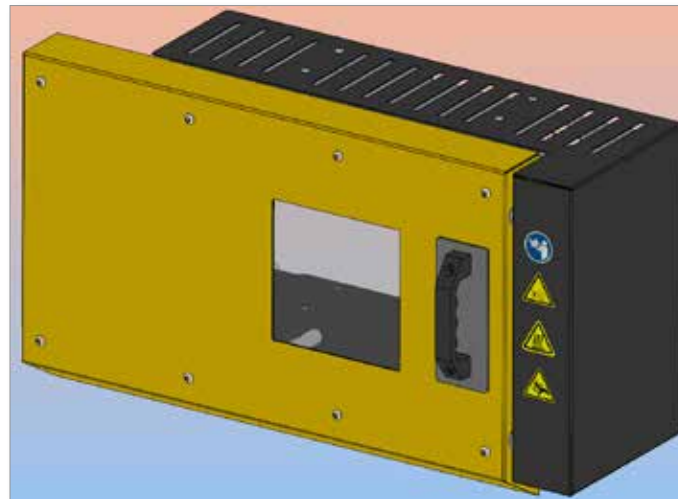

The purge guard alarm is removed from the top bar of the controller screen.

Index

A

Active Movement Icons 7-5

B

Barrel Temperature Settings - Keba Style 7-21, 7-22

Barrel Temperature Settings - Mold-Masters Screen 7-23

C

Cabinet Mounted Control Buttons 7-2

Cycle Start Trigger Tab 7-91

E

E-Drive Control 7-38

Euromap E67 Screen 7-91, 7-94

F

Force Reject When Not in Auto 7-92

H

Heater Continuity Check 9-1

Hold Settings Screen 7-16

Hot Runner Temperature Control 7-27

Monitor Screen 7-28

Utilities Screen 7-36

I

IMM Screw Tab 7-92

Injection Axis Referencing 9-6

Injection Settings Screen 7-13

Input and Output Signals 7-93

M

Machine Specification Screen 7-60, 7-61

Main Settings Screen 7-60, 7-61

Mold Area Free Setup Tab 7-92

Mold Data 7-89

N

New Software Installation 9-10

O

Overview Screen 7-9

P

Process Data (PD) Protocol Screen 7-58

Production Graph Screen 7-52

Purge Guard A-01

R

Recovery Settings Screen 7-18

Release Details, Document 1-1

S

Safety

Lockout 3-10

Safety Symbols

General Descriptions 3-8

Screen Navigation Button Bar 7-6

Screen Navigation Buttons 7-6

Servicing and Repairing Your Controller 9-7

Status Icons 7-5

T

Touch Screen Interface 7-3, 7-38, 7-40, 7-52

Transducer Output Check 9-1

Troubleshooting the Control System 9-2

V

Valve Gate Settings Screen 7-44

Vibrator Valve Check 9-1

NORTH AMERICA

CANADA (Global HQ)
tel: +1 905 877 0185
e: canada@moldmasters.com

U.S.A.
tel: +1 248 544 5710
e: usa@moldmasters.com

SOUTH AMERICA

BRAZIL (Regional HQ)
tel: +55 19 3518 4040
e: brazil@moldmasters.com

MEXICO
tel: +52 442 713 5661 (sales)
e: mexico@moldmasters.com

EUROPE

GERMANY (Regional HQ)
tel: +49 7221 50990
e: germany@moldmasters.com

UNITED KINGDOM
tel: +44 1432 265768
e: uk@moldmasters.com

AUSTRIA
tel: +43 7582 51877
e: austria@moldmasters.com

SPAIN
tel: +34 93 575 41 29
e: spain@moldmasters.com

POLAND
tel: +48 669 180 888 (sales)
e: poland@moldmasters.com

CZECH REPUBLIC
tel: +420 571 619 017
e: czech@moldmasters.com

FRANCE
tel: +33 (0)1 78 05 40 20
e: france@moldmasters.com

TURKEY
tel: +90 216 577 32 44
e: turkey@moldmasters.com

ITALY
tel: +39 049 501 99 55
e: italy@moldmasters.com

ASIA

CHINA (Regional HQ)
tel: +86 512 86162882
e: china@moldmasters.com

KOREA
tel: +82 31 431 4756
e: korea@moldmasters.com

JAPAN
tel: +81 44 986 2101
e: japan@moldmasters.com

SINGAPORE*
tel: +65 6261 7793
e: singapore@moldmasters.com

*Coverage includes Southeast Asia

INDIA (Regional HQ)
tel: +91 422 423 4888
e: india@moldmasters.com

OCEANIA

AUSTRALIA
tel: +61 407 638 314
e: australia@moldmasters.com

NEW ZEALAND
tel: +61 407 638 314
e: newzealand@moldmasters.com